

**MT1000A
Network Master Pro
OTDR Modules
Operation Manual**

Ninth Edition

For safety and warning information, please read this manual before attempting to use the equipment. Keep this manual with the equipment.

ANRITSU CORPORATION

Document No. M-W3810AE-9.0

MT1000A Network Master Pro
OTDR Modules
Operation Manual

25 November 2015 (First Edition)
23 June 2017 (Ninth Edition)

© Copyright 2015-2017, ANRITSU CORPORATION.
All rights reserved. No part of this manual may be reproduced without the prior
written permission of the publisher.
The contents of this manual may be changed without prior notice.
Printed in Japan

About This Manual

The documentation for MT1000A Network Master Pro applies to the instrument with the MU100020A, MU100021A, or MU100022A OTDR Module installed. This operation manual describes both the basic operation of the instrument as well as the operations available via interface options and predefined applications/tests.

MT1000A Network Master Pro OTDR Modules Operation Manual (this manual)

Operations for the MT1000A Network Master Pro mainframe with OTDR module (MU100020A, MU100021A, and MU100022A) are described.

MT1000A Network Master Pro OTDR Modules Quick Reference Guide

A printed quick user's guide that introduces the basic operation of the instrument.

MT1000A Network Master Pro OTDR Modules Remote Scripting Operation Manual

Operations of the command-based Remote Control function are described.

Manual structure

The contents of the manual is structured in the following way:

- Chapter 1 - Introduction
- Chapter 2 - Configuration
- Chapter 3 - Human-Machine-Interface
- Chapter 4 - Graphical User Interface
- Chapter 5 - Optical Fibre Test Applications
- Chapter 6 - Utility Applications
- Chapter 7 - Performance Test and Calibration
- Chapter 8 - Specifications
- Chapter 9 - Support

Chapter 4 consists of a general introduction to the GUI. Chapters 5 contains descriptions of each screen, sub-screen and major dialog box. The descriptions are provided in the following order:

Setup and result screens for each application. The applications are described in the same order as they appear on the application selector screen.

Measurement condition setup screens

This operation manual is intended for those who have the basic knowledge of the following:

Basic knowledge of optical fiber communication, handling optical parts and optical fibers

Table of Contents

| | |
|--|-----------|
| 0 Table of Contents | 4 |
| 1 Introduction | 9 |
| 1.1 Mainframe | 10 |
| 1.2 OTDR Module 1310/1550nm SMF (MU100020A) | 11 |
| 1.3 OTDR Module 1310/1550/850/1300nm SMF/MMF (MU100021A) | 11 |
| 1.4 OTDR Module 1310/1550/1625nm SMF (MU100022A) | 11 |
| 1.5 Symbols and Conventions | 12 |
| 1.5.1 Symbols Used in Manual | 12 |
| 1.5.2 Safety Symbols Used on Equipment | 12 |
| 1.5.3 Notes | 12 |
| 1.5.4 Hints | 13 |
| 1.5.5 Option | 13 |
| 1.6 For Safety | 14 |
| 1.6.1 Dangers | 14 |
| 1.6.2 Warnings | 14 |
| 1.6.3 Cautions | 16 |
| 1.6.4 Cautions against Computer Virus Infection | 17 |
| 1.7 Precautions | 18 |
| 1.7.1 Installation | 18 |
| 1.7.2 Ventilation | 18 |
| 1.7.3 ESD (Electrostatic Discharge) | 19 |
| 1.7.4 Optical Connectors | 20 |
| 1.7.5 Cautions on Handling Optical Fiber Cables | 20 |
| 1.7.6 Countries and Regions Permitting WLAN Use | 22 |
| 2 Configuration | 23 |
| 2.1 Delivered Accessories | 24 |
| 2.1.1 Standard Accessories | 24 |
| 2.1.2 Optional Accessories | 24 |
| 2.2 Mains Power Adapter | 25 |
| 2.2.1 Connecting Mains Power Adapter | 25 |
| 2.3 Rechargeable Battery | 26 |
| 2.3.1 Installing or Replacing Battery | 26 |
| 2.3.2 Charging Battery in Fast Mode | 27 |
| 2.3.3 Charging Battery in Normal Mode | 27 |
| 2.3.4 Battery Status Information | 27 |
| 2.4 Optical Fibers | 29 |
| 2.5 Support Stand and Carrying Strap | 30 |
| 2.5.1 Support Stand | 30 |
| 2.5.2 Carrying Strap and Handle | 30 |
| 2.6 Modules Configuration | 34 |
| 2.7 Attaching the Modules | 35 |
| 2.7.1 Replacing the MU100010A 10G Multirate modules | 35 |
| 2.7.2 Attaching OTDR module with 10G Multirate module | 35 |
| 2.7.3 Attaching OTDR module without 10G Multirate module | 37 |
| 3 Human-Machine-Interface | 39 |
| 3.1 Touch Screen Display | 40 |
| 3.2 Key Operation | 41 |
| 3.2.1 Power Button | 41 |
| 3.3 Head Set | 43 |
| 3.4 Connector Panel | 44 |
| 3.4.1 Test Interfaces | 44 |
| 3.4.2 Service Interfaces | 45 |
| 3.4.3 Optical Connector/Optical Adapter Cleaning | 45 |
| 3.5 Command-Based Remote Control | 48 |

| | |
|--|------------|
| 3.6 File Access via USB Interface | 48 |
| 3.7 File Access via Ethernet Interface | 49 |
| 3.7.1 Accessing files in Network Master from the PC | 49 |
| 3.7.2 Mounting the Shared Folder of Networked PC to the Network Master | 49 |
| 3.8 GPS Receiver | 51 |
| 3.8.1 G0325A GPS Receiver | 51 |
| 3.8.2 Operating GPS Receiver | 51 |
| 4 Graphical User Interface | 53 |
| 4.1 General Handling of the GUI | 54 |
| 4.1.1 GUI Concept | 54 |
| 4.1.2 Navigating in the GUI | 55 |
| 4.1.3 Layout of the GUI Screens | 56 |
| 4.1.4 Keypads for Entering Text in Fields | 63 |
| 4.2 Toolbars | 64 |
| 4.2.1 Instrument Toolbar | 64 |
| 4.2.2 Application Toolbar | 76 |
| 4.3 Startup and Switch-off Sequences | 81 |
| 4.3.1 Instrument Startup | 81 |
| 4.3.2 Application Startup | 81 |
| 4.3.3 Accessing Previous Tests and Test Results | 81 |
| 4.3.4 Closing an Application | 82 |
| 4.3.5 Switching Off the Instrument | 82 |
| 5 Optical Fiber Testing Applications | 83 |
| 5.1 Standard OTDR | 84 |
| 5.1.1 Measurement Condition Setup | 84 |
| 5.1.2 Test Setup | 93 |
| 5.1.3 Test Results | 97 |
| 5.1.4 Measurements | 109 |
| 5.2 FTTA | 118 |
| 5.2.1 Measurement Condition Setup | 118 |
| 5.2.2 Test Setup | 118 |
| 5.2.3 Test Result | 119 |
| 5.3 Construction | 122 |
| 5.3.1 Application Toolbar | 122 |
| 5.3.2 Measurement Condition Setup | 123 |
| 5.3.3 Test Setup | 136 |
| 5.3.4 Test Result | 137 |
| 5.4 OLTS | 143 |
| 5.4.1 Loss Test Setup | 145 |
| 5.4.2 Loss Table | 147 |
| 6 Utility Applications | 149 |
| 6.1 Scenario | 150 |
| 6.1.1 Scenario Manager | 150 |
| 6.1.2 Running the Scenario | 152 |
| 6.2 GPS | 154 |
| 6.2.1 Test Setup | 154 |
| 6.2.2 Test Results | 154 |
| 6.3 PDF Viewer | 157 |
| 6.4 VIP | 158 |
| 6.4.1 Application Toolbar | 158 |
| 6.4.2 Connecting the probe | 159 |
| 6.4.3 Test Setup | 159 |
| 6.4.4 Test Results | 162 |
| 6.5 Wireshark | 164 |
| 7 Performance Test and Calibration | 165 |

| | |
|---|------------|
| 7.1 Performance Test | 166 |
| 7.1.1 Required instruments for performance test | 166 |
| 7.1.2 Wavelength | 168 |
| 7.1.3 Pulse Width | 169 |
| 7.1.4 Dynamic Range | 170 |
| 7.1.5 Distance Measurement Accuracy | 171 |
| 7.1.6 Linearity | 173 |
| 7.1.7 Dead Zone | 175 |
| 7.1.8 Optical Power Level and Wavelength of VFL | 178 |
| 7.1.9 Optical Power Level and Wavelength of Light Source | 179 |
| 7.1.10 Optical Power Meter Measurement Accuracy | 180 |
| 7.2 Calibration | 181 |
| 7.2.1 Backscatter coefficient level calibration | 181 |
| 7.2.2 Measurement accuracy calibration of optical power meter | 182 |
| 7.3 Performance Test Result Sheet | 183 |
| 8 Specifications | 191 |
| 8.1 MT1000A | 192 |
| 8.1.1 Configuration | 192 |
| 8.1.2 External Interfaces | 193 |
| 8.1.3 Other Interfaces | 193 |
| 8.1.4 Environment Performance | 194 |
| 8.1.5 Mechanical Performance | 194 |
| 8.2 MU100020A OTDR Module 1310/1550nm SMF | 195 |
| 8.2.1 Configuration | 195 |
| 8.2.2 OTDR | 195 |
| 8.2.3 Optical Power Meter | 197 |
| 8.2.4 Light Source | 198 |
| 8.2.5 VFL (Option 002) | 198 |
| 8.2.6 Environment Performance | 199 |
| 8.2.7 Mechanical Performance | 199 |
| 8.3 MU100021A OTDR Module 1310/1550/850/1300nm SMF/MMF | 200 |
| 8.3.1 Configuration | 200 |
| 8.3.2 OTDR | 200 |
| 8.3.3 Optical Power Meter | 202 |
| 8.3.4 Light Source | 203 |
| 8.3.5 VFL (Option 002) | 203 |
| 8.3.6 Environment Performance | 204 |
| 8.3.7 Mechanical Performance | 204 |
| 8.4 MU100022A OTDR Module 1310/1550/1625nm SMF | 205 |
| 8.4.1 Configuration | 205 |
| 8.4.2 OTDR | 205 |
| 8.4.3 Optical Power Meter | 207 |
| 8.4.4 Light Source | 207 |
| 8.4.5 VFL (Option 002) | 208 |
| 8.4.6 Environment Performance | 208 |
| 8.4.7 Mechanical Performance | 209 |
| 9 Support | 211 |
| 9.1 Maintenance and Cleaning | 212 |
| 9.1.1 Maintenance | 212 |
| 9.1.2 Cleaning | 212 |
| 9.2 Notes On Storage | 213 |
| 9.3 Formatting the data area in the Network Master | 214 |
| 9.4 Upgrading the Software | 215 |
| 9.5 Support and Service Assistance | 216 |
| 9.5.1 Before you obtain assistance | 216 |
| 9.5.2 Obtaining Support or Service Assistance | 216 |
| 9.6 Transporting and Disposal | 217 |

| | |
|---|------------|
| 9.6.1 Repackaging | 217 |
| 9.6.2 Transporting | 217 |
| 9.6.3 Disposal | 217 |
| 9.7 Special Information | 218 |
| 9.7.1 Equipment Certificate | 218 |
| 9.7.2 Anritsu Warranty | 218 |
| 9.7.3 Anritsu Corporation Contact | 219 |
| 9.7.4 Licensing Information | 219 |
| 9.7.5 Availability of Source Code | 219 |
| 9.8 Software License Document | 220 |
| 9.9 EULA License Document | 224 |
| 9.10 CE Conformity Marking | 226 |
| 9.10.1 Product Model | 226 |
| 9.10.2 Applied Directive | 226 |
| 9.10.3 Applied Standards | 226 |
| 9.10.4 Authorized Representative | 227 |
| 9.10.5 CE Declaration | 228 |
| 9.11 RCM Conformity Marking | 229 |
| 9.11.1 Product Model | 229 |
| 9.11.2 Applied Standards | 229 |
| 9.12 Laser Safety | 230 |
| 9.12.1 Laser Safety Classifications | 230 |
| 9.12.2 Indication Labels on Product | 233 |
| 9.12.3 Laser Radiation Markings | 233 |
| 9.13 Wireless Certification | 237 |
| 9.13.1 Japan MIC | 237 |
| 9.13.2 North America (USA FCC and Canada IC) | 237 |
| 9.13.3 Europe CE | 238 |
| 9.13.4 Brazil ANATEL | 238 |
| 9.13.5 China SRRC | 239 |
| 9.13.6 Indonesia SDPPI | 239 |
| 9.13.7 Israel MoC | 239 |
| 9.13.8 Mexico IFETEL | 240 |
| 9.13.9 Philippines NTC | 240 |
| 9.13.10 Russia CU Scheme and Minsvyaz | 240 |
| 9.13.11 Singapore IMDA | 240 |
| 9.13.12 Thailand NTC | 240 |
| 9.14 Declarations | 241 |
| 9.14.1 Notes on Export Management | 241 |
| 9.14.2 Information for EU and EFTA Customers Only | 241 |
| 9.14.3 Information for U.S. Customers Only | 241 |
| 9.14.4 Information for the Chinese Market Only | 242 |

1 Introduction

This chapter provides a general introduction to the MT1000A Network Master Pro, and explains the symbols and conventions used in this manual.

1.1 Mainframe

The MT1000A Network Master Pro (hereafter called *the Network Master* and sometimes *the instrument*) is a battery-powered multipurpose telecommunications test instrument for field use. It is a tool for a wide range of applications from fast first-aid troubleshooting to comprehensive, in-depth analysis of transmission problems. The installed options enable the Network Master to be used both as a full-featured transmission line quality tester and as an advanced signaling analyzer.

The Network Master features a wide TFT LCD display with touch screen interface, where results are easily read and color coding and graphical symbols aid the users in system setup and results analysis. The Network Master also allows users to store applications settings to reduce time for future configurations. For fast and efficient data transfer and external communication, the Network Master houses LAN interface, *Bluetooth*[®] and three USB ports.

Fault location is greatly facilitated by the high degree of portability of the robust Network Master, allowing measurements to be taken at any suitable measuring point. Accordingly, the Network Master can be powered either by a rechargeable and replaceable intelligent high-capacity Li-Ion battery, or via mains adapter for long-term measurements.

Altogether, these features guarantee the supreme functionality of the Network Master, allowing both convenience and optimal user-friendly operation.

For latest information, refer to the homepage below.

<http://www.anritsu.com/en-us/test-measurement/products/mt1000a>



1.2 OTDR Module 1310/1550nm SMF (MU100020A)

MU100020A OTDR module is the model dedicated for single mode fiber testing. For the communication through a single mode fiber, 1310 nm or 1550 nm wavelength optical signal is used. The MU100020A is able to output these optical signals for OTDR test or the light source. MU100020A equips the optical power meter which is convenient for checking the optical power level. By combining with the light source and the optical power meter, the optical loss can measure the optical loss of an optical device. This application is the optical loss test set (OLTS).



Visual Fault Locator (VFL) Option

It is a visible (red) light source. Since the light is visible, it is useful for locating faults in the dead zone by visually checking for diffuse escaping light.



1.3 OTDR Module 1310/1550/850/1300nm SMF/MMF (MU100021A)

MU100021A OTDR module is the model available to test both of single mode fiber and multi mode fiber. Optical wavelength used for the communication through a multi mode fiber is 850 nm or 1300 nm.

1.4 OTDR Module 1310/1550/1625nm SMF (MU100022A)

MU100022A OTDR module has the 1625 nm wavelength light source in addition to 1310 nm and 1550 nm wavelength light source. Using the signal of 1625 nm wavelength allows the OTDR test which does not have an effect on the communication.

1.5 Symbols and Conventions

1.5.1 Symbols Used in Manual

To prevent the risk of personal injury or loss related to equipment malfunction, Anritsu Corporation uses the following safety symbols to indicate safety-related information. Ensure that you clearly understand the meanings of the symbols BEFORE using the equipment. Some or all of the following symbols may be used on all Anritsu equipment. In addition, there may be other labels attached to products that are not shown in the diagrams in this manual.



DANGER

This indicates a very dangerous procedure that could result in serious injury or death if not performed properly.



WARNING

This indicates a hazardous procedure that could result in serious injury or death if not performed properly.



CAUTION

This indicates a hazardous procedure or danger that could result in light-to-severe injury, or loss related to equipment malfunction, if proper precautions are not taken.

1.5.2 Safety Symbols Used on Equipment

The following safety symbols are used on Anritsu equipment near operation locations to provide information about safety items and operation precautions. Ensure that you clearly understand the meanings of the symbols and take the necessary precautions BEFORE using the equipment.



This indicates a prohibited operation. The prohibited operation is indicated symbolically in or near the barred circle.



This indicates an obligatory safety precaution. The obligatory operation is indicated symbolically in or near the circle.



This indicates a warning or caution. The contents are indicated symbolically in or near the triangle.



This indicates a note. The contents are described in the box.



These indicate that the marked part should be recycled.

A number of typographical conventions are used for easy spotting of information. Examples below are shown in grey boxes in this section only to indicate that they are 'examples'.

1.5.3 Notes



The Note symbol indicates information, procedures or recommendations that need to be followed to make correct measurements etc. Note text is written in italics to separate the information from the other text elements on a page.

1.5.4 Hints



The Hint symbol indicates information that should be treated as hints, suggestions, recommendations etc. Hint text is written in italics to separate the information from the other text elements on a page.

1.5.5 Option



The Option symbol indicates that the information described covers an option (hardware and software) and that this option must be installed before use. Text is written in italics to separate the information from the other text elements on a page.

1.6 For Safety

This section contains warnings which should be followed to avoid personal injury, product damage, as well as damage to the environment.

1.6.1 Dangers

DANGER

Replacing Battery



- When replacing the battery, use the specified battery and insert it with the correct polarity. If the wrong battery is used, or if the battery is inserted with reversed polarity, there is a risk of explosion causing severe injury or death.

FOR CALIFORNIA USA ONLY

This product contains a CR Coin Lithium Battery which contains Perchlorate Material - special handling may apply, see www.dtsc.ca.gov/hazardouswaste/perchlorate.

Battery Disposal

- DO NOT expose batteries to heat or fire. This is dangerous and can result in explosions or fire. Heating batteries may cause them to leak or explode.
-

1.6.2 Warnings

WARNING



- ALWAYS refer to the operation manual when working near locations at which the alert mark shown on the left is attached. If the advice in the operation manual is not followed, there is a risk of personal injury or reduced equipment performance. The alert mark shown on the left may also be used with other marks and descriptions to indicate other dangers.

- Overvoltage Category

This equipment complies with overvoltage category II defined in IEC 61010. DO NOT connect this equipment to the power supply of overvoltage category III or IV.

- Laser radiation warning

NEVER look directly into the cable connector on the equipment nor into the end of a cable connected to the equipment. There is a risk of injury if laser radiation enters the eye.

The Laser Safety label is attached to the equipment for safety use as indicated in "[Laser Safety](#)".

Repair



- Only qualified service personnel with a knowledge of electrical fire and shock hazards should service this equipment. This equipment cannot be repaired by the operator. DO NOT attempt to remove the equipment covers or unit covers or to disassemble internal components. In addition, there is a risk of damage to precision components.

Calibration



- The performance-guarantee seal verifies the integrity of the equipment. To ensure the continued integrity of the equipment, only Anritsu service personnel, or service personnel of an Anritsu sales representative, should break this seal to repair or calibrate the equipment. Be careful not to break the seal by opening the equipment or unit covers. If the performance-guarantee seal is broken by you or a third party, the performance of the equipment cannot be guaranteed.

Battery Fluid

- DO NOT short the battery terminals and never attempt to disassemble the battery or dispose of it in a fire. If the battery is damaged by any of these actions, the battery fluid may leak. This fluid is poisonous. DO NOT touch the battery fluid, ingest it, or get in your eyes. If it is accidentally ingested, spit it out immediately, rinse your mouth with water and seek medical help. If it enters your eyes accidentally, do not rub your eyes, rinse them with clean running water and seek medical help. If the liquid gets on your skin or clothes, wash it off carefully and thoroughly with clean water.

LCD

- This equipment uses a Liquid Crystal Display (LCD). DO NOT subject the equipment to excessive force or drop it. If the LCD is subjected to strong mechanical shock, it may break and liquid may leak. This liquid is very caustic and poisonous. DO NOT touch it, ingest it, or get in your eyes. If it is ingested accidentally, spit it out immediately, rinse your mouth with water and seek medical help. If it enters your eyes accidentally, do not rub your eyes, rinse them with clean running water and seek medical help. If the liquid gets on your skin or clothes, wash it off carefully and thoroughly with soap and water.
-

1.6.3 Cautions

CAUTION

Replacing Memory Back-up Battery

This equipment uses a Poly-carbomonofluoride lithium battery to back up the memory. This battery must be replaced by service personnel when it has reached the end of its useful life; contact the Anritsu sales section or your nearest representative.

Note: The battery used in this equipment has a maximum useful life of 8 years. It should be replaced before this period has elapsed.

The life of the battery will vary depending on the length of equipment usage and the operating environment.

The following conditions may be observed if the battery has expired:

- When power to the equipment is supplied, the time display may no longer match the actual time.
- Parameter and data settings may not be retained when the power to the equipment is cut.

External Storage

This equipment uses a USB memory as external storage media for storing data and programs.

If this media is mishandled or becomes faulty, important data may be lost. It is recommended to periodically back up all important data and programs to protect them from being lost accidentally.

Anritsu will not be held responsible for lost data.

Pay careful attention to the following points:

- Never remove the USB memory from the equipment while it is being accessed.
- The USB memory may be damaged by static electric charges.
- Anritsu has thoroughly tested all external storage media shipped with this equipment. Users should note that external storage media not shipped with this equipment may not have been tested by Anritsu, thus Anritsu cannot guarantee the performance or suitability of such media.

Lifetime of Parts

The life span of certain parts used in this equipment is determined by the operating time or the power-on time. Due consideration should be given to the life spans of these parts when performing continuous operation over an extended period. The safety of the equipment cannot be guaranteed if component parts are used beyond their life spans. These parts must be replaced at the customer's expense even if within the guaranteed period described in Warranty at the end of this manual.

For details on life-span, refer to the corresponding section in this manual.

- LCD: Brightness at 50% after 40,000hrs
- Battery pack Capacity: 70% after 300 charge/discharge cycles

Use in Residential Environment

This equipment is designed for an industrial environment. In a residential environment, this equipment may cause radio interference in which case the user may be required to take adequate measures.

Use in Corrosive Atmospheres

Exposure to corrosive gases such as hydrogen sulfide, sulfurous acid, and hydrogen chloride will cause faults and failures.

Note that some organic solvents release corrosive gases.

1.6.4 Cautions against Computer Virus Infection

Copying files and data

Only files that have been provided directly from Anritsu or generated using Anritsu equipment should be copied to the instrument.

All other required files should be transferred by means of USB media after undergoing a thorough virus check.

Adding software

Do not download or install software that has not been specifically recommended or licensed by Anritsu.

Network connections

Ensure that the network has sufficient anti-virus security protection in place.

1.7 Precautions

This section contains some precautions which should be followed to avoid damage or malfunction due to incorrect use, handling and transportation of the Network Master.

1.7.1 Installation

Install MT1000A horizontally in a stable place.

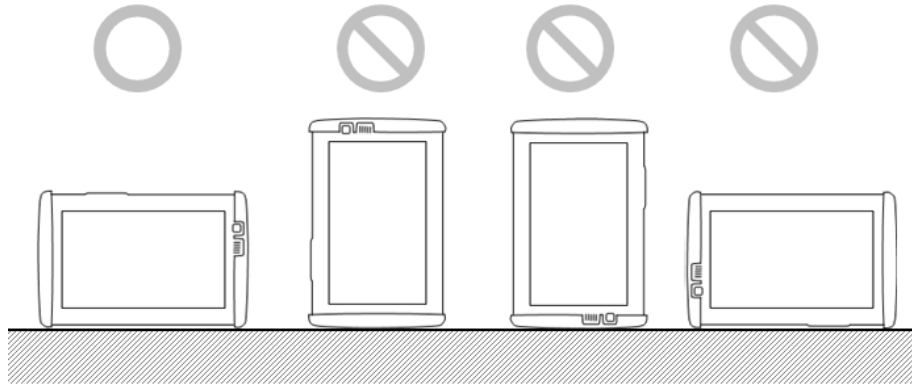

⚠ CAUTION

If the MT1000A is not installed in a "good" direction as above, a small shock may turn it over and harm the user.

MT1000A equips the support stand on the rear panel. When using MT1000A on a desk, open the [support stand](#) on the rear the panel

1.7.2 Ventilation

The instrument has built-in fans, to prevent the temperature to rise inside the instrument.

⚠ CAUTION

Be sure not to block the ventilation holes.

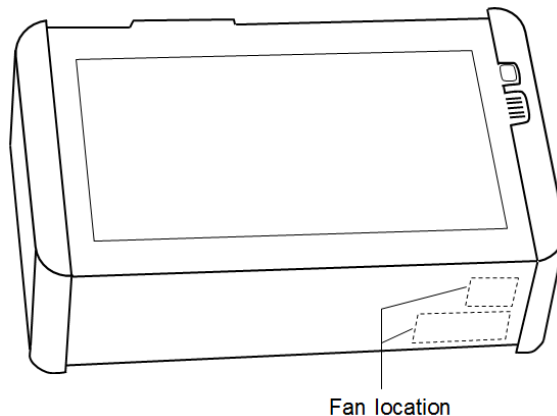

In this instrument, cooling air is taken in through the side panel, and hot air is exhausted through the bottom panel. When using MT1000A on a desk, open the [support stand](#) on the rear the panel

1.7.3 ESD (Electrostatic Discharge)

Modules and options for the Network Master contain electronic devices that are sensitive to ESD (Electro Static Discharge). Therefore, all ESD sensitive items are delivered from Anritsu in antistatic shielding packages.

Electrostatic discharge during installation can result in destruction or degradation of these devices. The damage may lead to equipment failure later. When you install or remove modules, it is your responsibility to control ESD. To control ESD, take the issues described below into consideration.

CAUTION

Avoid build-up of electrostatic charge

- Keep your workplace clear of any item that can generate electrostatic charges, e.g. all items that are not made of antistatic materials.

Minimize the exposure to ESD

- Keep ESD sensitive items in antistatic shielding packaging as long as possible.
- Do not remove ESD sensitive items from equipment or the antistatic shielding packaging unless you are connected to the equipment with a grounding wrist strap (as described later).
- Return ESD sensitive items to antistatic shielding packaging.

Keep equipment, the ESD sensitive items and yourself at the same static potential

- If your workplace is already prepared for handling ESD sensitive items, then follow your usual procedure. If not, you should follow the procedure below using a ground wrist strap.
 1. Attach the wrist end of the wrist strap firmly around your wrist and the other end to the equipment chassis or ground plug.
 2. Keep the wrist strap on while you install or remove ESD sensitive items. Do not remove the wrist strap until the ESD sensitive parts are either installed or returned to the antistatic shielding package.
-

1.7.4 Optical Connectors

The optical connectors are very sensitive to contamination. Be aware that contamination of the optical connectors may result in severe loss of signal.

⚠ CAUTION

To prevent contamination of the optical connectors, mount protective caps to seal the optical connectors when no fiber optic cables are connected.

1.7.5 Cautions on Handling Optical Fiber Cables

Optical fiber cables may degrade in performance or be damaged if handled improperly. Note the following points when handling them.

⚠ WARNING

Do not touch the end of a broken optical fiber cable.

The broken optical fiber may pierce the skin, causing injury.



⚠ CAUTION

Do not pull the cable when removing the connector.

Doing so may break the optical fiber inside the cable, or remove the cable sheath from the optical connector.



⚠ CAUTION

Do not excessively bend, fold, or pinch an optical fiber cable.

Doing so may break the optical fiber inside the cable.

Keep the bend radius of an optical fiber cable at 30 mm or more. If the radius is less, optical fiber cable loss will increase.

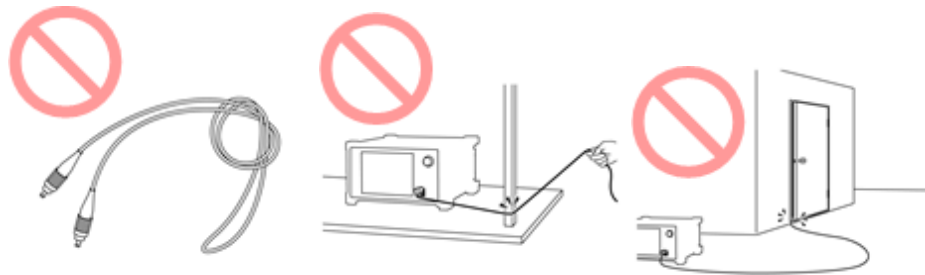

⚠ CAUTION

Do not excessively pull on or twist an optical fiber cable.

Also, do not hang anything by using a cable. Doing so may break the optical fiber inside the cable.



⚠ CAUTION

Be careful not to hit the end of an optical connector against anything hard such as the floor or a desk by dropping the optical fiber cable.

Doing so may damage the connector end and increase connection loss.



⚠ CAUTION

Do not disassemble optical connectors.

Doing so may cause part to break or the performance to degrade.

1.7.6 Countries and Regions Permitting WLAN Use

Use of WLAN is restricted in some countries and regions, and illegal use may be punishable under national or local regulations. To avoid violating WLAN regulations, visit the Anritsu website to check where use is allowed.

<http://www.anritsu.com/ja-JP/test-measurement/support/downloads/brochures-datasheets-and-catalogs/dwl16689>

Note that Anritsu cannot be held liable for any problem arising from WLAN use in other countries and regions.

2 Configuration

This chapter contains information about the included accessories as well as guidelines for connecting the mains adapter, for charging the battery, for attaching the carrying strap, and how to replace the modules.

2.1 Delivered Accessories

The instrument is delivered in a shipment container together with various accessories depending on the order. When unpacking the first time, it is recommended to check these accessories against the list(s) below.

2.1.1 Standard Accessories

The following standard accessories are delivered with the instrument:

| MT1000A | |
|----------------|---|
| J0980 | A-2 Power Cord * ¹ |
| J0981 | B4 Power Cord * ¹ |
| J0982 | C7 Power Cord * ¹ |
| J0983 | S3 Power Cord * ¹ |
| J1027 | P4 Power Cord * ¹ |
| G0310A | LiION Battery |
| G0385A | High Power AC Adapter |
| B0690A | Softbag |
| B0728A | Rear Panel Kit |
| Z1746A | Stylus |
| Z1747A | Carrying Strap |
| Z1748A | Handle |
| Z1817A | Utilities ROM |
| W3935AE | MT1000A Transport Modules Quick Reference Guide |

MU100010A

| | |
|--------|------------------------|
| B0692A | ESD box * ² |
|--------|------------------------|

*1: One of these power cord come with according to your country.

*2: Up to four SFP+/SFPs can be stored.

MU100090A

| | |
|--------|------------------------|
| J1705A | AUX Conversion Adaptor |
| J1706A | GPS Antenna |
| J1710A | BNC Cable (20cm) |

2.1.2 Optional Accessories

One or more of the following optional accessories may be delivered with the instrument (if included in the order):

| | |
|---------|--|
| B0691A | Hard case |
| B0691B | Hard case |
| B0720A | Rear Cover |
| B0729A | Screw 1U |
| B0730A | Screw 2U |
| B0731A | Screw 3U |
| B0732A | Screw Kit |
| B0733A | Hard Case |
| G0306B | Video Inspection Probe |
| G0324A | Battery Charger |
| G0325A | GPS receiver |
| G0382A | Autofocus Video Inspection Probe |
| J1569A | Car 12 Vdc adapter |
| J1667A | GPIB-USB Converter |
| W3933AE | MT1000A Transport Modules Operation Manual |
| W3736AE | MT1000A Network Master Pro/ MT1100A Network Master Flex Remote Scripting Operation Manual |

2.2 Mains Power Adapter

The Network Master can be powered from the supplied AC mains adapter.

CAUTION

Always use AC mains adapter delivered from Anritsu.

2.2.1 Connecting Mains Power Adapter

To connect the mains power adapter to the Network Master, follow the procedure below:

1. Insert the mains adapter's DC power plug into the socket connector marked '18V DC'. The DC input connector is located on the right-hand side of Network Master's connector panel.



When option 006 is installed, the area around DC input connector is marked in yellow. Connect G0385A High power DC adaptor.

When option 006 is not installed, connect G0309A DC adaptor.

2. Connect the AC plug of the mains adapter to the mains and switch on the mains wall outlet. The power button will flash fast on orange during booting. Then flashes slowly on orange when charging.

2.3 Rechargeable Battery

The Network Master is delivered with a 10.8 V Intelligent Li-Ion rechargeable and replaceable battery. The typical operation capacity (with a fully charged battery) will be approximately 4 hours.

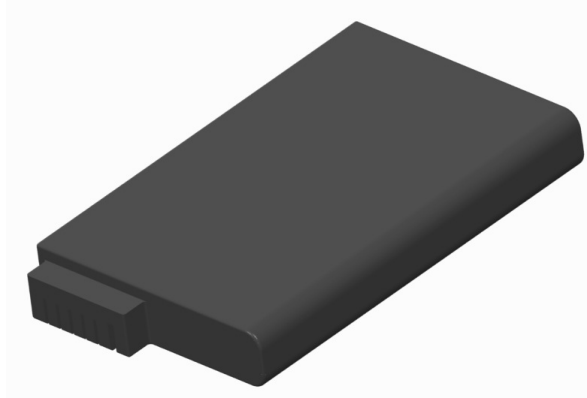

CAUTION

Use only original batteries delivered from Anritsu, to prevent the risk of instrument damage or personal injury.

Battery should only be charged at room temperature.

Initial charging

The battery will normally be partially or fully discharged on delivery. It is recommended to charge the battery immediately after delivery and unpacking. In Stand By Mode, the **ON/OFF** indicator will stop flashing when the battery is fully charged.



If the battery will not to be used for a long period of time, it is recommended that it contains at least 20% capacity. Charge the battery before storage, if necessary.

Temperature

When charging is in process, the temperature of the battery will increase. The intelligence of the battery will ensure that the charging takes place at the correct temperature.



If the battery temperature reaches 60°C or over while Network Master is in battery operation, Network Master shuts down automatically. In this case, leave the Network Master for approximately one hour to cool itself at room temperature (around 25°C) before using Network Master again.

2.3.1 Installing or Replacing Battery

To install or replace the battery in the Network Master, follow the procedure below:

1. Disconnect the mains power adapter if it is connected.
2. Switch the Network Master **OFF**.
3. Place the instrument on its back on a plain surface and turn the lock screw of the battery compartment to match the unlock mark.
4. Remove the lid of the battery compartment.
5. Pull out the battery from the compartment.



6. When installing the battery, note the direction of the battery terminals. With the instrument placed on its back - and the battery compartment in front of you - the terminals should be in the upper left corner.
7. Re-install the battery compartment door and tighten the lock screw.

2.3.2 Charging Battery in Fast Mode

Power is supplied from the external AC mains adapter - and the Network Master is switched **OFF** during the charging (Stand By Mode).

To charge the Network Master battery using the fast charge mode, follow the procedure below:

1. Switch the Network Master **OFF**.
2. Connect the mains adapter, as described in the "[Connecting Mains Power Adapter](#)" section.

Indication during charging

When the mains adapter has connected, the Power button will flash after approx. 30 seconds, indicating that charging is in progress. When the flashing stops, the charging is complete. If the battery is defective - the Power button will also light. Therefore, the best way to check the battery status is to switch on the Network Master and observe the battery information as described in the [Instrument toolbar](#) section.

2.3.3 Charging Battery in Normal Mode

Power is supplied from the external AC mains adapter - and the Network Master is switched **ON** during the charging.

A normal charging of the battery is taking place every time the instrument is in use and connected to the mains adapter.

The battery status can be checked in the instrument toolbar (expandable icon toolbar) on the right-hand side of the screen, or in the status line if the battery indicator is displayed there. See the "[Battery Status Information](#)" section below.

2.3.4 Battery Status Information

The battery icon is displayed in the status line at the bottom of the screen.

The following icons are used to indicate the current battery status:



The battery is fully charged. The Network Master is using the AC adapter as power source.



There is no battery in the Network Master (or the battery is malfunctioning). The Network Master is using the AC adapter as power source.



The Network Master is using the battery as power source. The AC adapter is not connected.



Battery charging is not doing because it is out of rechargeable temperature range. The Network Master is using the AC adapter as power source.



There is a delay of several seconds before the battery status is updated.

A more detailed battery status information is launched when touching the battery icon. The example in the figure below shows the status screen of a battery during charging.

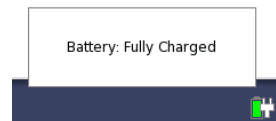

2.4 Optical Fibers

Open the protective cover of the measurement port, then connect the optical fiber under the test.

CAUTION

Never force the connector ferrule or insert it at an angle into the adapter. Optical fibers are susceptible to loss from microbends or other stress.

Connect the optical fiber cable to the port displayed on the screen. If the optical fiber cable is connected to a wrong port, you cannot obtain accurate measurement values.

1. Open the protective cover on the Measurement Port.
2. Clean the surfaces of the connector and fiber before connecting the fiber.
Refer to [Optical Connector/Optical Adapter Cleaning](#) for details.
3. Connect the fiber under test directly to the measurement port.

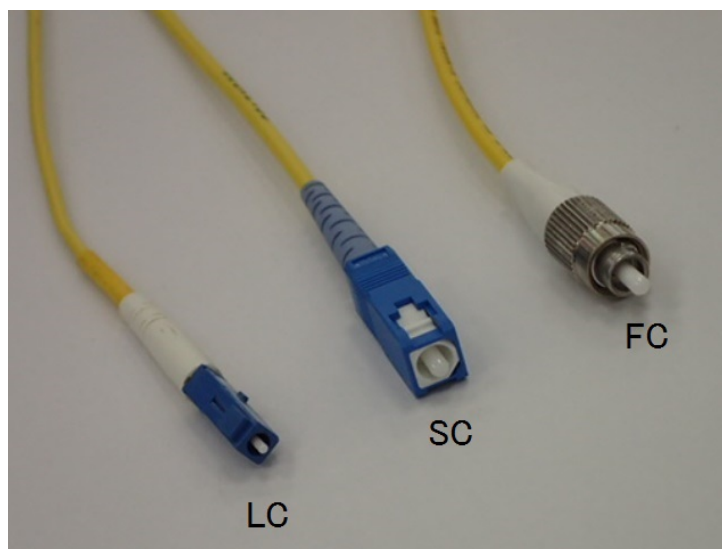

Commonly Used Optical Connectors

Connectors of OPM and VFL ports are Universal type. Be careful not to loosen the connector during measurement.

2.5 Support Stand and Carrying Strap

2.5.1 Support Stand

The Network Master is equipped with a support stand keeping the instrument at a convenient angle during the operation. To extract the stand: pull out the metal bar on rear of the instrument - it automatically stays in the correct position.

Be sure to open a support stand fully. Otherwise, the Network Master will be more likely to tip over. Moreover, the air flow on bottom panel will be insufficient.



2.5.2 Carrying Strap and Handle

The included carrying strap and handle can easily be mounted for your convenience when transporting and/or using the Network Master.

The carrying strap is equipped with hooks for easy installation.

WARNING

Use the Carrying Strap around your shoulder. Do not wrap the strap around your neck.



How to attach carrying strap and handle

To attach carrying strap (Z1747A) and handle (Z1748A) to MT1000A Network Master Pro, follow instructions below.

The procedure is same for OTDR modules.

1. Use screw driver and remove the battery lid from MT1000A.



2. Remove the battery pack.



3. Loosen four screws at each corner of MU100010A.



4. Separate MT1000A and MU100010A.
5. Attach the handle on either right or left side.



6. Detailed photos for upper and lower corner.

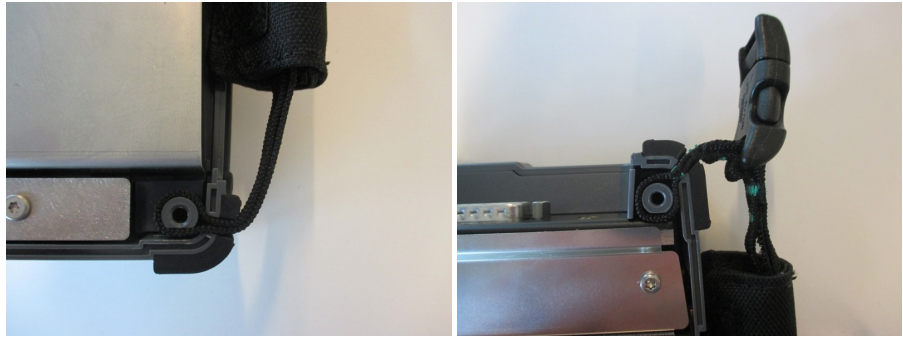

7. Remove the buckle cap from the handle and the carrying strap.

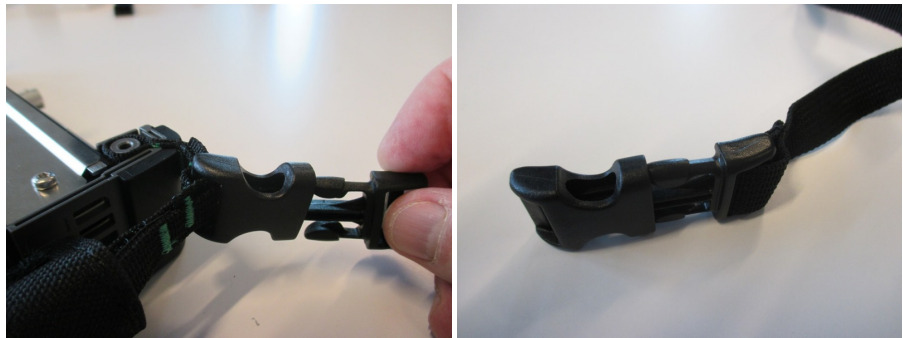

8. Mount the carrying strap on both upper corners.



9. Attach MT1000A and MU100010A , insert the battery pack and mount the battery lid with the reverse sequence at the beginning.



2.6 Modules Configuration

Following modules are available for MT1000A.

Transport Modules

- MU100010A 10G Multirate Module
- MU100011A 100G Multirate Module

OTDR Modules

- MU100020A OTDR Module 1310/1550nm SMF
- MU100021A OTDR Module 1310/1550/850/1300nm SMF/MMF
- MU100022A OTDR Module 1310/1550/1625nm SMF

CPRI RF Module



- MU100040A CPRI RF Module

GPS Module

- MU100090A High Performance GPS Disciplined Oscillator

MT1000A is able to mount up to three modules. Available module combinations are eleven kinds and shown in the table below.

Only one OTDR module can be mounted to the MT1000A.

| One module configuration | | | | | |
|---|-----------|-----------|-----------|---------|----------|
|  | Transport | OTDR* | CPRI RF* | | |
| | MT1000A | MT1000A | MT1000A | | |
| | | | | | |
| Two modules configuration | | | | | |
|  | Transport | Transport | Transport | OTDR* | CPRI RF* |
| | OTDR | GPS | CPRI RF | CPRI RF | OTDR |
| | MT1000A | MT1000A | MT1000A | MT1000A | MT1000A |
| | | | | | |
| Three modules configuration | | | | | |
|  | Transport | Transport | Transport | | |
| | OTDR | OTDR | CPRI RF | | |
| | GPS | CPRI RF | OTDR | | |
| | MT1000A | MT1000A | MT1000A | | |
| | | | | | |

*: When OTDR module or CPRI RF module is mounted last on the back, install the rear panel. B0728A Rear Panel Kit comes with different length screws.

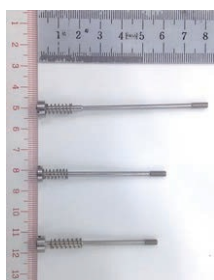

| Model | Name |
|--------|----------|
| B0731A | Screw 3U |
| B0730A | Screw 2U |
| B0729A | Screw 1U |

The modules configuration that uses an MU100011A 100G Multirate Module, MT1000A-006 high power supply is required for MT1000A even when measurement function of MU100011A is not used.

2.7 Attaching the Modules

An OTDR module is attached to MT1000A by combining with one of following.

- Rear panel
- MU100010A 10G Multirate module
- MU100011A 100G Multirate module

CAUTION

Replacing modules operation should be done on the table where antistatic measures are taken.

This section describes removing and to attaching MU100010A.

2.7.1 Replacing the MU100010A 10G Multirate modules

1. Switch the Network Master **OFF**.
2. Before the detaching operation, disconnect the AC adapter and remove the battery pack.
3. Place the instrument on its front on a plain surface.
4. Loosen the screws (shown by the yellow circle) on rear side of the MU100010A 10G Multirate module.



5. After loosening the four screws, lift up the 10G Multirate Module with holding both sides. If you cannot lift up, loosen the four screws again. You can see the panel as below.



To detach the OTDR module, do the same operation as detaching the Power Supply Module.

2.7.2 Attaching OTDR module with 10G Multirate module

1. Place the instrument on its front on a plain surface.
2. Attach OTDR module to MT1000A. Place OTDR module on MT1000A as to connect following pairs: 1 - 4, 2 - 5, 3 - 6.
Be careful not to bump the guide pins (2, 3, 5 and 6) to the connectors (1 and 4).



3. Remove four screws of 10G Multirate module and replace to screws 2U in B0728A Rear Panel Kit.



4. Attach 10G Multirate module to OTDR module. Place 10G Multirate module on the OTDR modules as to connect following pairs: 7 - 10, 8 - 11, 9 - 12.
Be careful not to bump the guide pins (8, 9, 11 and 12) to the connectors (7 and 10).



5. Tighten the four screws.



After the module attachment has finished, the external appearance will be as below.



6. After attaching the modules, connect the AC cable or install the battery packs.

2.7.3 Attaching OTDR module without 10G Multirate module

1. Place the instrument on its front on a plain surface.
2. Attach OTDR module to MT1000A. Place OTDR module on MT1000A as to connect following pairs: 1 - 4, 2 - 5, 3 - 6.
Be careful not to bump the guide pins (2, 3, 5 and 6) to the connectors (1 and 4).



3. Insert screws 1U in B0728A Rear Panel Kit to four corners of the rear panel.



4. Place the rear panel on the OTDR module.



5. Tighten the four screws.



After the module attachment has finished, the external appearance will be as below.



6. After attaching the modules, connect the AC cable or install the battery packs.

3 Human-Machine-Interface

Human-Machine-Interface (HMI) covers the relation between the user and the instrument - in other words: the information you get from the instrument combined with the action you add to the instrument.

The informative part is the TFT display, and the part susceptible to influence is the touch-active layer of the screen. Connections made to the input and output connectors are included in the HMI as well.

3.1 Touch Screen Display

The 9 inch active TFT display with WVGA resolution (800x480 pixels) is used for setups and for presentation of results (that is, for all interaction with the instrument). As the display includes touch screen functionality, it is possible to navigate and operate directly from it.

The touch screen display is constructed to be operated by the tip of your finger or by the included *Stylus* (Anritsu part No. Z1746A). The touch screen surface is made of delicate material and is easily scratched or damaged if handled incorrectly.

 **CAUTION**

Never expose the touch screen to excessive pressure as this may damage its functionality.

Never use sharp objects (e.g. pens, paper clips etc.) to operate the touch screen, as this may damage the surface.

If the touch screen breaks and liquid leaks out, DO NOT touch or ingest the liquid and avoid getting it in your eyes. The liquid may be poisonous.

Only use a soft cloth moisturized with a mild detergent to clean the surface of the touch screen. Be sure to power off and disconnect main power adapter.







3.2 Key Operation

The only physical operator key (the Power button) is described in this section.

3.2.1 Power Button



The Power button on the front panel of the instrument is used to switch power ON and OFF. In addition, the menu used for power-off also contains a few extra options (e.g. to lock the screen).

-  Gray: Power off
-  Orange flashing (fast): Booting in case of AC operation
-  Green flashing: Booting in case of the battery operation
-  Orange flashing (slow): Charging
-  Orange: Stand by
-  Green: Operating

Switching power ON

AC Operation

Connect the mains power adapter to the Network Master. The Network Master flashes the power button in orange during booting. The power button lights in orange after booting.

To start your test, press the power button. The power button lights in green. After a model name is displayed, the Network Master enters Operating status and shows the Application Selector.

Battery Operation

Press the power button. The Network Master shows a model name and flashes the power button in green during booting.

Then, the Network Master enters Operating status and shows the Application Selector.

Switching power OFF

When you press the Power button, a pop-up menu containing **Shut Down** will appear.

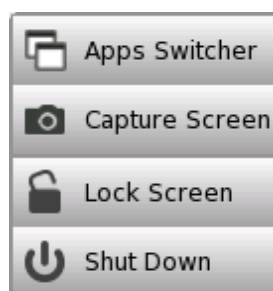

Touch **Shut Down** and then confirm by touching **Yes** in a dialog box.

AC Operation

After you shut the Network Master down, the Network Master goes back to Stand by or Charging state.

The Network Master stays Stand by or Charging state until you disconnect the mains power adapter.

Battery Operation

After you shut the Network Master down, the power goes off.

Forcing power OFF

If it is not possible to power down the Network Master using the power button menu, the following procedure can be used to make an emergency power down.

1. Disconnect AC adapter if it is connected.
2. Hold the Power button depressed for a couple of seconds.



It is not recommended to force a power-off except in emergencies.

Additional options in power button menu

Apps Switcher

Shows all currently activated applications and allows you to switch among them.

Capture Screen

Saves a screen shot image in .PNG format. The image file will be saved in 'Internal/screens' folder or an attached USB memory stick.

Lock Screen

Locks or unlocks the screen.

3.3 Head Set

You can use the commercially available head set (3.5 ϕ CTIA).



OTDR module do not have applications which use the head set.

The volume is controlled from the General setup in 'Instrument Toolbar'.

The head set is connected to the socket marked with a head set symbol on the connector panel of the Network Master.



3.4 Connector Panel

All connections (both for *test interfaces* and for *service interfaces*) are placed on the connector panel of the Network Master.

The figure below shows the connector panel of the mainframe and MU100021A.

3.4.1 Test Interfaces

The connector panel contains the following port connectors to be used for the tests:

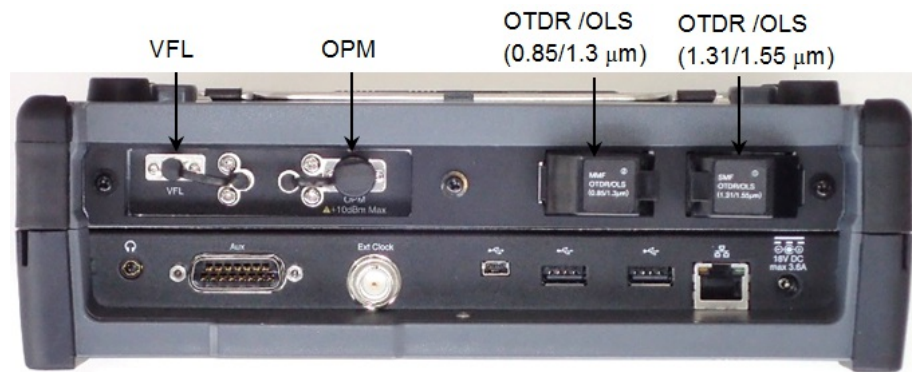

| | |
|----------------------------------|--|
| VFL | Optical output of Visible Fault Locator (Optional) |
| OPM | Optical power meter input 1.25 mm \varnothing or 2.5 mm \varnothing ferrule can be connected by using Universal connectors provided as standard accessory.  Universal connectors are screw type. To remove it, turn counterclockwise. |
| OTDR/OLS (0.85/1.31 μ m) | Connector used for testing multi-mode fiber. Outputs the optical pulse of 850 nm or 1300 nm wavelength. Only MU100021A has this connector. UPC connector is used to this connector even if Option 011 is installed. |
| OTDR/OLS (1.31/1.55 μ m)* | Connector used for testing single mode fiber. Outputs the optical pulse of 1310 nm or 1550 nm wavelength. For MU100022A, outputs the optical pulse of 1310 nm, 1550 nm or 1625 nm wavelength. The connector polish depends on the option: Option 010: UPC Connector Option 011: APC Connector |

*: For MU100022A, (1.31/1.55/1.625 μ m)

3.4.2 Service Interfaces

All connections concerning the service interfaces are also located on the connector panel:

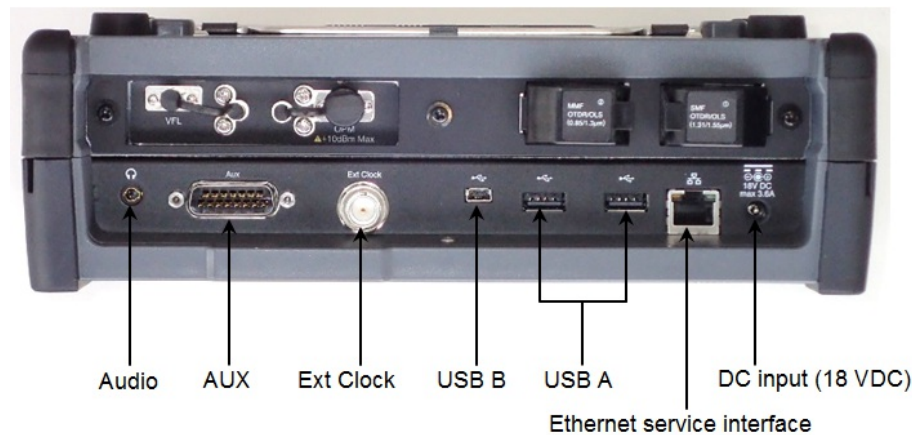

| | |
|----------------------------|--|
| Audio | The audio connector is used for connecting to an optional head set. |
| AUX | The AUX connector is used for optional G0325A GPS Receiver. |
| Ext Clock Input | The Ext Clock Input connector is used for reference clock input. |
| USB B | The three USB connectors (two connectors type A and one connector type B mini) can, for example, be used for connection with USB memory stick. This is convenient for the exchanging of information to other instrument. |
| USB A | |
| Ethernet service interface | The Ethernet connector is used for connecting the Network Master to a Local Area Network, e.g. to remotely operate the instrument from a Personal Computer (hereafter, "PC"). |
| DC input (18 VDC) | The DC power connector is used for connection of 18 V DC power delivered from the AC Adapter. |

3.4.3 Optical Connector/Optical Adapter Cleaning

⚠ WARNING

Check that no light is being emitted when cleaning and checking the ferrule end surface.

⚠ CAUTION

The Network Master may not satisfy performance when used with dirt or dust adhering to the ferrule end surface. In addition, the connected fiber and/or the Network Master ferrule end surface may be burned if high output light is emitted in this state. Fully clean the fiber to be connected and the Network Master ferrule end surface before measurement.

Cleaning the Network Master Connector Ferrule End Surface

Use an approved adapter cleaner to clean the ferrule inside of the Network Master measurement port(s). The ferrule should be cleaned periodically. Although the following procedures use the FC connector and adapter as an example, use the same methods when cleaning other connector and adapter types.

1. Remove the currently connected adapter by raising the adapter lever (you will hear a "click" when the latch disengages) and then gently pull the adapter straight towards you.

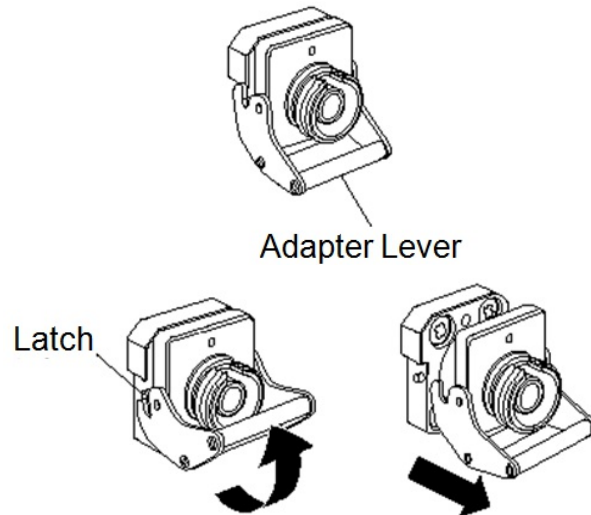

2. Saturate an adapter cleaner with isopropyl alcohol and then use it to clean the end surface and sides of the ferrule.

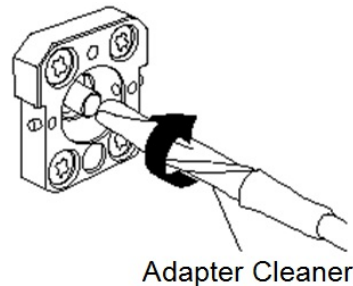

3. Press the tip of a new (dry) adapter cleaner into the ferrule end surface and then wipe in one direction 2 or 3 times to dry the surface.

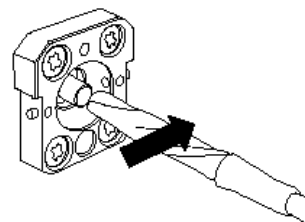

4. Clean the connector adapter before reattaching it. See the following procedure "To clean an Optical Adapter:" for details.
5. Attach the adapter in the reverse order described in step 1. Be careful not to scratch the ferrule end surface.

Cleaning the Optical Adapter

Use an approved adapter cleaner to clean the optical fiber cable optical adapter.

1. Remove the Optical adapter.
2. Saturate an adapter cleaner with isopropyl alcohol and then insert it into the split sleeve of the adapter. Rotate the adapter cleaner in one direction while moving it back and forth.

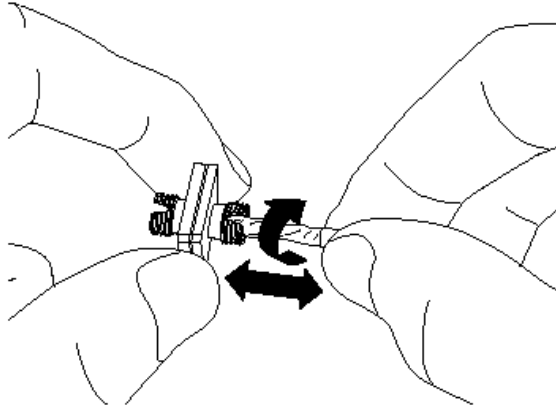

Check the ferrule diameter and use a cleaner only for the ϕ 1.25 mm or ϕ 2.5 mm adapter.

Cleaning the Optical Fiber Cable Ferrule End Surface

It is advised that you clean the ferrule end surface of the fiber to be tested with an approved ferrule cleaner prior to making any connections.

1. Pull the ferrule cleaner lever to expose the cleaning surface.

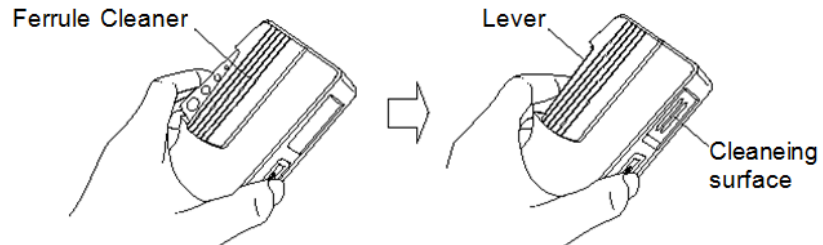

2. Hold the lever in the opened position, press the optical connector ferrule end into the cleaning surface, and then rub in one direction as shown in the following figure.

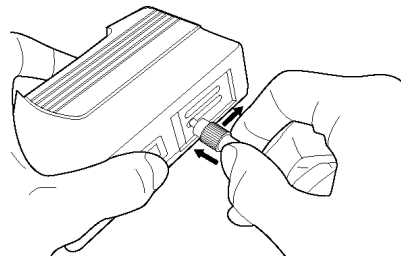

General Notes on Cleaning

- Do not clean with a used ferrule cleaner.
- Do not finish cleaning with a swab as the swab fibers may adhere.
- Cap the cleaned connector.

3.5 Command-Based Remote Control

For OTDR modules, the remote control is available in software version 6.00 or later.

- The Network Master remote control communication functions support the built-in Ethernet service interface.
- Software specifications are in conformity with the IEEE488.2 standard and SCPI version 1999 (Standard Commands for Programmable Instruments).

All commands are described in a separate document:

- MT1000A Network Master Pro OTDR Modules Remote Scripting Operation Manual (M-W3859AE).



This icon on Status bar indicates whether the Network Master is controlled by the command-based scripts or not. If touching this icon, buttons appear.

Touching the **Turn Off** button will disconnect the SCPI connection. Use this button if disconnecting the Ethernet cable.

Touching the **Enable Local Control** button will allow the panel operation with keeping SCPI connection. This function is useful for debugging the control software.

3.6 File Access via USB Interface

You can access the mass storage of the Network Master by connecting the USB cable.

This function is useful to copy the files to PC, or confirm the test results.

1. Close all applications by touching **Close** icon on the Application Tool Bar.
2. Connect the USB cable between PC and USB type B connector of the Service Interface.
3. If PC has detected the Network Master, copy files or folders to PC using PC software (Explorer of Windows etc.).



If applications are running on the Network Master, you cannot access the mass storage.

3.7 File Access via Ethernet Interface

3.7.1 Accessing files in Network Master from the PC

The mass storage of the Network Master can be shared with your PC via Ethernet interface.

1. Connect an Ethernet network cable to the LAN connector on your Network Master and link this to a Local Area Network.
2. Assign an IP address to the Network Master. This is done in the *Ethernet* available in the [Network](#) screen as described in the *Graphical User Interface* chapter.
3. Select **Share File System** in the [File Sharing](#) settings.
4. Start *Explorer* on your PC.
5. Enter the IP address of Network Master into the address bar.
For example, enter like \\192.168.10.4\). The shared folder appears.

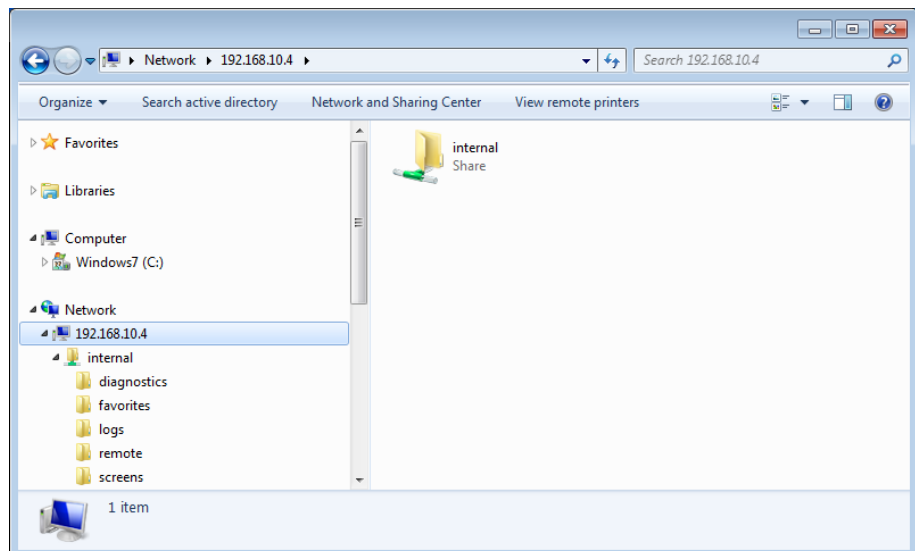

*If applications are running on the Network Master, you cannot access the mass storage.
The folders and files in the mass storage are set to read-only.*

3.7.2 Mounting the Shared Folder of Networked PC to the Network Master

Network Master can mount the shared folder of the networked PC.

1. Create the folder in the PC.
2. Right-click on the folder and click Property.
3. Click Sharing tab, and click **Share** button to set shared.

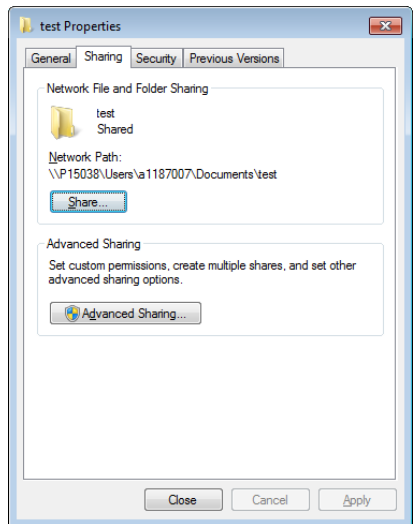

4. Connect an Ethernet network cable to the LAN connector on your Network Master and link this to a Local Area Network.
5. Assign an IP address to the Network Master. This is done in the *Ethernet* available in the [Network](#) screen as described in the *Graphical User Interface* chapter.
6. Select **Mount Remote Folder** in the [File Sharing](#) settings.
7. Enter the IP address of networked PC, User name, Folder name etc. Note that enter User name of User Account of the PC.
8. Touch **Apply**. If the remote folder has mounted, "CONNECTED" will be shown. Then close dialog box.
9. Touch File Manager icon in Instruments Toolbar. The PC shared folder will be mounted to the instrument Internal\remote folder.

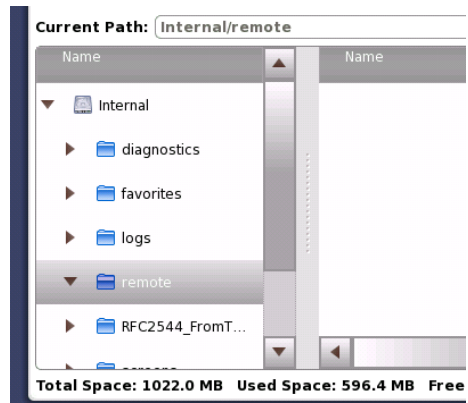

3.8 GPS Receiver

3.8.1 G0325A GPS Receiver

G0325A GPS Receiver contains GPS antenna and GPS receiver and is used by connecting to AUX connector of MT1000A. The synchronization accuracy against UTC is $\pm 1 \mu\text{s}$ or less.



OTDR modules do not have applications which use a GPS Receiver.



Connect The 15 pin D-sub connector to the AUX connector on the connector panel.

Activating the GPS receiver

The GPS receiver is activated automatically if it has connected to Network Master.

3.8.2 Operating GPS Receiver

GPS Icon

An icon in the status bar will indicate the current GPS status. One of the following icons will be shown:



The GPS is receiving signal from a sufficient number of satellites.



GPS receiver is not connected.

Touching the icon will display an information pop-up dialog box.



The pop-up dialog box shows the current GPS status, and, for purely informational purposes, the number of satellites used for position fix, and the current geolocation of the GPS receiver, in degrees and decimal minutes format.

When MU100090A is attached, buttons appear in the pop-up dialog box. For MU100090A, refer to *W3682AE MT1000A/MU100010A Network Master Pro Operation Manual*.

4 Graphical User Interface

This chapter provides a general introduction to the graphical user interface (GUI). The descriptions of the screens, sub-screens and major dialog boxes related to specific technologies and applications are placed in separate chapters.

4.1 General Handling of the GUI

The Network Master is equipped with a touch screen display, except for the key to switch the instrument on/off. The operating principle of the graphical user interface (GUI) presented on the touch screen display is that it guides you through all setup steps required for running a specific test and then finally presents you with the test results. You can also navigate back and forth between setup steps and result presentation to re-run a test with new parameter settings if required.

4.1.1 GUI Concept

The GUI can be split up into two functional spaces or levels: the *desktop* and the *workspace*.

- The *desktop* is the entry level which appears after the booting. It consists of the *application selector*, which allows you to start a new application, and the *result file browser*, which allows you to access previously created and stored test results.
- The *workspace* is where you work with a specific application (i.e. set up and run a test and inspect the test results). Your selection on the desktop creates the workspace and loads relevant data into it.

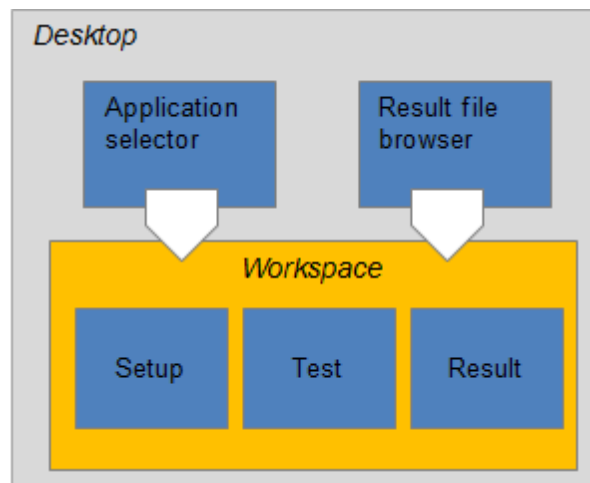

Application selector

The *application selector* loads a new application into the workspace. A new application can be either one of the standard applications provided with the instrument or a previously saved application with partial or full configuration of interface/test setup parameters.

Result file browser

The *result file browser* loads the results and configuration of a previous test into the workspace. This allows you to generate reports from the results and/or to rerun the test (either using the original configuration or with various configuration modifications).



A specific set of resources (i.e. ports) are assigned to a workspace when it is created. More than one workspace can therefore exist at the same time, each assigned to different resources.

4.1.2 Navigating in the GUI

As shown in the previous figure, you can navigate from the application selector to a specific application in the *workspace* vertically. You can navigate between the application selector and the result file browser in the *desktop* horizontally. In this way, you can switch screens in both horizontal and vertical navigation.

Horizontal navigation at desktop level

You can switch between the application selector and the result file browser by touching the tab displayed in the bottom right-hand corner and the bottom left-hand corner.

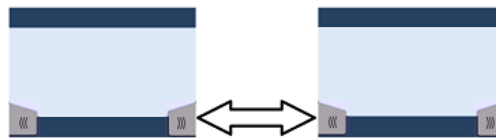

Horizontal navigation within a workspace



In the workspace you can step through the setup by touching the navigation tabs displayed in the bottom corners of the screen. The right-hand tab brings you to the next step in the setup, while the left-hand tab allows you to take a step backwards.

Alternatively, you can use the *screen indicator* at the bottom of the screen to switch between measurement setup, test setup and test result.



It is also possible to loop back directly to the setup from the test result screen if you need to rerun the test with different settings.



To get from the Test Setup to the Test Result screen during a new test, you must run the test. This is done by touching the  or  in the Application toolbar, which is the expandable toolbar shown on the right-hand side of the screen. Please refer to the separate [Toolbars](#) section for information about the toolbars.

Vertical navigation between desktop and workspace

When an application is currently running, the application selector screen will contain a tab at the bottom which allows you to go directly to the screen last displayed in the application's workspace. Similarly, the result file browser screen will contain a tab at the bottom which brings you to the test result screen of the running application.

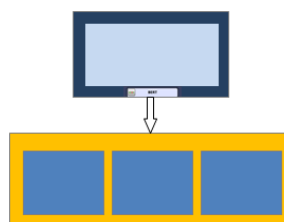

From a setup screen you can return to the application selector using the tab at the top of the screen. Test result screens contain a tab at the top which returns you to the result file browser.

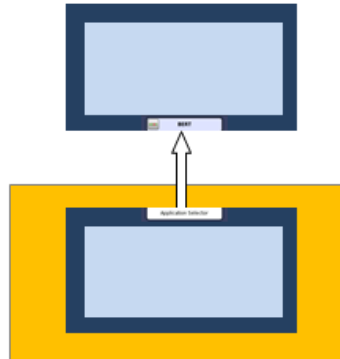

4.1.3 Layout of the GUI Screens



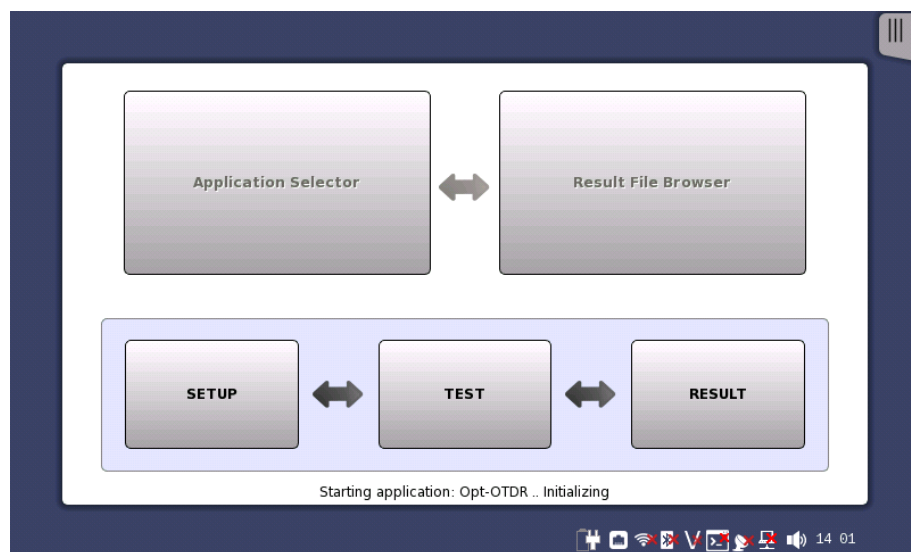







Startup Splash Screen The Network Master starts up with a splash screen that shows the GUI concept of desktop/workspace and the various screen types. It indicates both *application selector* and *result file browser* as entry points.



Status icons

There are status icons of the battery and the network connections at bottom of the screen. This blue area at bottom of screen is the "status bar".

When the network connection is unusable, the red cross (✖) appears on the icon.

-  Battery status
Refer to "[Battery Status Information](#)".
-  Link status of Ethernet service interface
-  WLAN (when the option is installed.)
-  Bluetooth (when the option is installed.)
-  VNC (Virtual Network Computing)
-  Controlled by the remote command
-  Connection status of GPS receiver
-  External PC status
-  Speaker On/Off status
-  Warning light blinking when the optical output switch is turned on.

4.1.3.1 Starting the Application

Application Selector The **Application Selector** screen is the main entry point after startup of the Network Master. From here you can choose which application/test to run: either one of the standard applications or a previously saved pre-configured application.

Applications

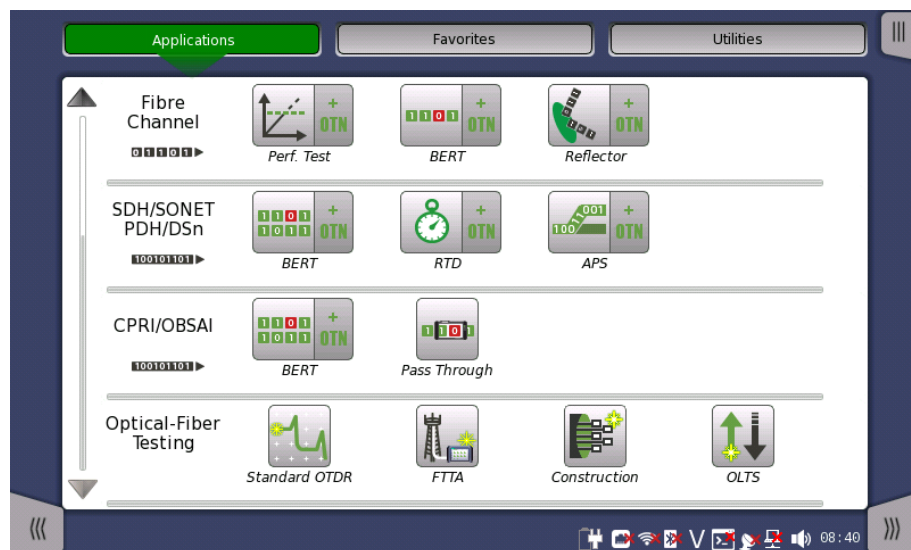

Aside from the application buttons, the application selector screen also contains a tab for showing/hiding the [Instrument toolbar](#) and a navigation tab to the [Result File Browser screen](#).

Favorites

A Favorite application is basically an application with an associated set of port resources and specific settings. When launching a Favorite application, the associated port resources are automatically allocated and the associated settings are subsequently loaded.

Favorites require a specific number of resources to run corresponding to the number of resources used when the Favorite was first created. If the resources of the Favorite are not available, user is prompted to select alternative port(s).

Touching **Favorites** button displays the screen below.

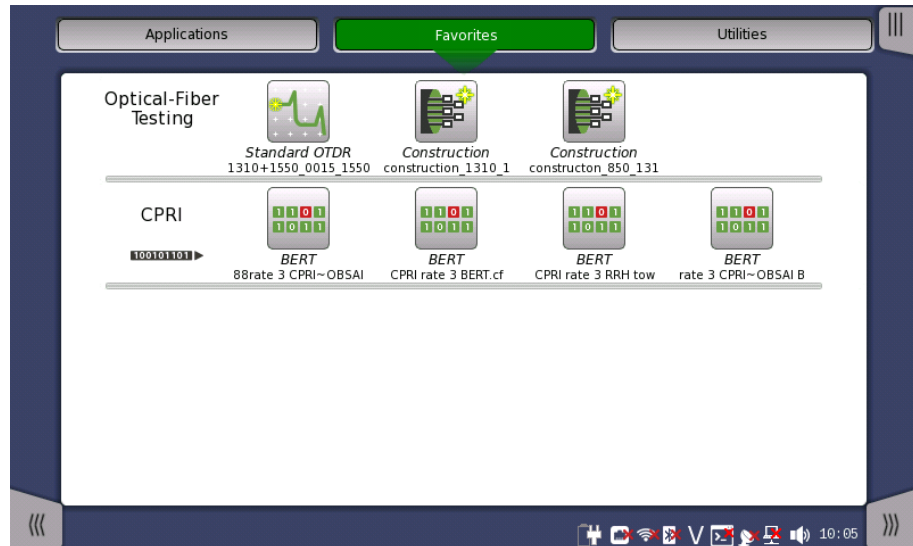

Creating favorites

1. Go to the workspace of the application you want to save as favorite.
 - o Touch the **Applications** button.
 - o Touch Standard OTDR icon, FTFA icon, or Construction icon. OLTS application cannot be registered to Favorites.
2. Touch the Application toolbar tab.
3. Touch the **Save** icon.
4. Touch the **File name** field.
5. Enter the file name using the dialog box.
6. Select **Add to Favorites** in the Save dialog box.

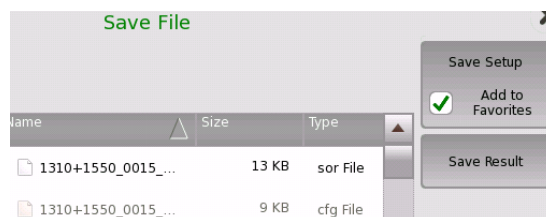

7. Touch the **Save settings** button.

On the Favorites screen a new favorite is now created containing the current application resources and settings.

Deleting favorites

1. Touch and hold an icon in Favorites screen until a pop-up menu appears.
2. Touch **Delete Favorite**.
3. Touch **Delete** if the confirmation dialog box appears.

Renaming favorites

1. Touch and hold an icon in Favorites screen until a pop-up menu appears.
2. Touch **Rename Favorite**.
3. Input a new name on the opening dialog box.

Importing favorites

Settings files (.cfg) can be registered to Favorites by using the [File Manager](#).

1. Open File Manager from the Instrument Tool bar.
2. Select to the .cfg file to import as favorite.
3. Touch the "Add to Favorites" button (♥+).



Favorites cannot have the same name. If conflicts occur, rename the .cfg file or the existing favorite before copying.

Utilities

Applications to view test results or a fiber edge surface are provided in Utilities application.

Touching **Utilities** button displays the screen below.



Scenario

- **Scenario Mgr.:** - manages the scenario file which runs applications automatically. Parameters in the file can be edited.
- If the scenario files are loaded, the icons will appear in Scenario row.







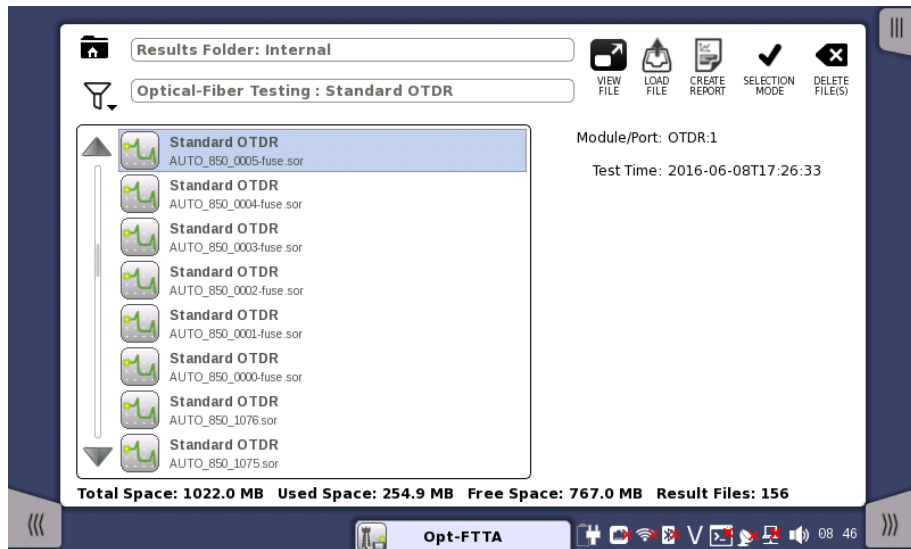

Utility

- **GPS:** - logs data from GPS receiver and shows the position of the satellites.
- **PDF Viewer:** - to view PDF files created by [Report](#).
- **VIP:** - to view a fiber edge surface with the Video Inspection Probe.
- **Wireshark:** - to view capture files (pcap) saved by **Frame Capture** from Ethernet applications.

Result File Browser

The **Result File Browser** screen is the other entry point after startup of the Network Master. From here you can access the results of previous tests to view the statistics directly, to generate PDF reports or to do both. Refer to "[Accessing Previous Tests and Test Results](#)".



-  Browses the folder.
-  Sets the filter of files.
-  Loads the result and starts the application with view mode.
-  Loads the result.
-  Creating the report from the result.
-  Selects single file.
-  Selects multiple files.
-  Deletes the selected file(s).

In addition to the buttons for accessing and handling test results, the result file browser also contains a tab for showing/hiding the [Instrument toolbar](#) and a navigation tab to the [Application Selector screen](#).

4.1.3.2 Switching the Applications

Applications Switcher If running other applications in [View mode](#), you can switch the application display by Application Switcher. There are three ways to display Application Switcher:

- In the desktop level, if two or more applications are running, touch and hold the workspace navigation button in the bottom center of the screen.
- In the workspace, touch the application in the left side of status bar.



- From the [Power Button menu](#).

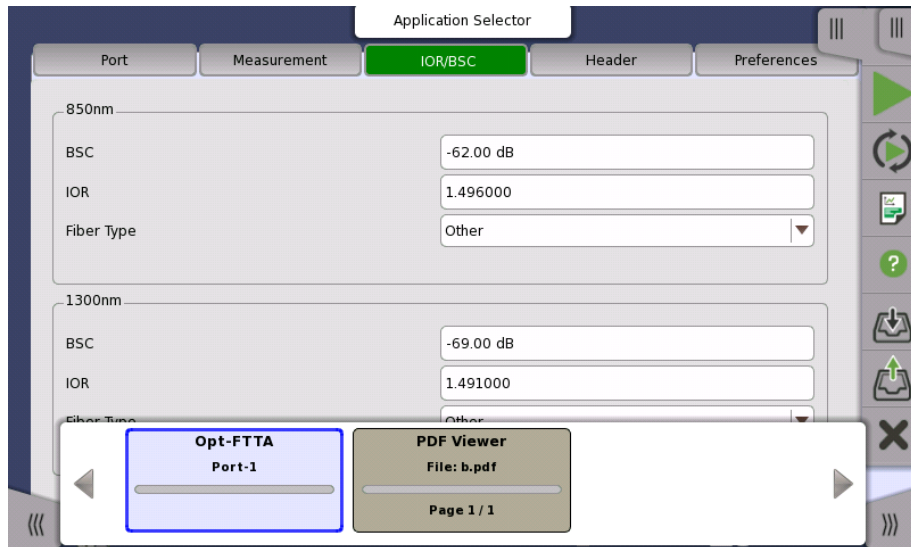

The running applications appear in the Applications Switcher. Touching the button switches the application on the screen.

4.1.3.3 Operating the Application

Setup screen

The **Setup** screen is the first screen in the workspace. It may contain one or more setup pages, with a row of buttons at the top of the screen allowing you to switch between the pages.

It consists of several "areas":

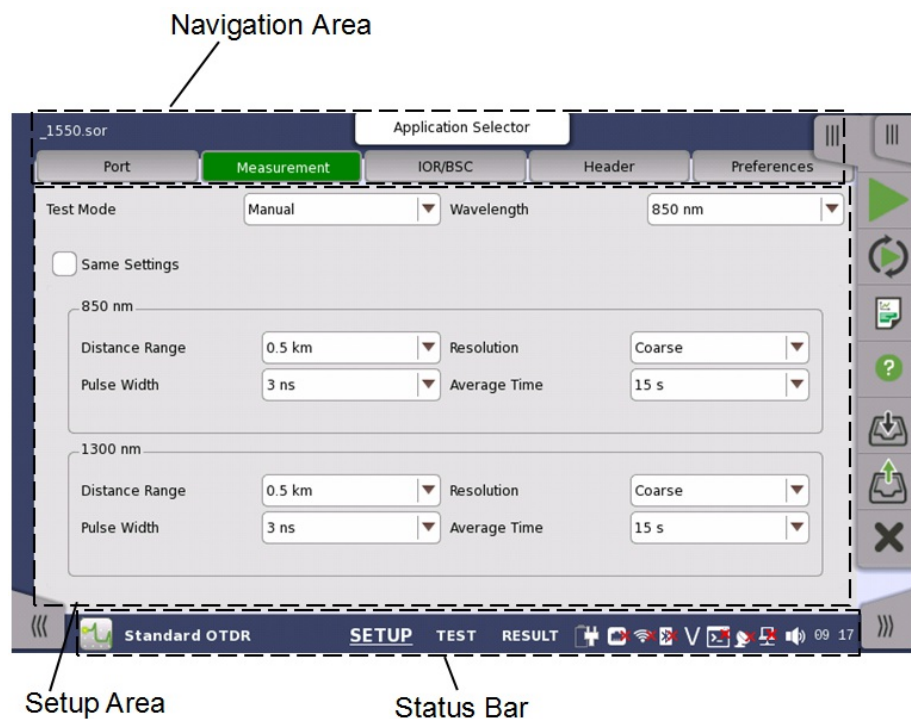

- The *navigation area* at the top of the screen contains a number of buttons switching the contents in setting area.
- The *setup area* (the main area of the screen) is where the parameters for setting up the measurement conditions are displayed. The contents of the area changes depending on what is currently selected in the navigation area.

The **Setup** screen also contains the [Application toolbar](#) and the navigation tabs for horizontal and vertical navigation.

Test screen

The **Test Setup** screen is the second screen in the workspace. It may contain one or more setup pages, with a row of navigation buttons at the top of the screen allowing you to switch between the pages (when relevant).

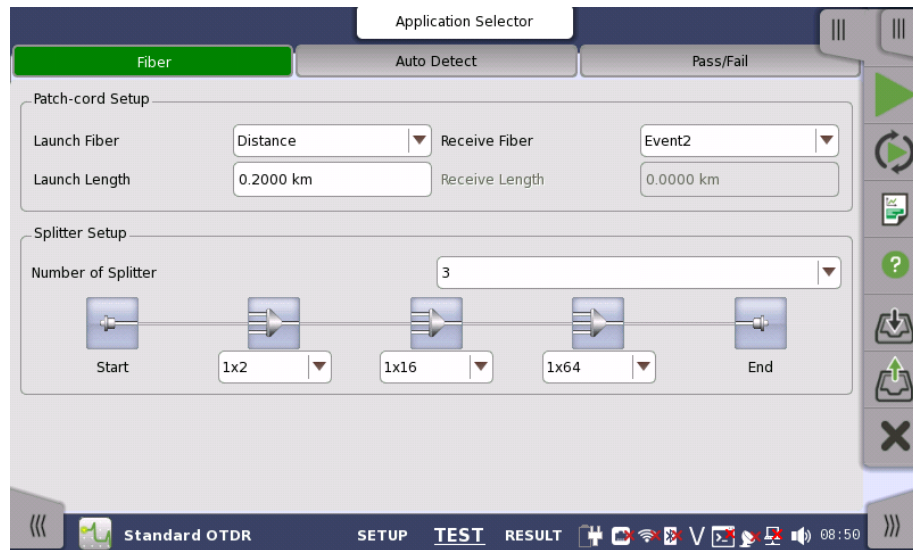

In addition to the various parameters, the **Test** screen also contains the [Application toolbar](#) and the navigation tabs for horizontal and vertical navigation.

Test Results screen

The **Test Results** screen is the last screen in the workspace. It generally contains several pages, reflecting the test results. Navigation buttons at the top of the screen will allow you to switch between the pages (when relevant).

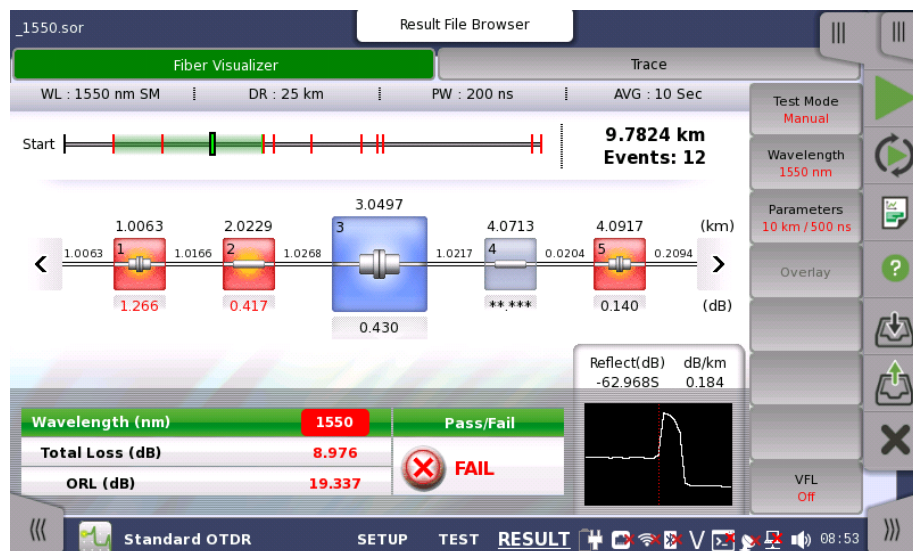

In addition to the results, whose presentation varies from application to application, the **Test results** screen also contains soft keys in right-hand. To save results to a file, touch  on the [Application toolbar](#).

4.1.4 Keypads for Entering Text in Fields

Alphanumerical or purely numerical keypads are used to enter text in fields. By touching the field you launch the related keypad. The layout (i.e. type) of a specific keypad will depend on which type of text is required/valid for the field.

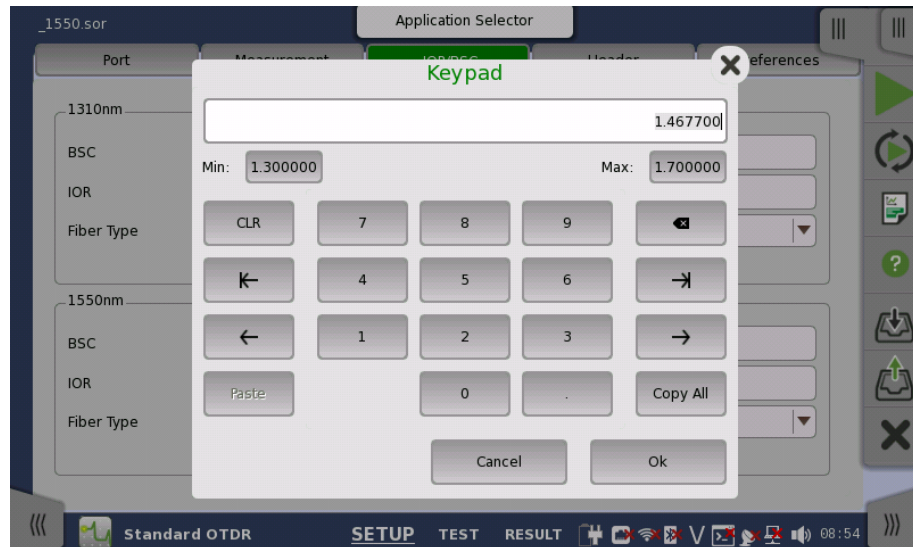

In general, a keypad consists of the character/number keys, a display field showing the current text/number entry, various editing-related keys. For number entries, the minimum and maximum values allowed are also shown. When you launch a keypad from a field, the current field value is shown in the keypad's display field.

Touch **Ok** to accept the new entry and close the keypad.

To close the keypad without accepting the change, touch **Cancel** or touch the "X" symbol in the upper right-hand corner of the keypad.

4.2 Toolbars

Two toolbars are available on the right-hand side of the screen: the desktop toolbar (called the *Instrument toolbar*) and the expandable workspace toolbar (called the *Application toolbar*).

- The [Instrument toolbar](#) contains general system functions and information (e.g. Instrument configuration, Battery time etc.). It is available directly on the screens related to the desktop, but can also be accessed on the workspace-related screens as a "sub-toolbar" inside the application toolbar.
- The [Application toolbar](#) contains application-related functions and information (e.g. Start/Stop test, File operation etc.). It is available on the screens related to a specific application (i.e. all workspace-related screens), with the *Instrument toolbar* as a sub-toolbar.

4.2.1 Instrument Toolbar

The *Instrument toolbar* is shown in the figure below. When the toolbar is hidden, it is represented by its icon tab in the top right-hand corner of the screen.

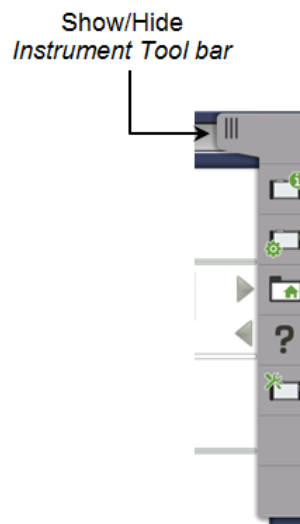

The *Instrument toolbar* contains the following functions/status:

- [Instrument information](#)
- Configuration([General](#), [Network](#))
- [File Manager](#)
- [Help](#)
- [Resource monitoring](#)

Instrument information



The *Information* icon launches the **System Information** screen. Touch the **Update About Info** button to generate the instrument information.

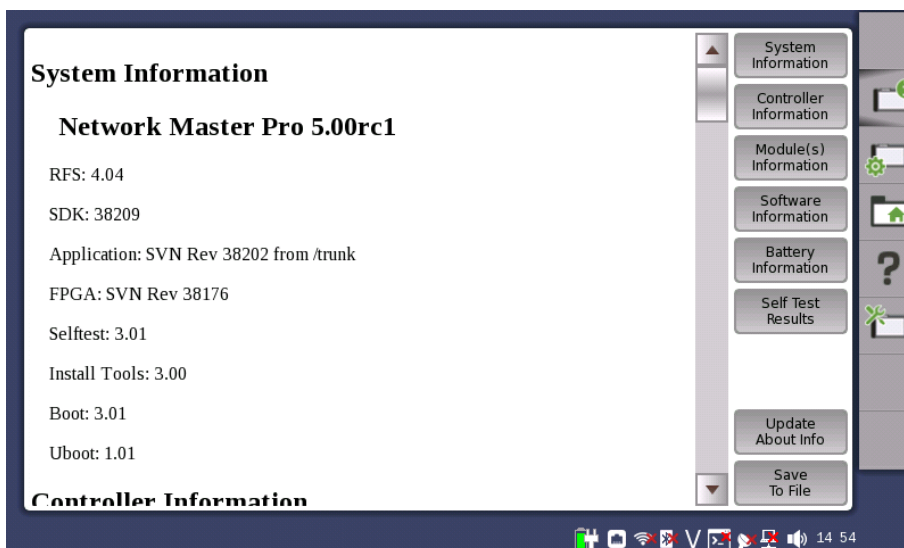

The following information is presented on the screen:

- System Information
- Controller Information
- Module(s) Information
- Software Information
- Battery Information
- Self Test Results

To save the instrument information in an HTML file, touch the **Save To File** button. This launches another dialog box, where you can specify file name and location. For the icons, refer to "[File Manager](#)".

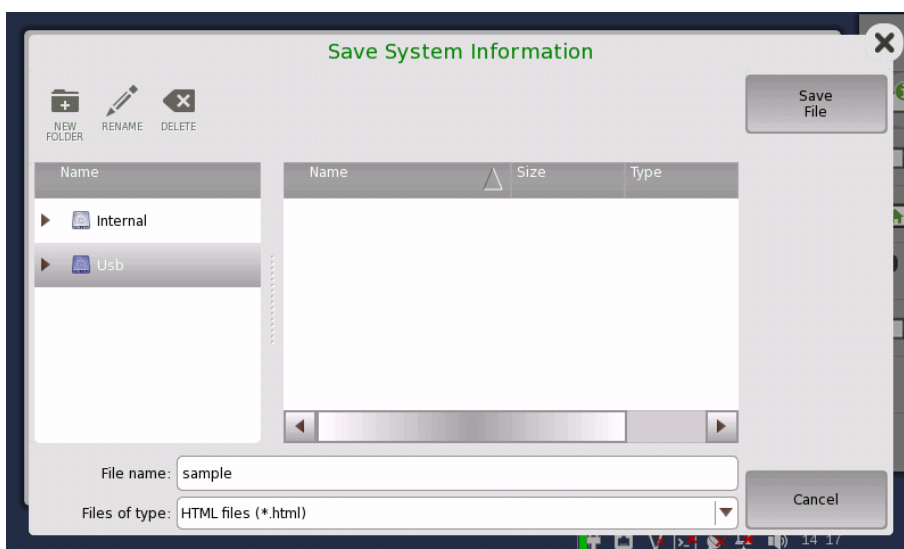

When there are "NG"s in the self test results, try to reboot Network Master. If "NG"s remain in the self test results, contact an Anritsu Service and Sales office.

Configuration



The *Configuration* icon launches the *Global Configuration* screen. From this screen, it is possible to configure both the general instrument settings (such as date/time, password etc.) and various network settings.

General

The **General** screen contains the following configuration options:

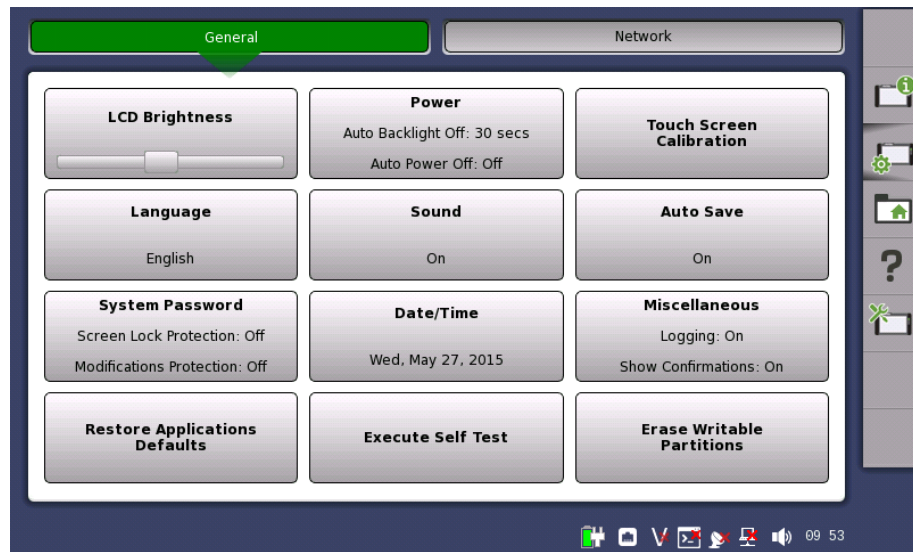

LCD Brightness

Allows you to change the screen brightness by using the slide bar.

Power

Allows you to specify auto backlight duration and auto power-off time.



*These settings are applied for the battery operation only.
When Wireshark application is running, **Auto Backlight Off** does not work.*

Touch Screen Calibration

Allows you to calibrate the touch screen. Touch **OK** in the dialog box to start the calibration.

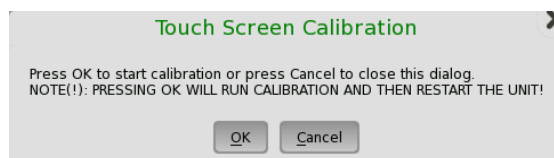

*Save the measurement results or settings before the touch screen calibration. Network Master reboots after the touch screen calibration. The measurement data which is not saved will be lost.
When operating with the battery, Network Master does not reboot.*

Language

Allows you to select language for the screens, and the keypad layout.

Sound

Allows you to specify speaker and headphones on/off. Change the volume by using the slide bar.

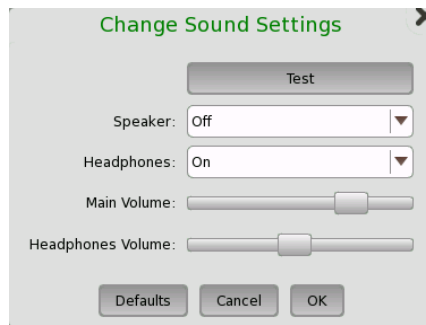

This icon indicates that the speaker is On.



This icon indicates that the speaker is Off.

Auto Save

Allows you to specify saving method of the measurement results.

- **Prompt:** Confirms saving results or not after a test.
- **On:** Saves results to the file automatically without notification every time a test ends.
- **None:** Does not save results. The results data are discarded if you do not save the data manually.

System Password

Allows you to enable/disable password protection and to specify a new password. When the password protection is enabled, starting applications and editing applications are protected.

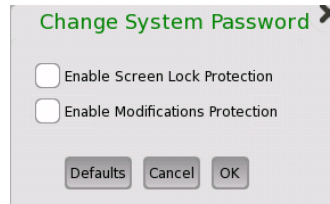

To change/set the password, select the one or more check boxes and then touch the **OK** button. A numeric keypad is displayed.

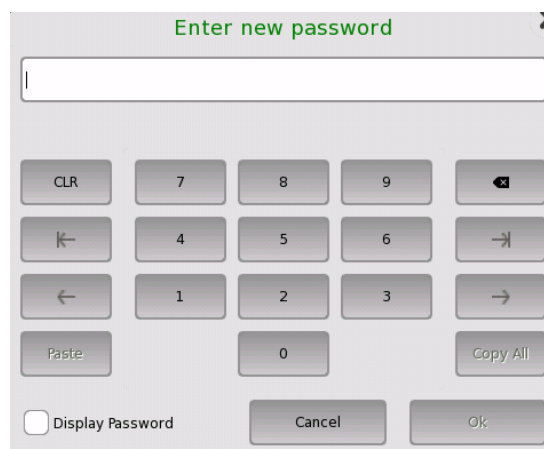

To see the numbers as you type them on the keypad, select the **Display Password** check box.



The password is set to 0614 as factory default.

Date/Time

Allows you to change the system date and time. Select a part in **New Time** or **New Date** field and touch the up/down button.

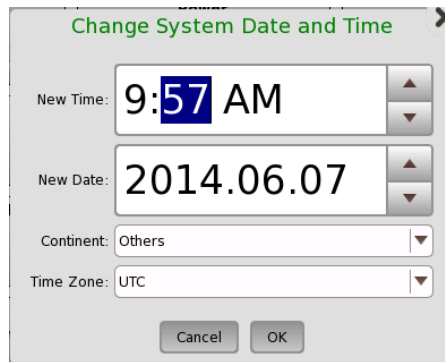

If touching **OK**, the dialog box confirming the reboot appears. Touch **Yes**.



At the battery operation, Network Master does not reboot. Date and Time will be changed when Network Master has booted by pressing the power button.

Miscellaneous

Logging Level allows you to specify the logging level. Select **Off** always. Other options are used for the service use.

Show Confirmations allows you to specify whether showing the prompts to confirm dependencies. This setting is applied for MU100010A 10G Multirate Module.

Show Test Summary allows you to specify whether to show the summarized Test Status in the Status Bar. This setting is applied for MU100010A 10G Multirate Module.

CSV Delimiter allows you to specify the delimiter character to be used when generating output of Comma Separated Values.

Performance Verification Period is used to calculate the performance validation due dates. Due dates are not calculated if the period is set to zero.

Enable Auto Power Up controls whether the Network Master starts automatically when the external power is applied.

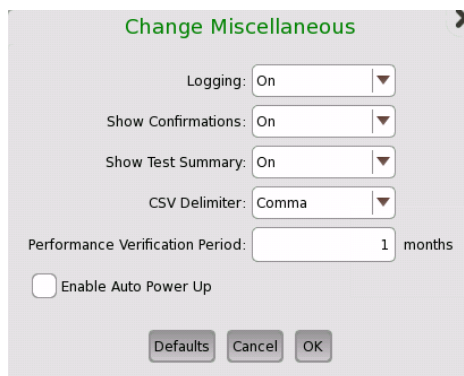

Restore Applications Defaults

Touching **Restore Applications Defaults** restores each application settings to defaults.

Execute Self Test

Touching **Execute Self Test** starts the self test.



*Save the measurement results or settings of the running applications before executing the self test. Otherwise, the unsaved measurement data will be lost when Network Master reboots.
When operating with the battery, Network Master does not reboot.*

Erase Writable Partitions

Touching **Erase Writable Partitions** erase writable partitions.

Network

The **Network** screen contains the following configuration options for the instrument's network connection:

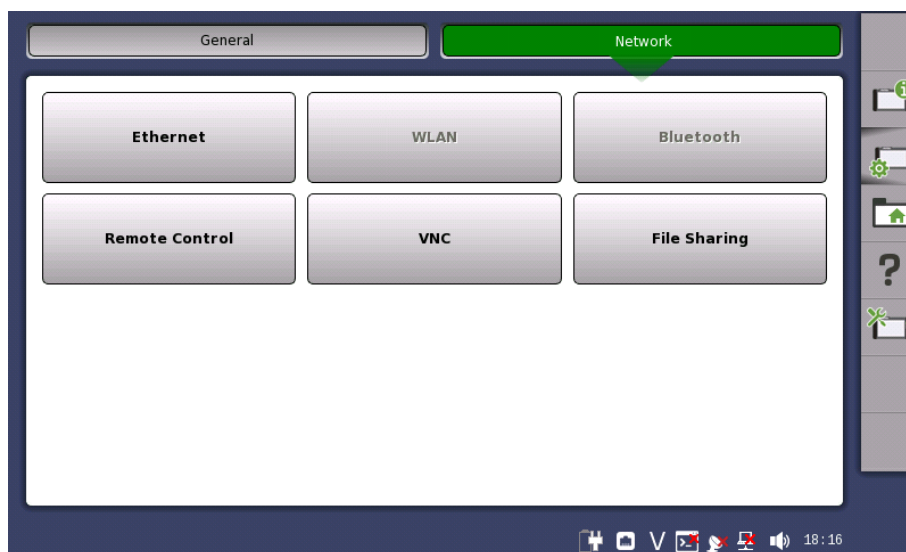

Ethernet

Allows the instrument to be connected to the Ethernet either via dynamic addressing (*DHCP*) or via manual specification of IP address, subnet mask and default gateway. These settings are applied for the [Ethernet service interface](#).

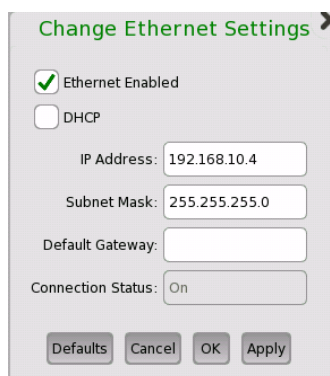

 This icon on Status bar indicates the link status of the Ethernet service interface.

WLAN

Allows the instrument to connect to a network via Wireless Local Area Network (WLAN). Note that if WLAN is enabled, the instrument cannot connect to the Ethernet via the Ethernet setting mentioned above.



This feature requires an option (MT1000A-003).

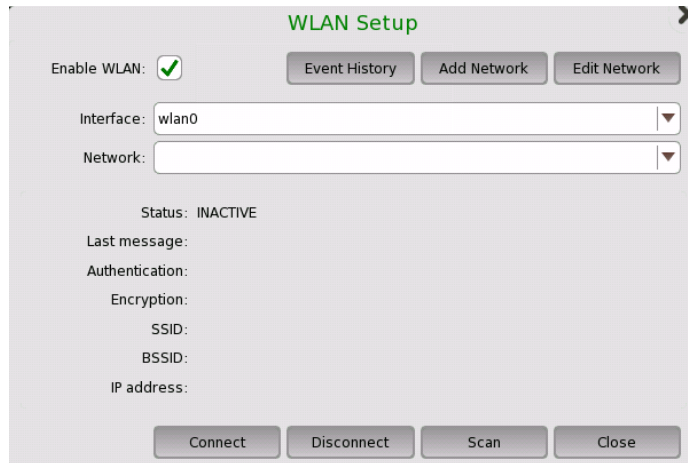

1. Touch the **WLAN** button. WLAN Setup dialog box appears.
2. Touch the **Scan** button. Scan results are displayed.
3. Select the network from scan results and touch the **View** button.
4. Touch the **Add Network** button. Specify relevant items of network, touch the **Add** button.
5. Confirm that Status in WLAN Setup dialog box changes to **Connected**.

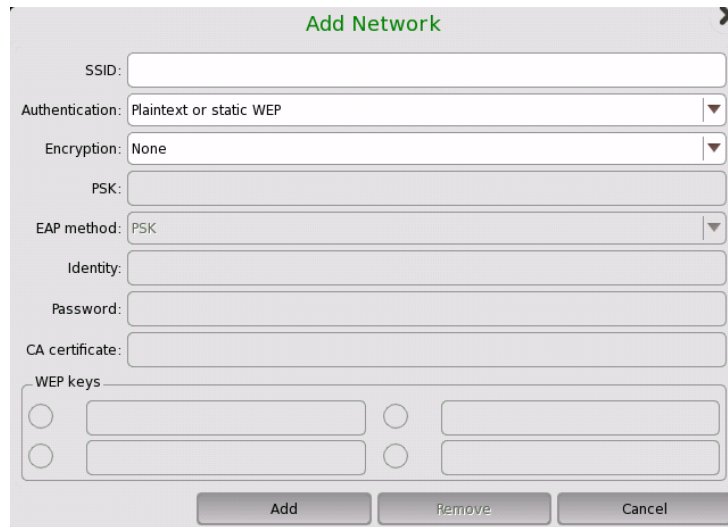

 When the option is installed, this icon on Status bar indicates the connection status of the WLAN.

To edit the settings of the current network, touch the **Edit Network** button.

The **Event History** button is available to diagnose the WLAN connection.

Bluetooth

Allows the instrument to use a Bluetooth connection.



This feature requires an option (MT1000A-003).

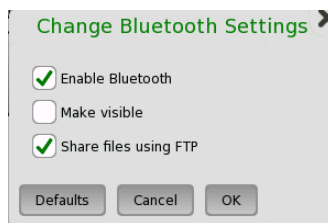

- **Enable Bluetooth:** Enables using the Bluetooth.
- **Make visible:** Allows to discover Network Master from other Bluetooth devices.
- **Share files using FTP:** Allows to share files stored in Network Master via Bluetooth. Login account and password are not required for the FTP connection. Shared folder in Network Master is "/property/mnt/internal".

 When the option is installed, this icon on Status bar indicates whether the Bluetooth is enabled or disabled.

Remote Control

Allows you to specify a TCP port for the command-based remote control of the instrument.

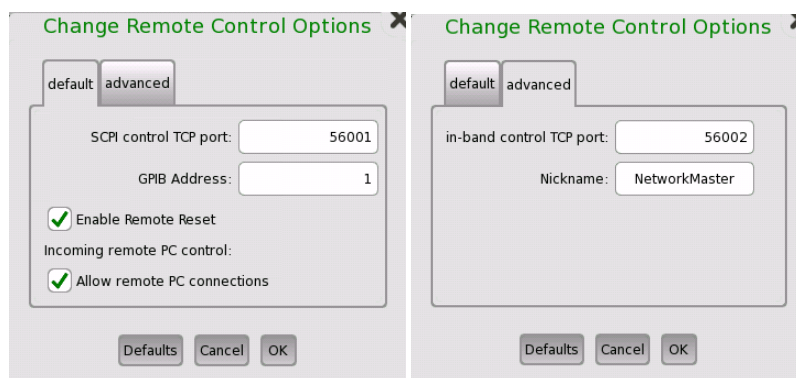

- **SCPI control TCP port:** Touch the field to set port number.
- **GPIB Address:** Touch the field to set General Purpose Interface Bus (GPIB) address.
- **Enable Remote Reset:** Selecting the check box allows users to reset the Network Master from remote PC.
- **Allow remote PC connections:** If selecting check box, remote PC control via Ethernet is available.
- **In-band control TCP port:** Touch the field to set port number used for remote control via a test interface of MU100010A. Be sure to set different number from **SCPI control TCP port**.
- **Nickname:** Network Master name which will be recognized in Discovery application of MU100010A.



Advanced tab settings are not used in OTDR module applications.

 This icon on Status bar indicates whether the remote PC control is connected or not.

VNC

Allows remote control of the instrument via Virtual Network Computing (VNC).

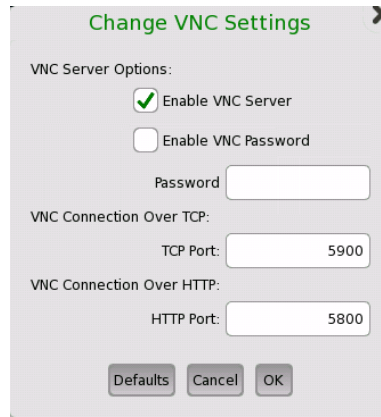

V This icon on Status bar indicates whether the VNC is enabled or disabled. Touching this icon enables or disables the VNC alternately.

File Sharing

Select **Share File System** to allow to share the data folder on networked PC. Selecting **Mount Remote Folder** enables the parameter fields for mounting the folder of networked PC.

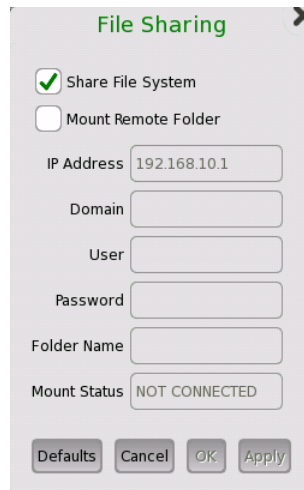

- **IP Address:** The IP address of the networked PC
- **Domain:** The domain name of the networked PC
- **User:** The username (account) of the networked PC
- **Password:** The password for account
- **Folder Name:** The name of the shared folder on the networked PC

After entering parameters, touch **Apply**. If mounting remote folder succeeded, "CONNECTED" will be shown in **Mount Status** field.



Only enter the name of the shared folder, not the entire path shown in Windows displays.

Procedure of creating the shared folder on the networked PC:

1. Create the folder in the PC.
2. Right-click on the folder and click Property.
3. Click Sharing tab, and click **Share** button to set shared.









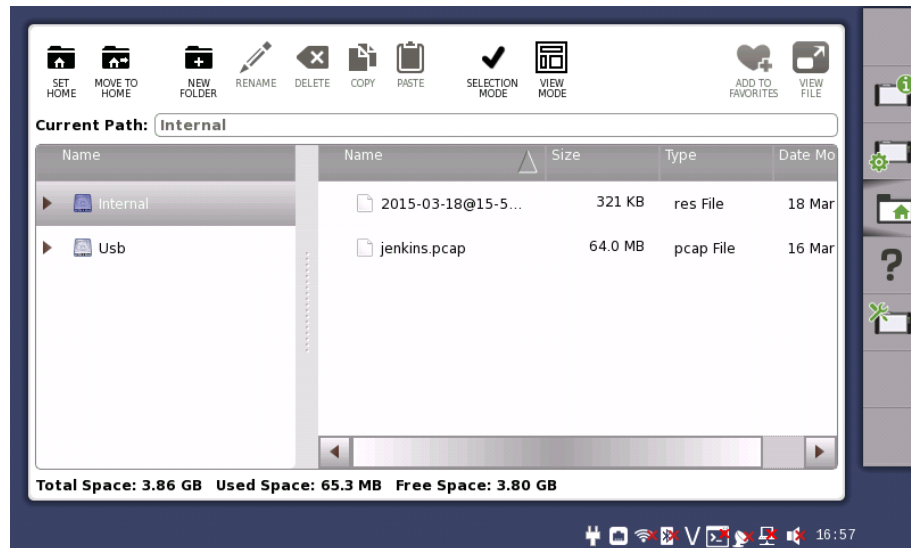





The PC shared folder will be mounted to the instrument Internal\remote folder.

File Manager



The *File Manager* icon launches the file manager screen. From this screen it is possible to configure the instrument's internal file storage facility as well as to perform all kinds of file transactions, both internally and from/to any external file storage source (USB memory stick etc.).







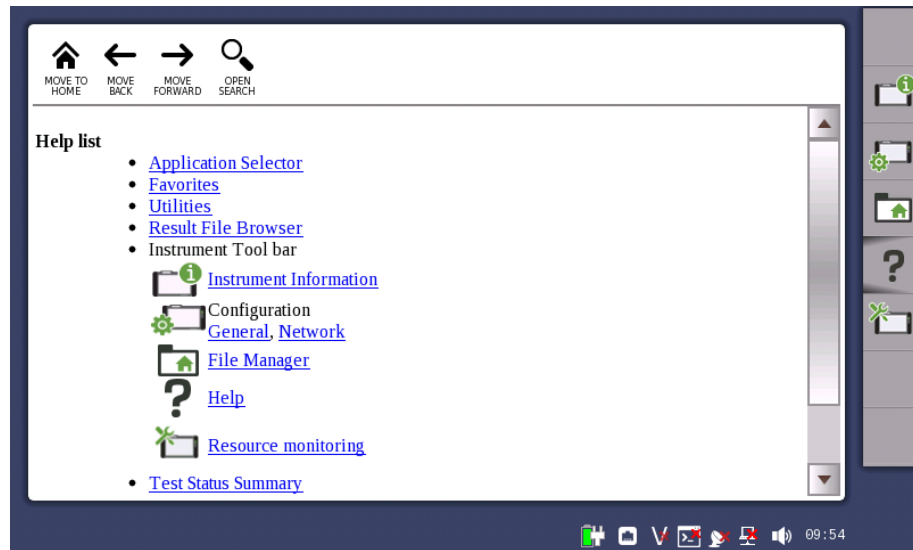

-  Appears on the remote control application screen only.
Displays the local folder of the control PC.
-  Appears on the remote control application screen only.
Displays the folder of the Network Master.
-  Sets the current folder to the home folder.
-  Moves to the home folder.
-  Creates a new folder.
-  Edits the file name or the folder name.
-  Deletes the selected file(s) or folder(s).
-  Copies the selected file(s) or folder(s).
-  Pastes the file(s) or folder(s).
-  Selects a file or a folder.
-  Selects multiple files or folders.
-  Switches the GUI layout.
-  Adds the selected files (.cfg) to "Favorites".
-  Shows contents of a text file.

Help



The *Help* icon launches the help screen with context-related help. You can search for specific words or phrases in the help and also step through previously displayed help topics.



-  Moves to the Help list topic.
-  Back
-  Forward
-  Shows/hides the search box and buttons at bottom.
-  Searches backward.
-  Searches forward.

When **Case Sensitive** is selected, searches distinguishing the upper case and the lower case.

Resource monitoring



The **Resource monitoring** icon launches a screen showing which applications are currently activated and which ports on the connector panel are assigned to each of the applications.

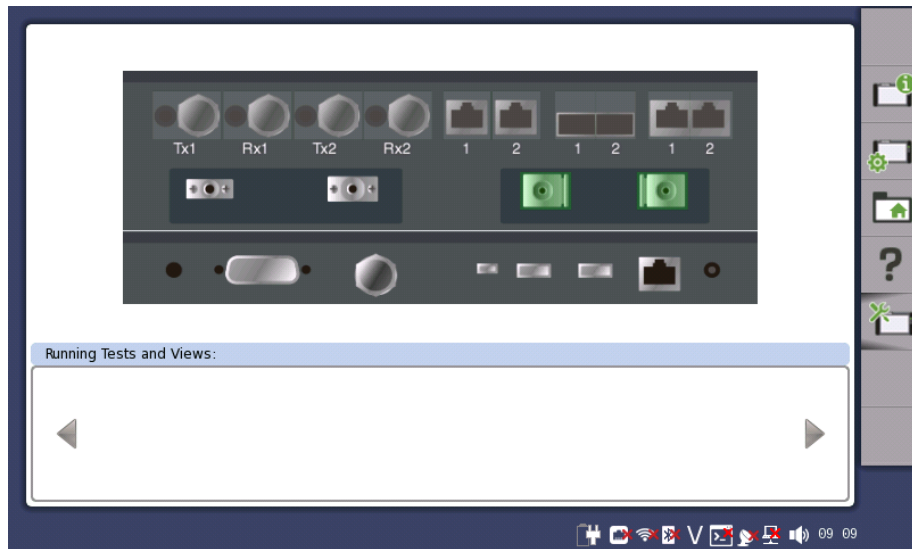

4.2.2 Application Toolbar

The *Application toolbar* consists of two columns plus the *Instrument toolbar*. You can expand/collapse the toolbar as shown in the figure below. The left-most column, which is always displayed, contains the commonly used functions.

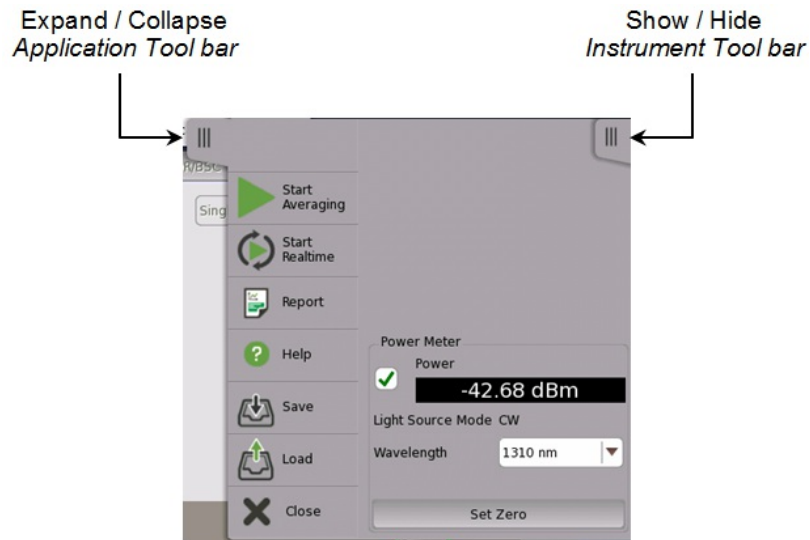

Left-most column

The left-most column contains the following functions and status indicators:

Start Averaging



Touch the **Start** icon to start the averaging test. The icon changes to the **Stop** icon shown below, which can then be used to stop the test.

Stop



Touch the **Stop** icon to stop the currently running application/test. When the test has stopped, the icon changes to the **Start Averaging** icon shown above.

Start Realtime



Touch this icon to start the realtime test.

Report



Touch this icon to create a report containing the current application results and settings.

1. Touch the **Select Report** field to select the format of the report file.

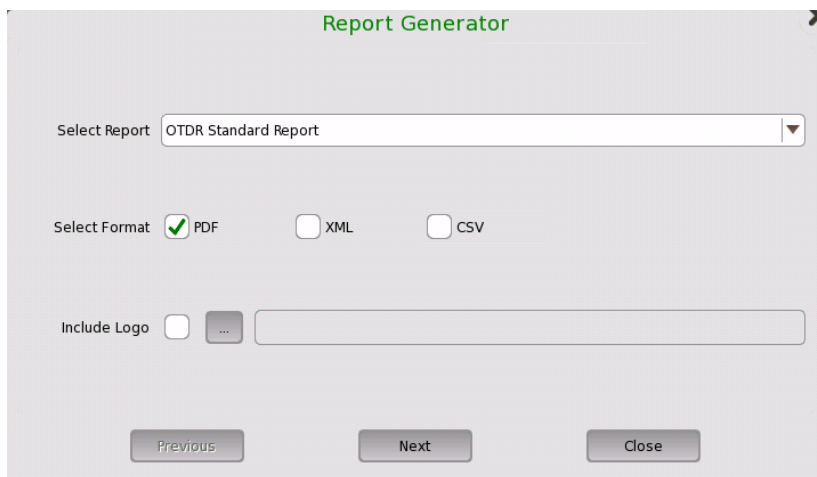

2. Select the file format of Report file using check boxes of **Select Format**.
3. To print a logo in the report, select the **Include Logo** check box. Touching ... button launches the dialog box selecting a file.
4. Touch **Next** button.

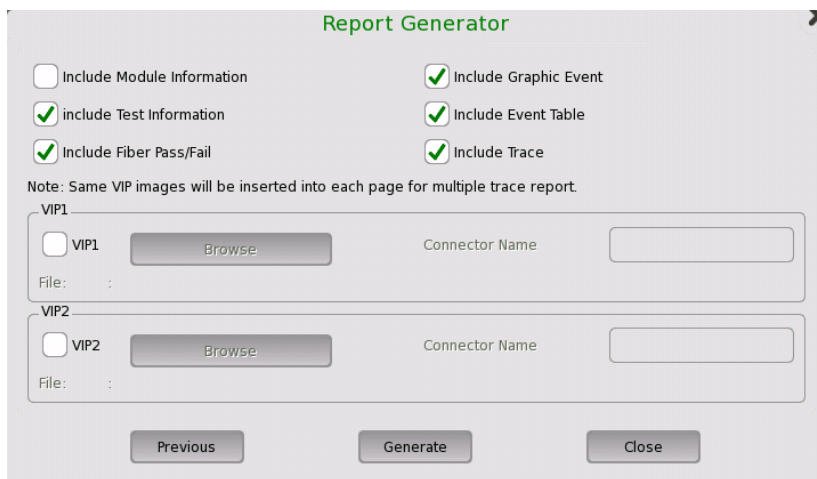

5. Select check boxes of items outputting to the report.
6. When selecting **VIP1** or **VIP2**, touch **Browse** button to set VPIP file name.
7. Touching **Generate** button starts the report generation.



Adobe® Reader® is recommended as a PDF viewer to open or print out the report.









Creating reports from the Result File Browser will not take up port resources on the system. From the Result File Browser, select the result file for which you want to create a report and touch the Report icon (📄).

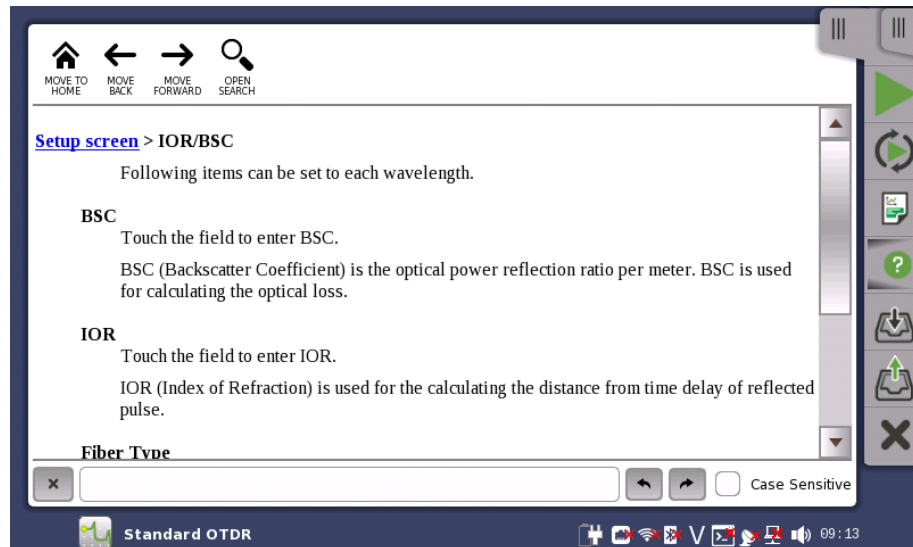

Help

Touch this icon to access the online help for the currently displayed screen or dialog box. You can search for specific words or phrases in the help and also step through previously displayed help topics.



-  Moves to the topic when touching the help icon.
-  Back
-  Forward
-  Shows/hides the search box and buttons at bottom.
-  Searches backward.
-  Searches forward.

If **Case Sensitive** is selected, searches distinguishing the upper case and the lower case.

Save



Touch this icon to open Save dialog box. You can save Setup file or Result file.

Touch **File name** field to enter the file name.

Touch **Save Setup** to save the test setup parameters.

Touch **Save Results** to save test results and the test setup parameters.

There are following types for saved files:

- | | |
|--------------------------------|---|
| Result files (*.sor) | The file which has the test results of a single trace and the test setup parameters. However, parameters in following screens are not saved. <ul style="list-style-type: none"> • Preferences in the Setup screen |
| Result files (*.zip) | The file which has the test results of dual traces and the test setup parameters. Two result files (*.sor) are zipped into this file. |
| Setup files (*.cfg) | The file which has all parameters of the Setup screen and the Test screen. |
| Analysis results files (*.csv) | The file which has Bi-directional analysis results. |



Load

Touch this icon to open Load dialog box. You can load Setup file or Result file. If touching a file on the list, the file name appears in the **File name** field. Selecting **Files of type** filters files on the list.

- Load Setup** Loads a setup file (*.cfg).
- Load Result Primary** Loads a test result file (*.sop or *.zip).
If loading a result file (*.sop), the primary trace is overwritten.
- Load Result Primary W/ Setup** Loads a test result file (*.sop or *.zip).
If loading a result file (*.sop), the primary trace is overwritten and the application test setup will change according to parameters in the loaded file. However, the parameters in the following screen are not overwritten.
 - **Preferences** in the **Setup** screen
- Load Result Overlay** Loads a test result file (*.sop or *.zip).
If loading a result file (*.sop), the overlay trace will be appended. Overlay trace can be appended up to 12.
- Load Result Overlay W/ Setup** Loads a test result file (*.sop or *.zip).
If loading a result file (*.sop), the overlay trace will be appended. And the application test setup will change according to parameters in the loaded file. However, the parameters in the following screen are not overwritten.
 - **Preferences** in the **Setup** screen

When [FTTA](#) application is running, only **Load Result Primary** button appears.



When loading setup files, the output port setting (Single Mode or Multi Mode) enclosed in the file has to match that of the current application.

When loading compressed result file (.zip), the current traces are cleared and overwritten with loaded results.*



Loading result files into a viewer will not take up port resources on the system. This is practical if you only want to review previous results and don't need to run test again. From the Result File Browser, select the result file you want to view and touch the View icon (👁️) at right hand top of the screen.

Close



Touch this icon to close the application.

Expanded Application toolbar

The *Application toolbar* is expanded/collapsed by touching the  tab placed above the left-most column. The column displayed in the expanded toolbar contains the power meter function. Select check box to display the measured power.

Touch the **Wavelength** field to select the wavelength of input light. When Light Source Mode is **Wave Code**, the wavelength value is set automatically.

To calibrate zero level of the power meter, touch **Set Zero**.
Disconnect the optical fiber from the connector and close protective cover,
then touch **OK**.

4.3 Startup and Switch-off Sequences

This section describes what takes place when you switch the Network Master on and off as well as when you start up and close down an application.

4.3.1 Instrument Startup

When you switch on the instrument, the first screen displayed is a splash screen - introducing you to the GUI concept of the *desktop/workspace* and the various screen types (see the figure in the *GUI Concept* section). Then the [Application Selector](#) screen is displayed.

4.3.2 Application Startup

When you touch an icon on the *Application Selector* screen to start an application, a *workspace* is created for that application and the relevant data is loaded into it. When the loading is complete, the *Setup* screen is displayed, with the interface type(s) relevant for the selected application.

You can also start an application by selecting the result file on the *Report File Browser* screen. Refer to the next section.

4.3.3 Accessing Previous Tests and Test Results

When you select test result files on the *Report File Browser* screen, you can choose to create either a report from the results or a *workspace* containing the test setup data and its results.

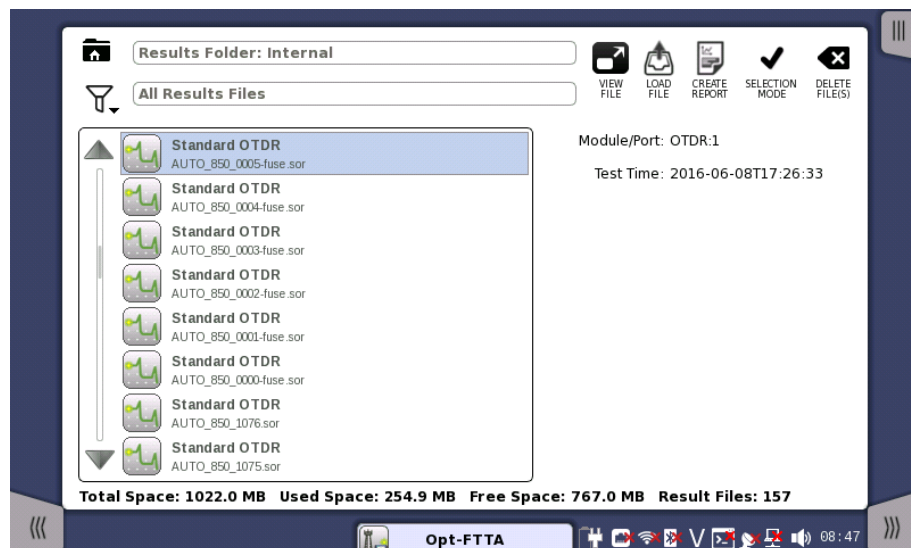

Creating a *workspace* for a previous test allows you to view the test results in the GUI. You are brought directly to the *Test Results* screen when you touch the **View/Load File** button, but can navigate to the other screens in the workspace from there.



When you touch the **VIEW FILE** button, an application starts in *Viewer* mode. In this mode, you cannot start measurement. This mode is used to view the test result.

If selecting *.sor or *.zip file, touch a button for specifying the application.



When you touch the **LOAD FILE** button, an application starts using the setting in the file. If selecting *.sor or *.zip file, touch a button for specifying the application.

If other application is using ports, the following message appears. In this case, you can start the application in *Viewer* mode.

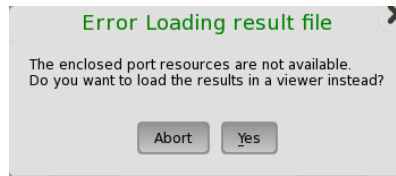

When you touch the **CREATE REPORT** button, the Report Generator dialog box is displayed, allowing you to name and save the report (in PDF format).

Select the report type by using **Select Report**. The report is created by using Pass/Fail thresholds of the selected application.

4.3.4 Closing an Application

When you touch the **Close** icon in the *application toolbar*, you are prompted to confirm that you really want to close the current application. If you touch "Yes", the *workspace* is closed and you are returned to the *desktop* (i.e. the *Application Selector* screen). The resources previously allocated to the application are freed to be used by another application if required.

4.3.5 Switching Off the Instrument

When you press the [Power button](#) on the instrument, the power-off menu is displayed. The menu contains the menu item **Shut Down**, and when you select that, you are prompted to confirm that you really want to switch off the instrument completely.

If you touch "Yes", the shutdown is announced, and then after a few moments the power is turned off.



If you have any applications still active when you switch off the instrument, these applications will be closed automatically without any configuration data and/or test results being saved.

5 Optical Fiber Testing Applications

This chapter describes the graphical user interface (i.e. screens, subscreens and major dialog boxes) related to Optical Fibre Testing applications. Subscreens and dialog boxes are described under the main screen from which they are activated/launched.

The following applications are available:

- [Standard OTDR](#)
- [FTTA](#)
- [Construction](#)
- [OLTS](#)

5.1 Standard OTDR



Standard OTDR (Optical Time Domain Reflectometer) application allows users to locate fault of an optical fiber. The test result is displayed on Fiber Visualizer screen or Trace screen.

5.1.1 Measurement Condition Setup

The first step in running an application is to set up the measurement conditions. This is done on the **Setup** screen, which also provides port status information.

5.1.1.1 Port

Touching the **Port** button in the navigation area will launch the following screen.

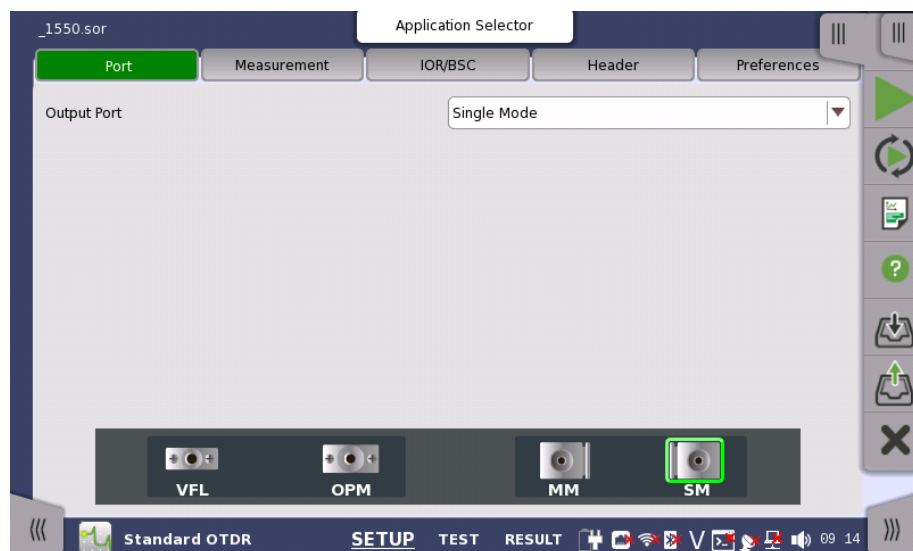

Output Port

Touch the field to select the port used for the test.

- MU100020A, MU100022A: Fixed to **Single Mode**.
- MU100021A: **Single Mode, Multi Mode**

The connector of the selected port will be marked on the image.

Selecting **Single Mode** allows users to test the optical fiber compliant ITU-T G.652 "Characteristics of a single-mode optical fibre and cable".

Selecting **Multi Mode** allows users to test the Grated Index (GI) fiber of diameter 50 μ m or 62.5 μ m.

5.1.1.2 Measurement

Touching the **Measurement** button in the navigation area will launch the following screen.

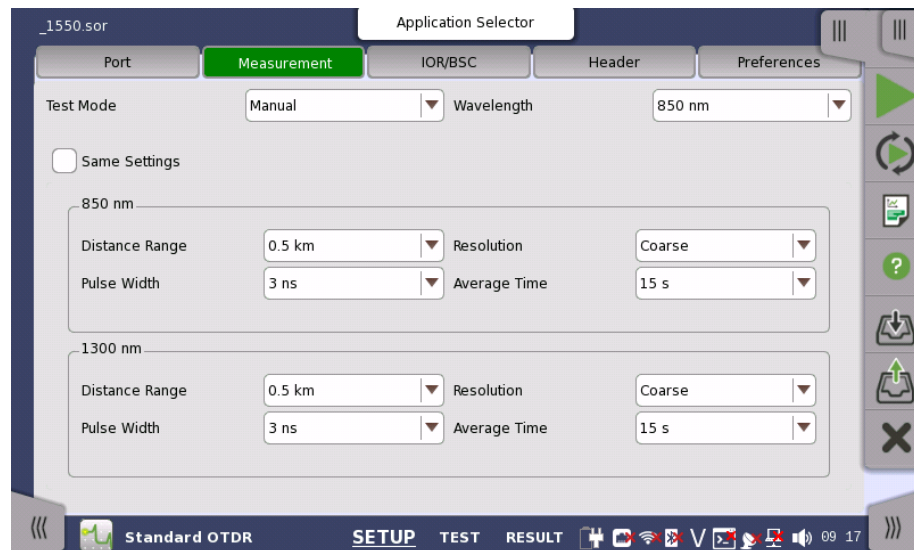

Test Mode

Touch the field to select the test mode.

If selecting **Auto**, the parameters will be set automatically.

Selecting **Manual** allows user to set parameters.

Wavelength

Touch the field to select the wavelength used for the test.

Selecting **ALL** will test in all wavelength which the OTDR module supports.

| Output Port | Available wavelength |
|-------------|--------------------------------|
| Single Mode | 1310 nm, 1550 nm, 1625 nm, ALL |
| Multi Mode | 850 nm, 1300 nm, ALL |



Available wavelength depends on the model.

Same Settings

Select the check box if applying the same settings for all wavelengths.

Following items can be set to each wavelength.

Distance Range

Select the upper limit of distance to locate faults.

Pulse Width

Select the pulse width of optical signal. As the time unit, "us" is used in place of " μ s".

Resolution

Select the resolution in horizontal.

Average Time

Select the averaging time of measured traces applied for **Start Averaging**.

5.1.1.3 IOR/BSC

Touching the **IOR/BSC** button in the navigation area will launch the following screen.

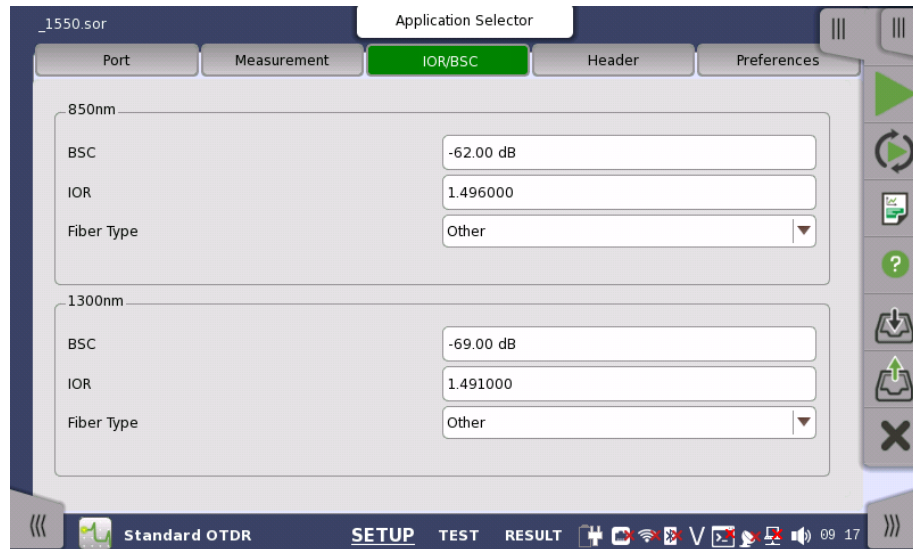

The following items can be set to each wavelength.

BSC

Touch the field to enter BSC.

BSC (Backscatter Coefficient) is the optical power reflection ratio per meter. BSC is used for calculating the optical loss.

IOR

Touch the field to enter IOR.

IOR (Index of Refraction) is used for calculating the distance from time delay of reflected pulse.

Fiber Type

Select the fiber.



*The values set in this screen are applied to the trace measured next time and later. To change IOR and BSC of the following trace, use **IOR** of the Trace screen.*

- *Current trace*
- *Loaded trace from a file*

5.1.1.4 Header

Touching the **Header** button in the navigation area will launch the following screen.

The screenshot shows the 'Header' tab of the Standard OTDR application. The form is titled '_1550.sor' and 'Application Selector'. The 'Header' tab is active, showing the following fields and values:

| Field | Value |
|-----------------|-----------|
| Data Flag | BC(built) |
| Cable ID | alfa |
| Fiber ID | beta |
| Cable Code | gamma |
| Location A | osaka |
| Location B | tokyo |
| Direction | A->B |
| Operator | aaa |
| Comment | bbb |
| Sequence Number | 9 |

The bottom of the screen shows the 'Standard OTDR' logo and navigation buttons for 'SETUP', 'TEST', and 'RESULT'. The system tray at the bottom right shows the time '09 17'.

In this screen, the contents of File header which will be stored in the result file (*.sor) can be set.

Next items are printed in [Report](#).

Cable ID, Fiber ID, Location A, Location B, Operator

Data Flag

Selects the data flag of the measured traces

- **BC(built)**: The trace which was measured when the cable was built.
- **RC(repair)**: The trace which was measured when the cable was repaired.
- **OT(other)**: The trace which was measured in other case.

Cable ID

Sets the ID of the measured cable.

Fiber ID

Sets the ID of the measured fiber.

Cable Code

Sets the cable code of the measured cable.

Location A

Sets the location name at measurement start.

Location B

Sets the location name at measurement end.

Direction

Selects a direction to be measured.

A -> B: Location A to Location B

B -> A: Location B to Location A

Operator

Sets the the measured person's name.

Comment

Sets the comment concerned to the measured trace.

Sequence Number

Sets the starting number of the sequence number included in the header.

5.1.1.5 Preferences

Touching the **Preferences** button in the navigation area will display four tabs.

Measurement

Touching the **Measurement** tab displays the following screen.

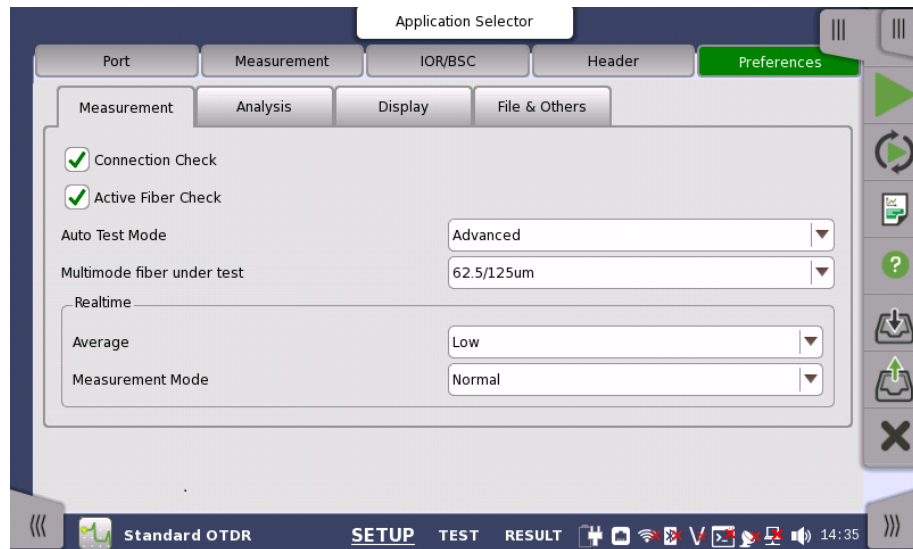

Connection Check

The [Connection Check](#) function confirms whether or not the fiber is connected correctly to the OTDR measurement port.

Active Fiber Check

The Active Fiber Check performs a "live fiber" check on the currently attached fiber under test to detect whether the fiber is carrying traffic before firing any OTDR laser sources.

- If no traffic is detected, the test proceeds normally.
- If traffic is detected, a warning message appears on the screen and the test is aborted.



The Active Fiber Check feature does not apply to the 850/1300 nm multimode fiber.

Auto Test Mode

Select the type of Auto Test.

- **Advanced:** Tests using multiple pulse widths to detect the events precisely. However, this test mode takes a long time to measure, because of repeating tests by varying pulse width.
- **Standard:** Tests using a fixed pulse width.

This setting appears when **Multi Mode** is selected on Port screen. Select the core diameter of the multimode fiber under test. "um" is used in place of " μ m".

Realtime

Set how to process a Realtime Measurement (🔄).

Averages

Select whether to perform averaging in Realtime Measurement.

- **Low:** Does not perform averaging.
- **High:** Performs averaging. Set this to suppress the OTDR noise when the distance range to measure is long.

Measurement Mode

- **Normal:** Set this when measuring the back scatter light from the optical fiber.
- **High Reflection Measurement:** Set this when measuring the trace that large level differences are included such as Fresnel reflections. This mode takes longer measurement time than the **Normal** mode.

Analysis

Touching the **Analysis** tab displays the following screen.

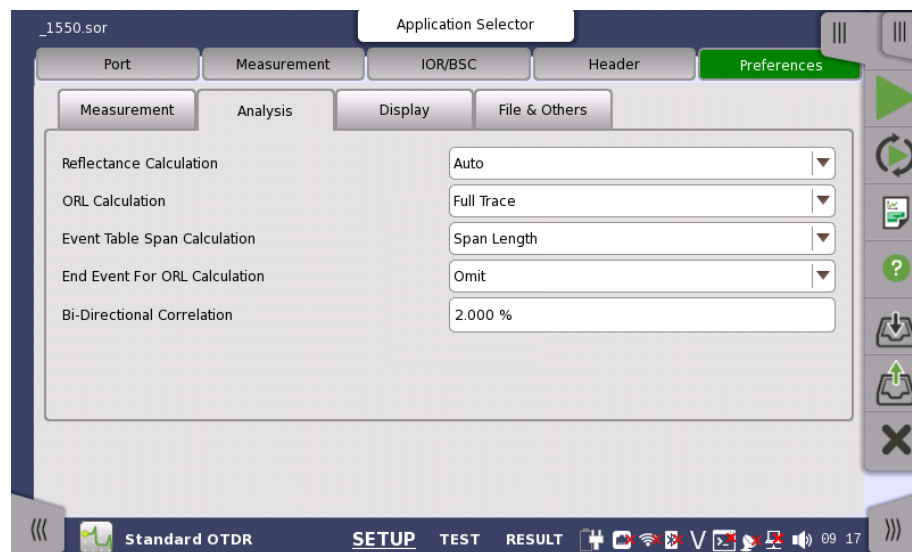

Reflectance Calculation

Select the reflectance calculation method.

- **Off:** Reflectance will not be calculated.
- **Auto:** The reflectance of any event is reported based on the position of cursor A. The Auto setting is most useful for reflective events that are not close together or close-in to the OTDR.
- **Manual:** When set to Manual, the reported reflectance is based on the positions of both cursors (A and B). The Manual setting is most useful for reflective events that are close together or close-in to the OTDR.

For details, refer to [Reflectance](#).

ORL Calculation

Select the starting point for ORL (Optical Return Loss) measurements.

- **Cursor A:** The ORL measurement is calculated from the cursor A to the cursor B, but the Incident Power is attained from the A cursor position.
- **Origin:** The ORL measurement is calculated from the cursor A to the cursor B, but the Incident Power is attained from the origin (e.g.: 0 km, or Bulkhead connector).
- **Full Trace:** The ORL measurement is calculated from the Origin to the last data point, and the Incident Power is attained from the origin (e.g.: 0 km, or Bulkhead connector).

Event Table Span Calculation

This item appears for OTDR application. Selects whether to display the span length or transmission loss (dB/km) on event table. This setting function applies only to Event Table in the Trace screen.

End Event For ORL Calculation

Set whether to include reflection in Far-End events or not when calculating the ORL. This setting function applies to the following.

- Fiber Visualizer
- ORL Calculation in Trace screen when **Full Trace** is selected for ORL Calculation

Bi-Directional Correlation

Enter the value to define the range for detecting the same event on Overlay trace in reversed direction which is displayed by [Bi-Directional](#) on the Trace screen.

The range is defined as Far End event distance of Primary trace multiplied by Bi-Direction Correlation/100.

Example:

Fiber End event distance of Primary trace: 50 km

Bi-Direction Correlation: 4%

Distance of the event on Primary trace: 12.5 km

The distance range detecting the event on Overlay trace: 11.5 to 13.5 km

Display

Touching the **Display** tab displays the following screen.

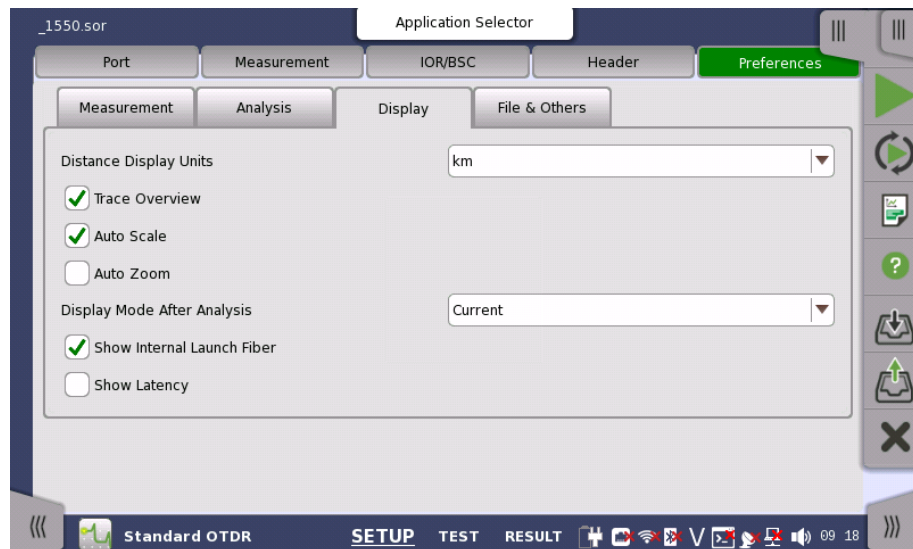

Distance Display Units

Select the unit of measurement used to display distance on the horizontal axis of the Trace graph. This affects Range and Resolution readings and analysis events incorporating distance.

Trace Overview

When the check box is selected, a small overview of the trace is displayed in the lower left portion of the Trace graph.

Auto Scale

When the check box is selected, Horizontal scale which is automatically set So that Far End event is displayed in the Trace screen.

Auto Zoom

Selecting the check box will automatically zoom in on the event selected in the Result screen.

Display Mode After Analysis

The Display Mode After Analysis setting is used to set the post-analysis display mode.

- **End/Break:** Displays the range up to the Far end event or the broken point.
- **Full Trace:** Displays full range of distance.
- **Current:** Displays the trace with the current scale settings.

Show Internal Launch Fiber

Selecting the check box will display the internal launch fiber of Network Master onto the Trace screen.

Show Latency

Selecting the check box will display the latency to the fiber end in the Fiber Visualizer screen. Latency is the time which optical pulse takes to reach the far end from origin.

File & Others

Touching the **File & Others** tab will launch the following screen.

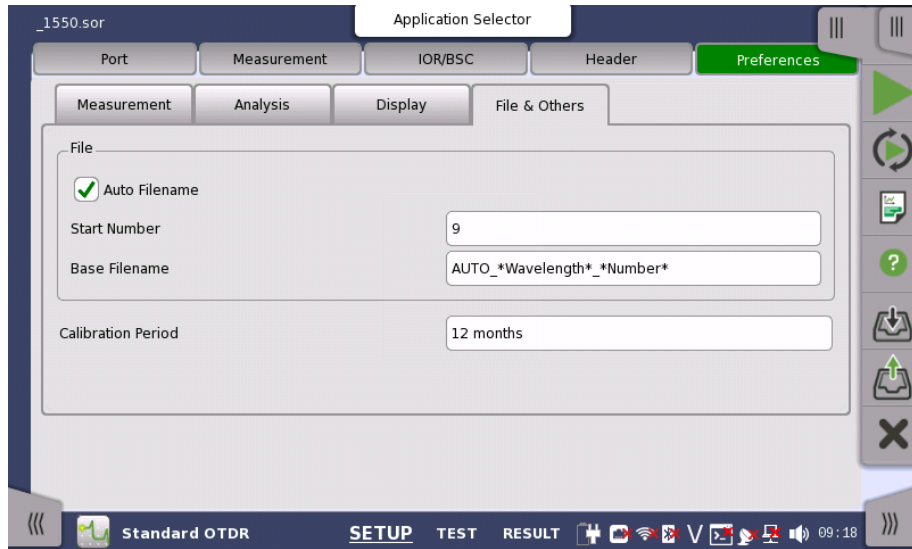

Auto Filename

Select the check box to automatically generate a filename when a save is performed.



When Auto Save in [General](#) screen is set to **On** or **Prompt**, the check box is always selected.

Start Number

Touch this field to set the starting file number of Auto Filename.

Base Filename

The Base Filename field provides a template for use when generating an auto-filename. You can enter a base filename of up to 70 characters with a three character file extension.

Calibration Period

Touch the field to set the calibration period in months.



Calibration expiration date is printed in the [Report](#).

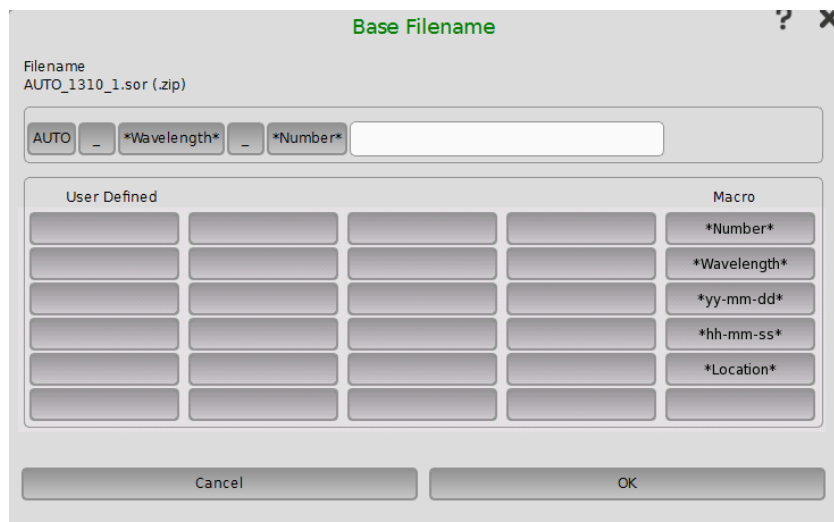

Enter the string or variables by the following way:

- Touch the white field to append strings using Keypad dialog box.
- Touch the button in **User Defined** which string is displayed.
- To enter variables such as time, touch a **Macro** button.

The entered string or variable appears as a button. When removing or editing the button, touch the button.

User Defined

Touching the blank button will launch the Keypad dialog box to edit the string. Touching the labeled button will insert that to a filename.

To edit the string on the button, keep touching the button. Keypad dialog box will launch.

Macro

Touching the button will insert the following variables in the filename.

Number

Auto numbering. Start Number can be set in the Preference 1/2.

Wavelength

The wavelength in nanometer unit used for the test.

yy-mm-dd

The tested date shown as year-month-day. Example: 2015-12-31

hh-mm-ss

The tested time shown as hour-minute-second. Example: 23-59-00

Location

Location A and Location B set to the [Header](#). Example: osaka_tokyo

5.1.2 Test Setup

5.1.2.1 Fiber

Touching the **Fiber** button in the navigation area will launch the following screen.

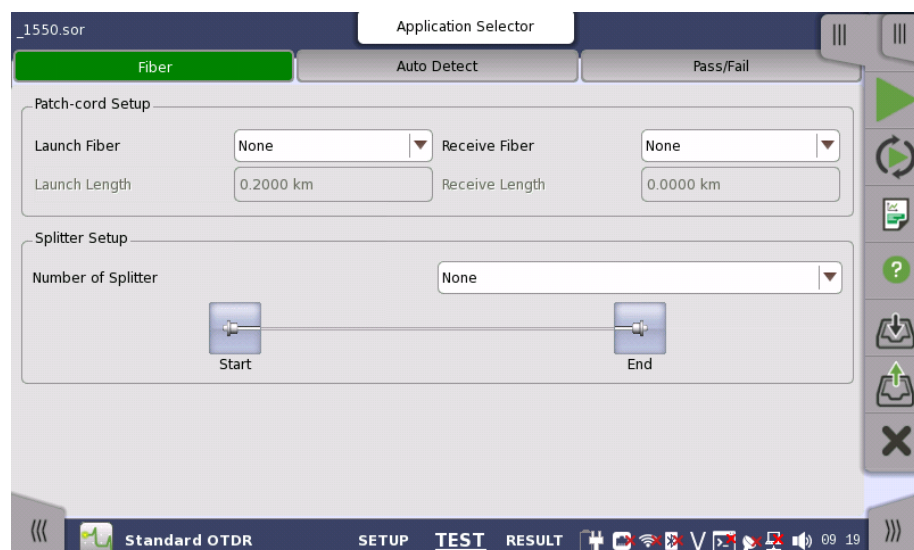

Patch-cord Setup

Patch-cord is the optical fiber connecting to the fiber under test.

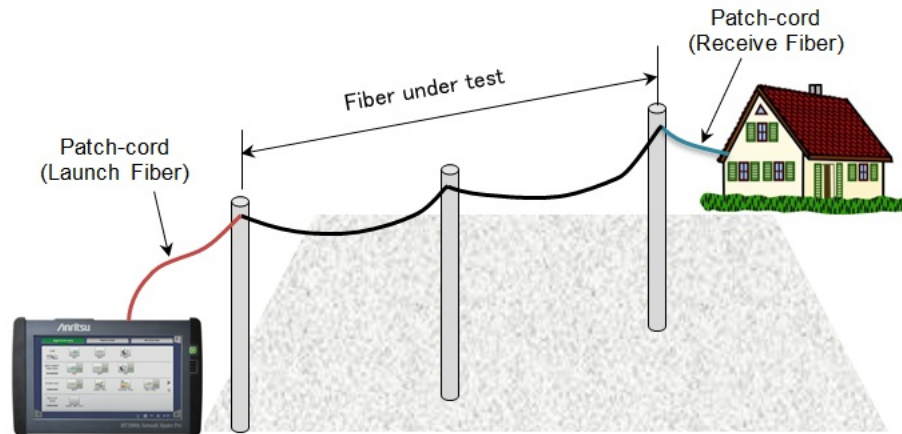

Launch Fiber

Launch Fiber is Network Master side patch cord. Select the connection point between Launch Fiber and the fiber under test.

- **None:** Does not set the Launch Fiber point.
- **Event1 to Event3:** Sets the distance of a specified event as the patch-cord length.
- **Distance:** Specify distance in **Launch Length** field as the patch-cord length.

Launch Length

Set the length of the patch-cord connected to the fiber under test at Launch Fiber when **Launch Fiber** is set to **Distance**.

Receive Fiber

Receive Fiber is the Far End side patch cord. Select the connection point between Receive Fiber and the fiber under test.

- **None:** Does not set the Receive Fiber point.
- **Event1 to Event3:** Sets the distance of a specified event to the starting point of the Receive Fiber.
- **Distance:** Sets the number in **Receive Length** field to the patch-cord length.

Receive Length

Set the patch-cord length from Far End when **Receive Fiber** is set to **Distance**.

Splitter Setup

These settings appear when Output Port is set to **Single Mode** at Standard OTDR application.

If the splitter information on the fiber is known, set the number of splitters and the number of splits.

Number of Splitters

- **None:** Does not set Splitters on the fiber.
- **1 to 3:** Sets splitters of the specified number.
- **Detect:** Detects the number of splitters automatically.

Select the number of splits by touching the field under the splitter icon. Selecting **1×??** detects the splits automatically.

5.1.2.2 Auto Detect

Touching the **Auto Detect** button in the navigation area will launch the following screen.

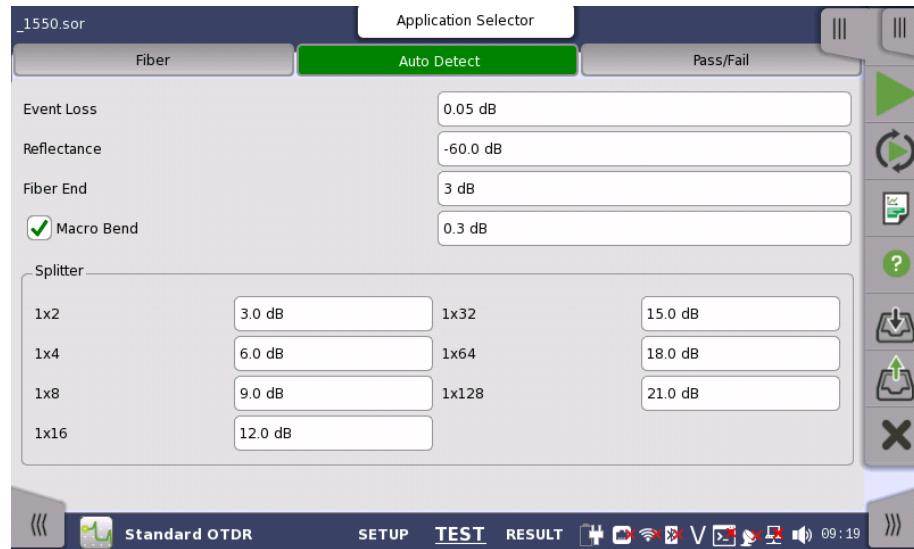

Set thresholds to detect events automatically in Auto Detect screen. Events that exceed the Auto Detect parameter settings are reported in the Event Analysis table.

Event Loss

Determines the minimum loss.

Reflectance

Determines the lowest reflectance value that will be reported by analysis. Any event with a reflectance is equal to or greater than the value in this parameter will be reported in Event analysis.

Fiber End

Determines the minimum loss for the Fiber End.

Macro Bend

This settings appear when Output Port is set to **Single Mode** at Standard OTDR application.

Select check box when analyzing Macro Bend (slight bending of the fiber).

Determines the threshold for detection as Macro Bend.

Splitter

These settings appear when Output Port is set to **Single Mode** at Standard OTDR application.

Determines the minimum loss for detection as Splitter event in the Events analysis.

5.1.2.3 Pass/Fail

Touching the **Pass/Fail** button in the navigation area will launch the following screen.

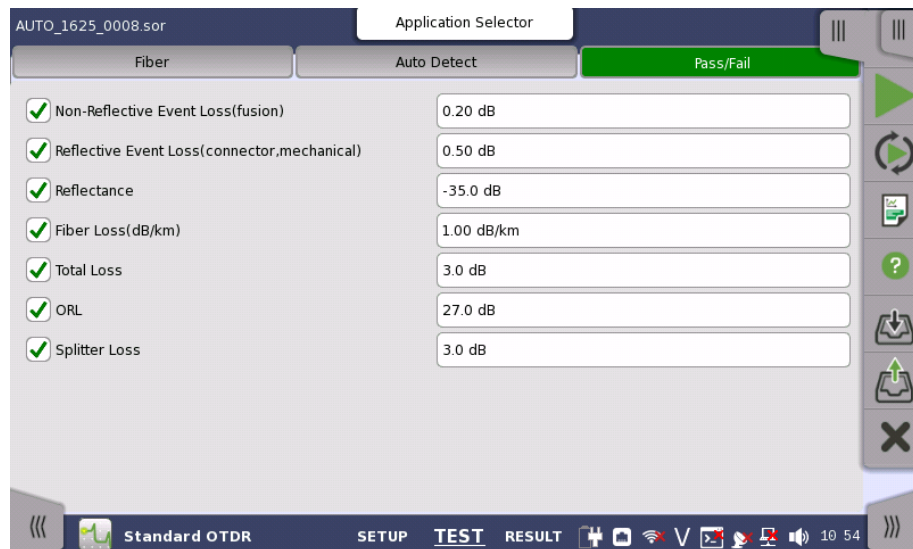

This screen allows users to set thresholds to Pass/Fail tests.

Non-Reflective Event Loss (fusion)

This parameter highlights non-reflective event losses, such as fusion splices, in the Events Analysis table.

Reflective Event Loss (connector, mechanical)

This parameter highlights reflective event losses, such as connectors and mechanical splices, in the Events Analysis table.

Reflectance

This parameter highlights events in the Event Analysis table that exceed the set Reflectance value.

Fiber Loss (dB/km)

This parameter highlights events in red in the Event Analysis table when the dB/km loss exceeds the value set.

Total Loss

When the Total loss (Cum.Loss (dB)) exceeds the value set:

- Total loss (Cum.Loss (dB) in Fiber End row) is highlighted in red.
- Total Loss value in the Fiber Visualizer screen will be displayed in red.

ORL

ORL value in the Fiber Visualizer screen will be displayed in red when the ORL (Optical Return Loss) is lower than the value set.

Splitter Loss

This setting appears when Output Port is set to **Single Mode** at Standard OTDR application.

This Parameter highlights events in red in the Event Analysis table when the splitter loss exceeds the Auto Detect threshold plus value set.

- Splitter in the [Auto Detect](#) screen
- Splitter Loss in this setting

For example, if the 1×2 splitter is set to 4.1 dB in the Auto Detect screen and Splitter loss is set to 1.0 dB, the 1×2 splitter event loss for exceeding 5.1 dB is judged as Fail.

5.1.3 Test Results

5.1.3.1 Connection Check

If selecting **Connection Check** on Measurement tab in Preferences screen, Connection Check Level will appear after starting a measurement.

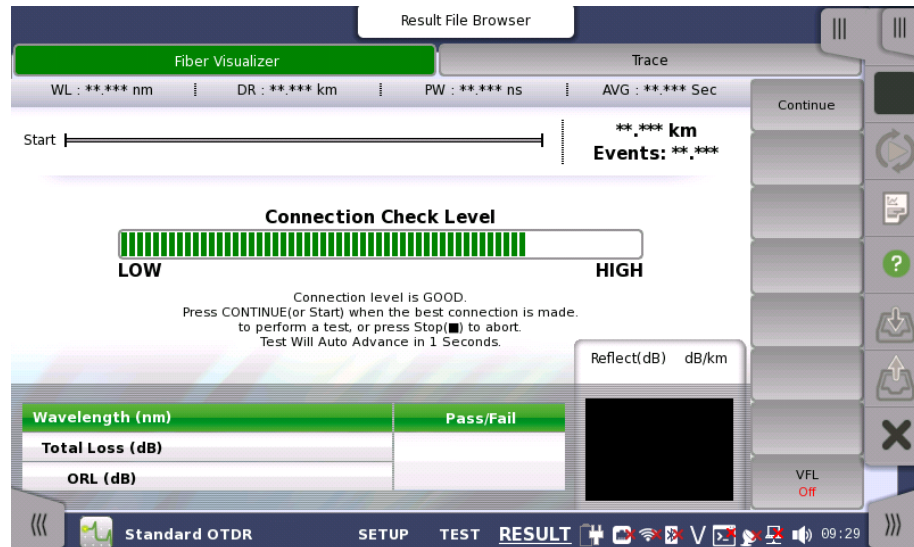

| Bar Color | Connection Loss * |
|-----------|-------------------|
| Green | <1 dB |
| Yellow | 1 to 2 dB |
| Red | >2 dB |

*: Values for reference purposes. The value may not be measured correctly depending on reflection from the optical connector or the fiber.

1.5 dB is added to each value when using a 50 μm multi-mode fiber.

Good connection

The gauge is green when connection is good. The closer the bar in the connection gauge extends to "HIGH" end, the better the connection is.

Bad connection

The gauge is red when connection is bad. And it is yellow when connection is not good. If the bar color is yellow, touch **Continue** soft key to perform the test.

If the gauge is yellow or red, the fiber needs cleaning.

If the connection state is not improved even if the fiber is cleaned, the fiber needs to be replaced.



Fibers shorter than approximately 48 meters (160 ft.) will generally result in a low connection level.

5.1.3.2 Fiber Visualizer

Touching the **Fiber Visualizer** button in the navigation area will launch the following screen.

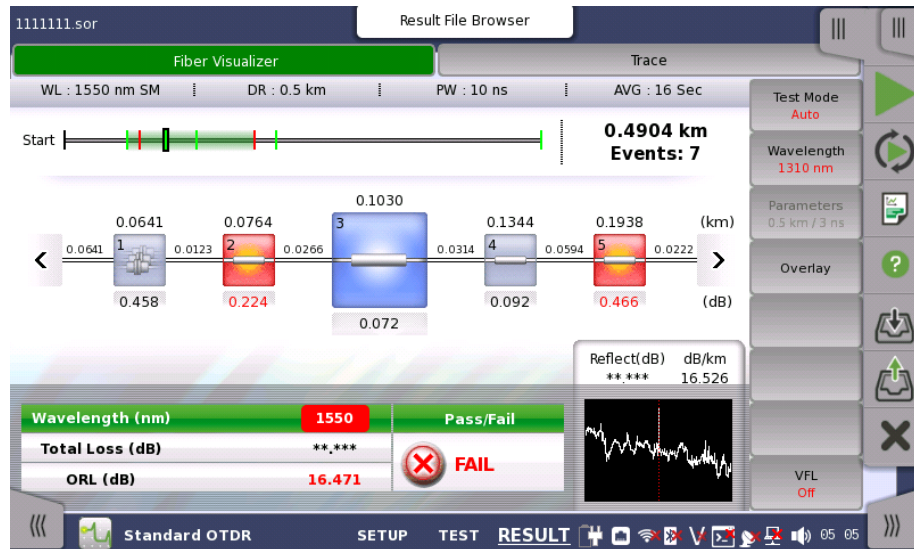

In Fiber Visualizer screen, the detected events are shown by [the icon](#). For event description, refer to [Event type](#). Icons on red are the Fail events by Pass/Fail judgement.

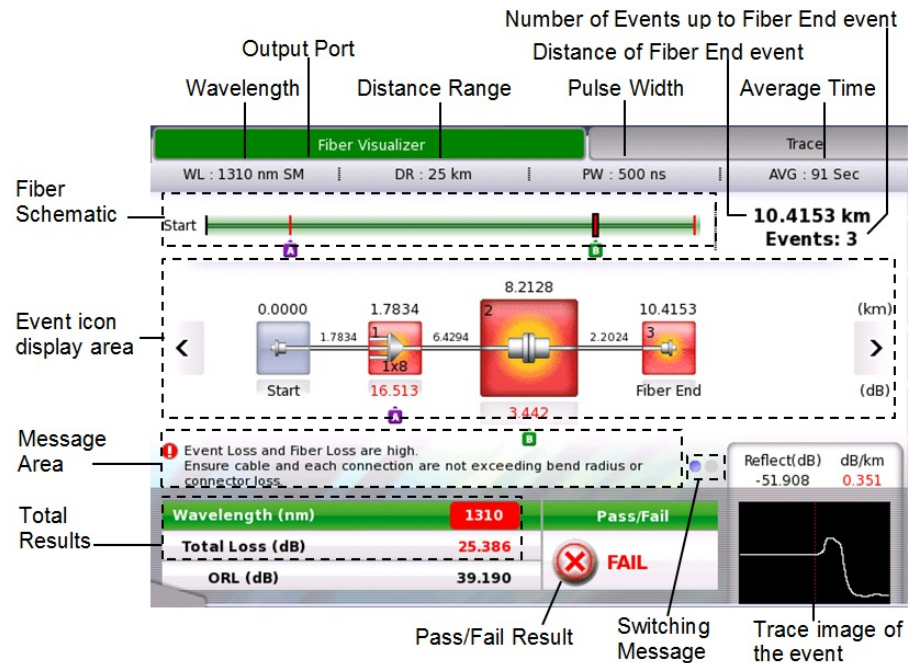

Fiber schematic

Shows event positions or event icon positions on display. The events that exceed the PASS/FAIL thresholds are displayed in red.

Event icon display area

Fiber connection points, fusion points, and splitters are displayed in icons. The events that exceed the PASS/FAIL thresholds are displayed in red.

Touching an event icon allow users to set a marker or edit the icon type.

 When Bi-Directional on Trace screen is set to **ON**, this icon appears at left of the screen.

 Displayed under an event icon if Marker A is set to the event.

 Displayed under an event icon if Marker B is set to the event.

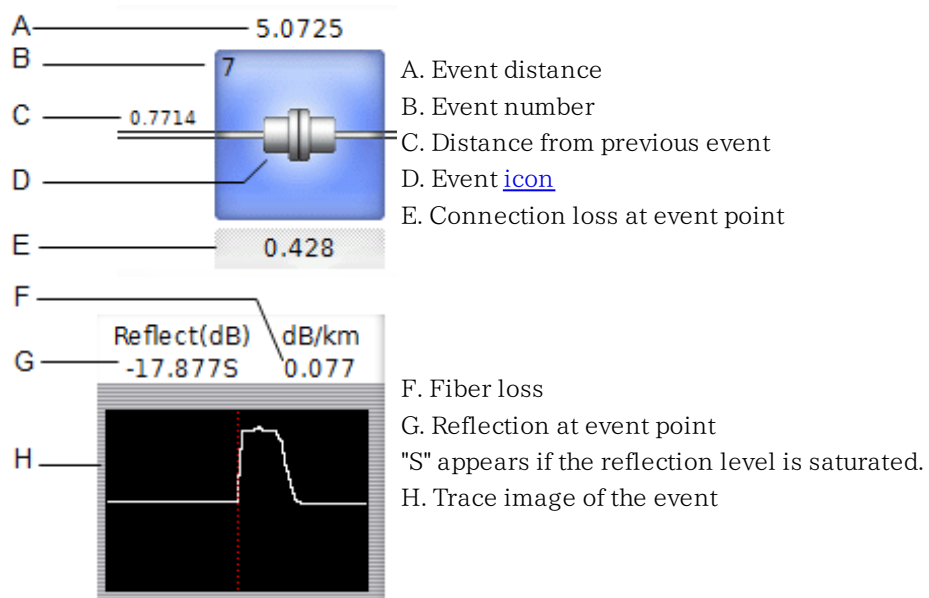

Message Area

One of following is displayed.

- When touching "Fail" icon, why it was judged as "Fail" and a hint of the solution are displayed.
- When both Marker A and Marker B are set, the distance and the loss between markers are displayed.
- When Total Loss or ORL result is displayed in red, its information is displayed.

Switching Message

When both Marker A and Marker B are set, touching an icon () switches information displayed at Message Area.

Total Results

Loss and ORL of the total fiber are displayed.

When measured by more than two wavelength, arrow appears at the side of the wavelength value.



When Total Loss or ORL result is displayed in red, touching the value displays information at Message Area.

Pass/Fail Results

If all the PASS/FAIL thresholds are cleared, "PASS" is displayed. Even if only one event fails to clear the threshold, "FAIL" is displayed.

Event Icon List

For event description, refer to [Event type](#). Icons on red are the Fail events by Pass/Fail judgement.

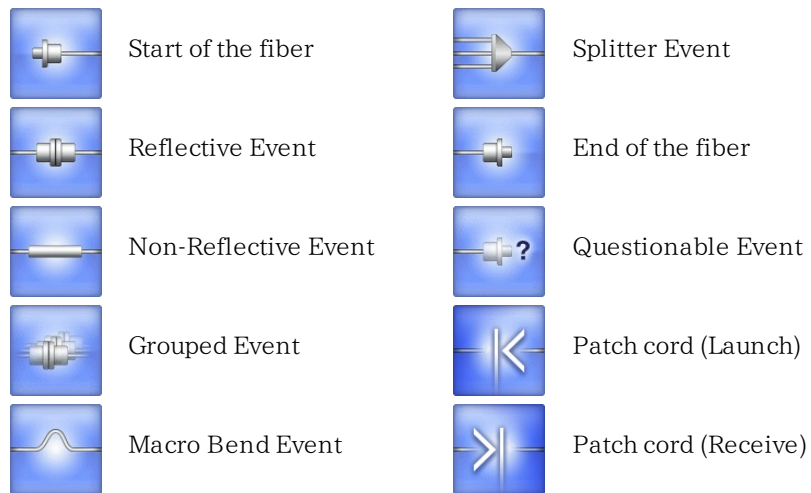

Event Edit

Touch the Event icon on the Fiber Visualizer, and touching **Event Edit** will launch the following screen. Available icons depend on the selected icon.

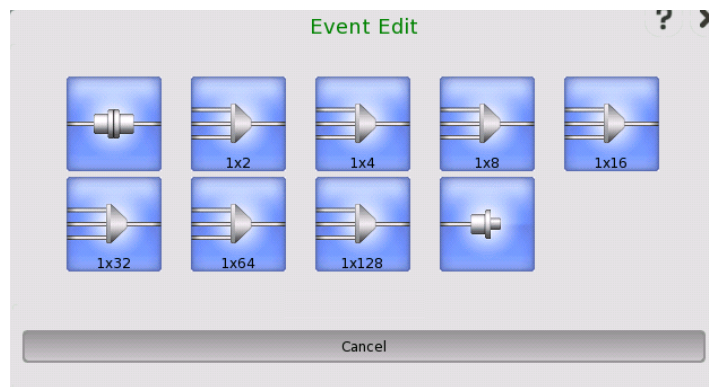

Touching the icon changes the Event icon.
Touching **Cancel** button does not change the Event icon.



Start icon and End icon cannot be edited.

Soft keys

Test Mode

Touching this button switches the Test Mode between **Auto** and **Manual**. When setting to **Manual**, the measurement parameters can be set.

Wavelength

Touching this button switches the wavelength applied for the test.

Parameters

Touching this button launches the Test Parameter dialog box which allows to set **Distance Range**, **Pulse Width**, **Resolution**, and **Average Time**. This button is enabled when Test Mode is set to **Manual**.

Overlay

Swap Overlay: Opens the dialog box selecting the trace to swap.

VFL

Allows users to switch visible light output. When selecting **On** or **Blink**, the red icon will blink at the bottom left of the screen.





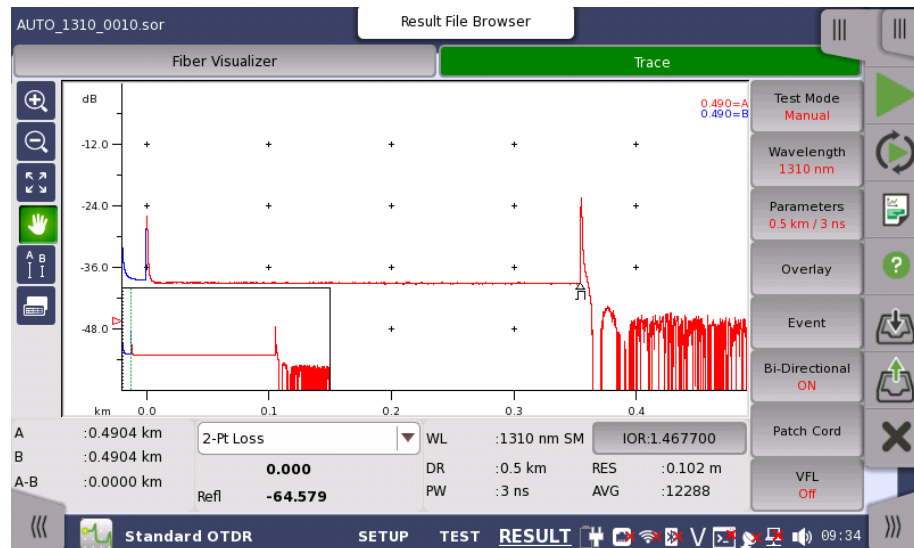

VFL appears if Option 002 is installed.

5.1.3.3 Trace

Touching the **Trace** button in the navigation area will launch the following screen.



In the Trace screen, the fiber loss versus distance is shown in graphical. The following icons appear on the traces.

-  Appears at an event position with [Event type](#) icon.
-  This icon appears on the left hand axis, at the level of the active cursor.
-  Appears at the position of an LSA (Least Squares Approximation) cursor.
-  Appears if Launch fiber in [Fiber](#) screen is set to other than **None**. This position is the start point of the fiber under test.
-  Appears if Receive fiber in [Fiber](#) screen is set to other than **None**. This position is the end point of the fiber under test.

Icons on the left hand control the screen display.



When this icon is green, dragging an area on the trace window allows users to zoom the trace.



When this icon is green, touching a point on the trace window allows users to zoom out the trace.



Touching this icon shows the trace in full range.



When this icon is green, touching the trace window allows users to drag the trace.





Touching this icon displays the buttons moving a cursor and **A**, **B**, **Utility** buttons under the trace window.

LSA1 to **LSA4** buttons appear when selecting **Splice Loss**, **2-pt LSA**, or **dB/km LSA**.

To select a cursor, touch a button of the cursor or touch **Cursor A** or **Cursor B** on the screen.

To move a cursor:

- Touch  or .
- Touch a point on the trace which is the destination of the cursor.



Touching this icon displays the [event table](#).

The following items appear under the trace window.

Cursor

A: Distance of Cursor A

B: Distance of Cursor B

A-B: Distance between Cursor A and Cursor B

Loss Mode

Selects a loss mode by touching the field.

When the loss mode is set to **ORL**, **Calc** button appears.

For details of loss mode, refer to [Loss Modes](#) section.

Measurement Setup

WL: Wavelength, SM (Single mode fiber) or MM (Multi mode fiber)

DR: Distance range

PW: Pulse width

IOR: Index of reflection

RES: Resolution

AVG: Average times

Utility

Provides the cursor behavior setting and functions using a cursor.

- **Default LSA**: Moves LSA cursors to default positions. Enabled when LSA cursors are displayed.
- **Cursors**:
 - Selecting **Locked** will lock the distance between cursor A and cursor B.
 - Selecting **Unlocked** allows setting distance of cursor A and cursor B separately.
- **Adjust IOR by Cursor A**: Adjusts IOR by setting the actual distance of cursor A.
 1. Move cursor A to the event which the distance is known.
 2. Touch **Utility**.
 3. Touch the **Adjust IOR by Cursor A** field.

4. Set the actual distance of cursor A by using a keypad.
5. Touch **OK**, then IOR will be adjusted so that actual distance of cursor A is displayed.

Event Table

When the touching the  button in the Trace screen, Event Table appears in the Trace screen.

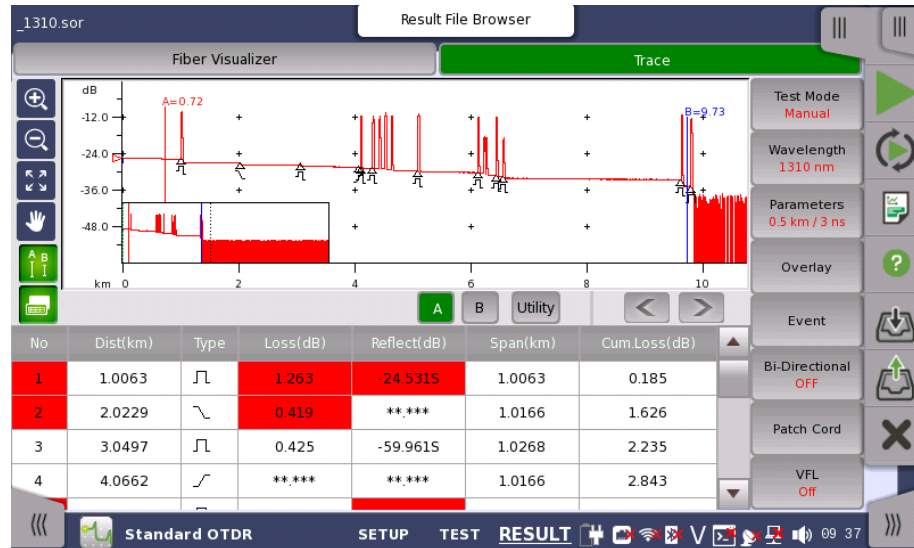









Detected events on the trace are displayed in the table.

- **No**: The event number.
- **Dist**: Distance of the event.
- **Type**: Event type shown by an icon.
- **Loss(dB)**: Loss of the event.
- **Reflect(dB)**: Reflectance at the event.
- **dB/km**: Fiber loss from the previous event.
- **Span**: Distance from the previous event. For the first event, the distance from Launch fiber.
- **Cum.Loss(dB)**: The cumulative loss which is the difference from the level at the origin.

dB/km or **Span (km)** appears depending on **Event Table Span Calculation** setting in [Analysis](#) tab of Preferences screen.

Event Types

| | |
|---|---|
|  | <p>Reflective Event Reflection from a splice point, such as a Fresnel reflection caused by a mechanical splice or connector.</p> |
|  | <p>Non-Reflective Event Non-reflective events include such low loss events as fusion splices and Macro Bends.</p> |
|  | <p>Grouped Event Events spaced too close to each other for Analysis to distinguish them as separate events are reported as Grouped events.</p> |
|  | <p>Far End Event Any event with a loss equal to or greater than the Fiber End threshold in Auto Detect screen is reported as the Far End event.</p> |
|  | <p>Questionable Event The last event is set to Questionable Event in the following case:</p> <ul style="list-style-type: none"> • When the fiber length is longer than Distance Range • When Far End event is not found |
|  | <p>Splitter Event All events other than far end events with losses greater than the far end threshold are displayed as Splitter events.</p> |
|  | <p>Launch Event Launch Event appears at Launch fiber position. Does not appear if Launch Fiber is set to None on Fiber screen.</p> |
|  | <p>Receive Event Receive Event appears at Launch fiber position. Does not appear if Receive Fiber is set to None on Fiber screen.</p> |

Add Event

Before adding the new event, set Cursor A as the active (red) cursor and position it at the location for the new event.

1. Touch the Loss Mode field and select **Splice Loss**.
2. Touch the **Event** soft key.
3. Touching the **Add Event** will open the following dialog box.

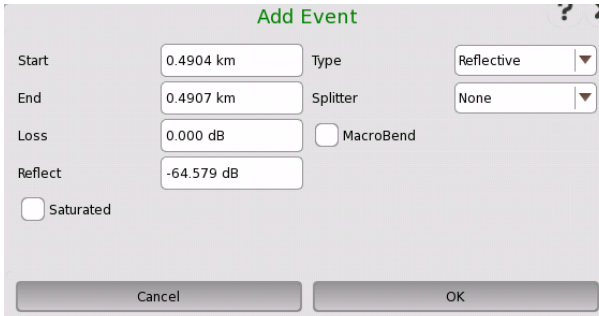

Start

Touch the Start field and then use the Numeric keypad to enter the desired starting point for the new event.

End

Touch the End field and then use the Numeric keypad to enter the desired end point for the new event.

Loss

Touch the Loss (dB) field and then use the Numeric keypad to enter the desired loss for the new event.

Reflect

Touch Reflect field and then use the Numeric keypad to enter the desired reflectance value for the new event.

Saturated

If selecting the check box, the new event will be flagged with an "S" after its Reflectance value in the Event table to denote it as a saturated event.



An event which has been added to a trace is flagged with an "" before its event number in the Event table to signify that it was manually added.*

*The original trace and event table can be retrieved as long as you have not saved the edited trace. Touch **Event** soft key and touch **Analyze** to re-run the analysis. The trace and its Event table are returned to their original status.*

Type

Touch the Type field and then select the desired event type:
Non-Reflective, **Reflective** or **Group**.

If selecting Non-Reflective event, **Reflect** and **Saturated** are disabled.

Splitter

Touch Splitter field and then select the desired number of splits of the new event.

MacroBend

Select the check box if add as a MacroBend event.

Edit Event

Before editing the new event, set Cursor A as the active (red) cursor and position it at the location for the new event.

1. Touch the Measurement Mode field and select **Splice Loss**.
2. Touch the **Event** soft key.
3. Touching the **Edit Event** will open the following dialog box.

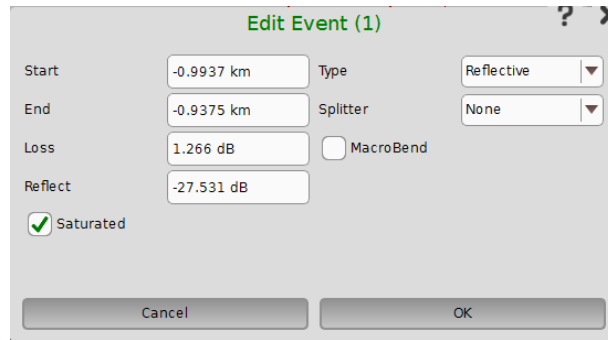

If selecting Non-Reflective event, **Reflect** and **Saturated** are disabled.

If selecting Far End event or Questionable event, **Splitter** and **MacroBend** are disabled.

Start

Touch the Start field and then use the Numeric keypad to enter the new starting point for the selected event.

End

Touch the End field and then use the Numeric keypad to enter the new end point for the selected event.

Loss

Touch the Loss (dB) field and then use the Numeric keypad to enter the new event loss for the selected event.

Reflect

Touch Reflect field and then use the Numeric keypad to enter the new reflection value for the selected event.

Saturated

If selecting the check box, the selected event will be flagged with an "S" after its Reflectance value in the Event table to denote it as a saturated event.



An event that has been moved is flagged with an "" before its event number in the Event table.*

*The original trace and event table can be retrieved as long as you have not saved the edited trace. Touch **Event** soft key and touch **Analyze** to re-run the analysis. The trace and its Event table are returned to their original status.*

Type

Touch the Type field and then select the new event type:

| Event type | Available types |
|-----------------------------------|-----------------------------------|
| Non-Reflective, Reflective, Group | Non-Reflective, Reflective, Group |
| Far End, Questionable | Far End |



Editing Questionable event will change type to Far End.

Splitter

Touch Splitter field and then select the new number of splits of the selected event. If selecting other than **None**, the event type will be set to Splitter in spite of **Type** setting.

MacroBend

Select an event check box for new MacroBend.

Soft keys

Test Mode

Touching this button switches the Test Mode between **Auto** and **Manual**.

Wavelength

Touching this button selects the wavelength applied for the test.

Parameters

Touching this button launches the Test Parameter dialog box which allows to set **Distance Range**, **Pulse Width**, **Resolution**, and **Average Time**. This button is enabled when Test Mode is set to **Manual**.

Overlay

This key is available if overlay traces are loaded.

- **Drop Overlay:** Launches the dialog box selecting the trace to drop.
- **Swap Overlay:** Launches the dialog box selecting the trace to swap.
- **Align Overlay:** Selects how to align overlay traces.
 - **OFF:** Does not align Overlay traces.
 - **1dB Offset:** Aligns Overlay traces with 1 dB spacing.
 - **ON:** Forces all Overlay traces to align at the intersection of the currently active cursor and the Primary trace.
- **Show Overlay:** Turns the overlay trace display on or off.

Event

- **Analyze:** Starts the event analysis.
- **Add Event:** Launches [Add Event](#) dialog box.
- **Edit Event:** Launches [Edit Event](#) dialog box.
- **Delete Event:** Deletes the event.

Bi-Directional

This key is available when the overlay trace is loaded. If setting to **On**, the selected overlay trace is displayed in reversed direction.



The Bi-directional analysis is available when the following two traces are displayed.

- *Overlay trace measured from the opposite end of the fiber*
- *Primary trace measuring the same fiber.*

When Bi-Directional is set to **ON**, the following analysis values are calculated from both traces and the event analysis results will be updated.

- Total Loss
- Loss (dB)
- dB/km
- Cum.Loss (dB)

To define the range to detect the same event on the Overlay trace as the event on the Primary trace, specify **Bi-Directional Correlation** value on [Analysis](#) tab of the Preferences screen.

Patch Cord

- **Active Cursor to Launch:** Sets the active cursor position to Launch Length of Patch-cord Setup.
- **Active Cursor to Receive:** Sets the active cursor position to Receive Length of Patch-cord Setup.

VFL

Allows users to switch visible light output. When selecting **On** or **Blink**, the red icon will blink at the bottom left of the screen.



VFL appears if Option 002 is installed.

5.1.3.4 Power Meter

To measure the optical power, touch the tab at right-top to expand [Application Toolbar](#).

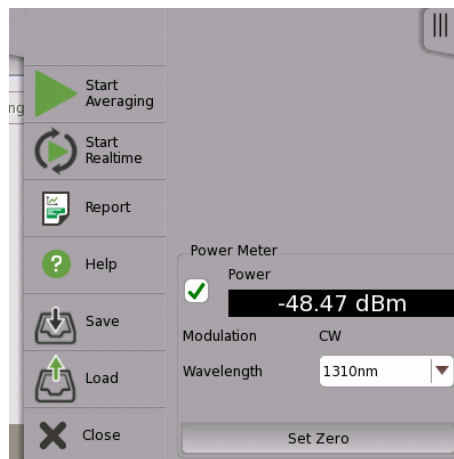

1. Select the check box.
2. Select a wavelength.
3. When inputting the light to the OPM connector, the measured power value appears.

Zero Offset

Zero offset performs the 0-level calibration of the power meter. Performing zero offset will reduce measurement errors when the input power level is low.

1. Disconnect the fiber (if connected) and close the OPM port cover.
2. Touch **Set Zero**.
3. The confirmation message appears. Touch **OK**.
The message disappears when the zero offset process is completed

5.1.4 Measurements

5.1.4.1 Distance Measurement

When a primary trace is displayed, the fiber distance is automatically measured from the origin of the trace to each of the two cursors (A, B) and between the cursors (A-B). The values are displayed at left-hand bottom of the Trace screen. Proper cursor placement is crucial for accurate measurements.





Improper distance readings may be reported if the Index of Refraction (IOR) is set inaccurately.

Two of the most common distance measurements are:

- [Fiber Length](#) (the total distance of a fiber)
- [Distance to a Break](#) (the distance from a known point to a break in the fiber)

Fiber Length Measurement

1. Touch .
2. Touch .
3. Touch **A**.
4. Place Cursor A at the end of the test fiber box (pulse suppressor), if one is used, or at 0.0000 km, as shown in the following figure.

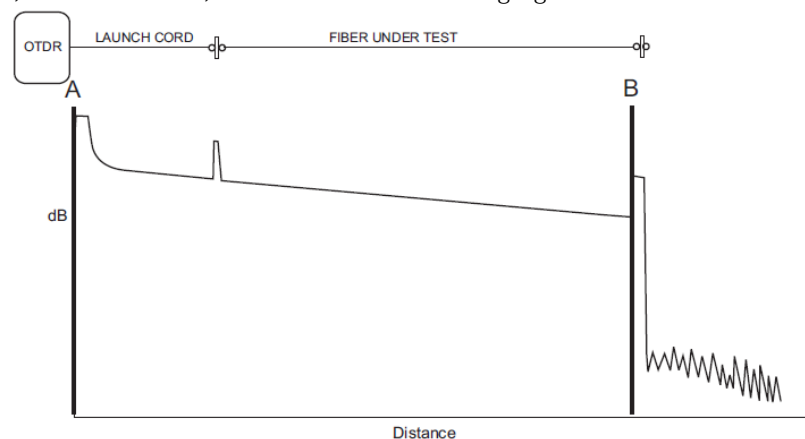

5. Touch  to expand the screen horizontally and vertically around Cursor A for more accurate cursor placement.
6. Place Cursor A on linear backscatter just prior (to the left side) of the reflective or non-reflective event, as shown in the following figure.

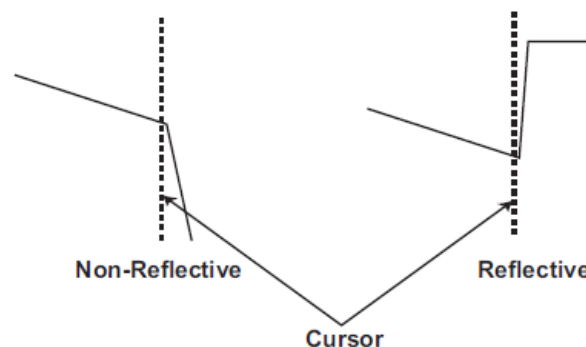



7. Touch **B**.
8. Place Cursor B at the end of the fiber (see figure in step 4).

9. Expand the screen horizontally and vertically around Cursor B for more accurate cursor placement.
10. Place Cursor B on linear backscatter just prior (to the left side) of the reflective or non-reflective event (see figure in step 6).
11. Read the fiber length as the A-B distance in the Cursor Distance information area.

Distance to a Break Measurement

The following procedure demonstrates a method of locating a break relative to a known point on the fiber.

1. Touch .
2. Touch .
3. Touch **B**.
4. Place Cursor B at the break in the fiber, as shown in the following figure.

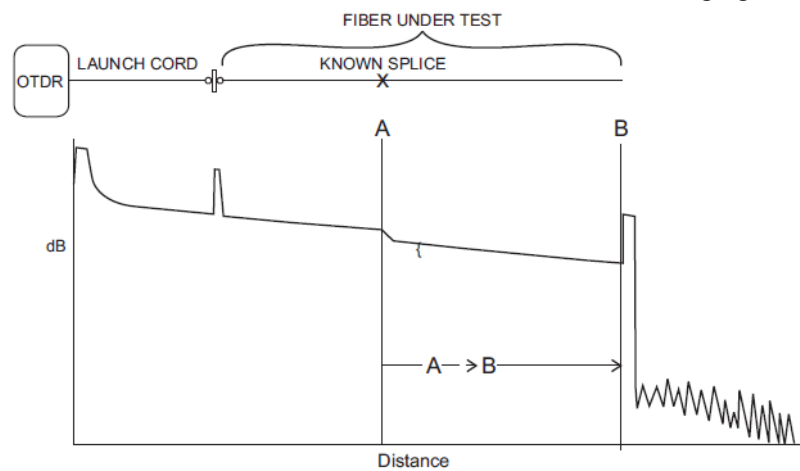

5. Touch  to expand the screen horizontally and vertically around Cursor B for more accurate cursor placement.
6. Place Cursor B on linear backscatter just prior (to the left side) of the reflective or non-reflective event, as shown in the following figure.

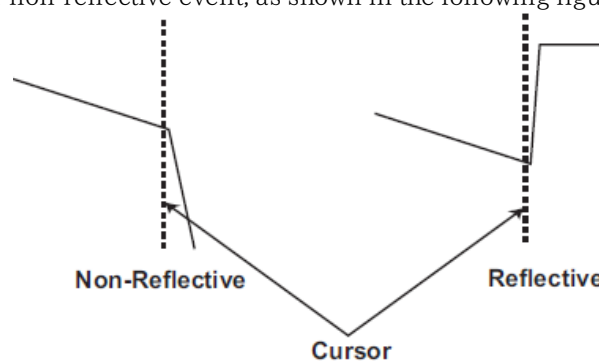

7. Touch **A**.
8. Place Cursor A at a known point on the fiber (see figure in step 4).
9. Expand the screen horizontally and vertically around Cursor A for more accurate cursor placement.
10. Place Cursor A on linear backscatter just prior (to the left side) of the reflective or non-reflective event (see figure in step 6).
11. Read the distance from the known point to the break as the A-B distance in the Cursor Distance information area.

5.1.4.2 Loss Measurements

Loss Modes

When a primary trace is displayed, there are several different types of measurements available through the Loss Mode field:

- [Splice Loss](#)
- [2-Pt Loss](#)
- [2-Pt LSA](#)
- [dB/km Loss](#)
- [dB/km LSA](#)
- [2-Pt & dB/km Loss](#)
- [ORL \(Optical Return Loss\)](#)

Event Examples

The following figure shows examples of events on a fiber that are referred to in the various Loss Mode procedures that follow this section. Use the figure as an aid to understand some of the terminology used to describe measurement procedures.

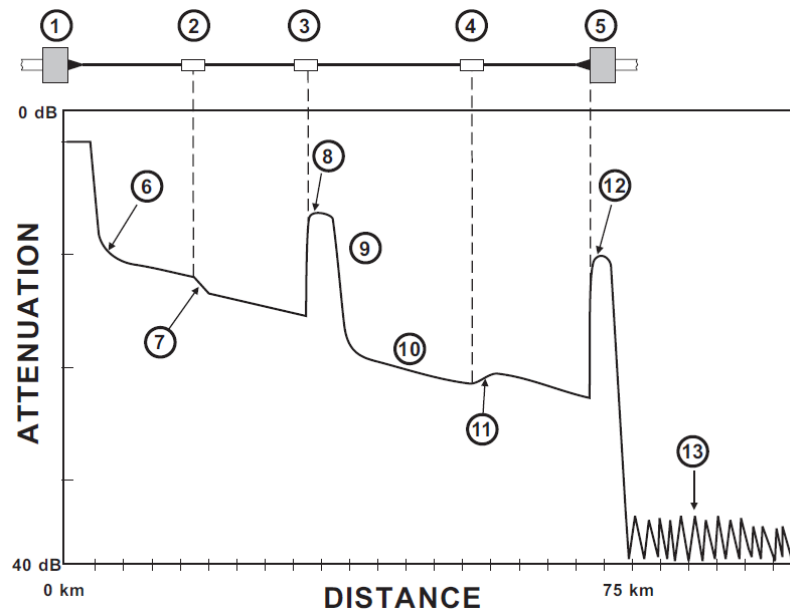

| | | | |
|---|-----------------------------|----|-----------------------------|
| 1 | OTDR input | 8 | Reflective splice connector |
| 2 | Fusion splice | 9 | Fresnel reflection |
| 3 | Mechanical splice connector | 10 | Rayleigh backscatter |
| 4 | Fusion splice | 11 | Non-reflective gainer |
| 5 | End of cable | 12 | Reflective end |
| 6 | Diffusion tail | 13 | Noise floor |
| 7 | Non-reflective loser | | |

2-Point Loss

The 2-Point Loss Measurement uses a data point at Cursor A and a data point at Cursor B to calculate the change in dB between the two points. Normally the Cursor A (Y-Axis) data is greater than the Cursor B (Y-Axis) data and a positive loss measurement is displayed. Otherwise, the loss value is reported as a negative quantity called a "gainer".

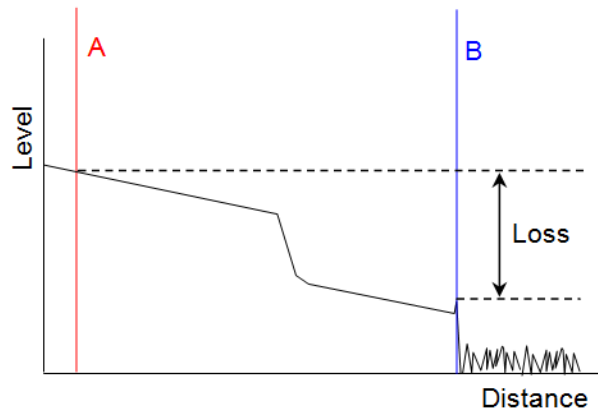

dB/km Loss

The dB/km Loss measurement uses a data point at Cursor A and a data point at Cursor B to calculate the change in dB (Y-Axis) between the two points. This is divided by the distance between the two Cursors to calculate the Loss/Distance measurement. When Cursor A (Y-Axis) data is greater than Cursor B (Y-Axis) data, a positive loss measurement is displayed.

$$\text{Loss/Distance (dB/km)} = \frac{\text{2-Point Loss}}{\text{Distance between Cursor A and Cursor B}}$$

Splice Loss

Use Splice Loss mode to measure the optical power loss caused by connectors, splices, and couplers on a fiber optic cable.

Use the following figure in conjunction with the splice loss procedure to measure splice loss:

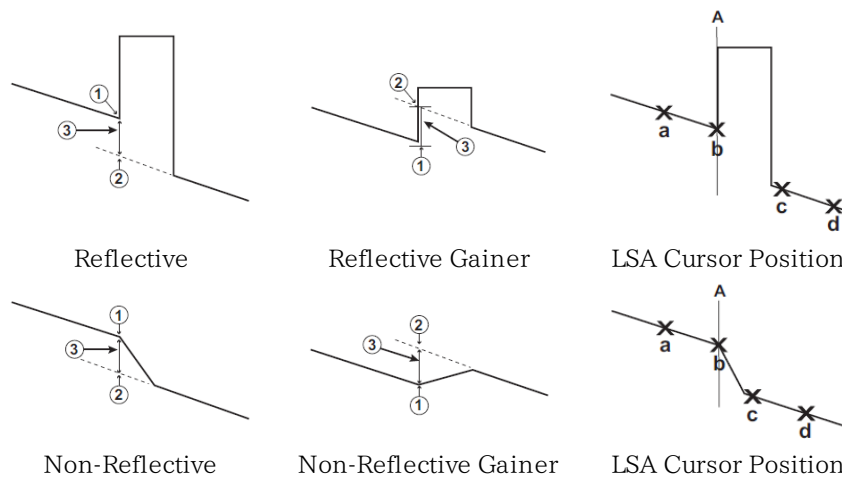

① Start of Splice

② Y-Intercept

③ Splice Loss (The Splice Loss is equal to the Y-axis position at ① less the Y-axis position at ②.)

Cursor A should be placed at the start of the splice. The Y-Axis position (①) at the start of the splice will be determined by an LSA calculation using the interval set up to the left of Cursor A. The Y-Intercept point (②) is determined by an LSA calculation using the current data interval setup to the right of Cursor A, and calculating the intercept back to Cursor A.

Adjusting the LSA Intervals for Splice Loss Mode

On some events you may need to adjust the LSA intervals (fuzzy cursors) to obtain a better estimate of an event splice loss, especially if either of the intervals fall within the actual loss interval or "knee" (see the following figure).

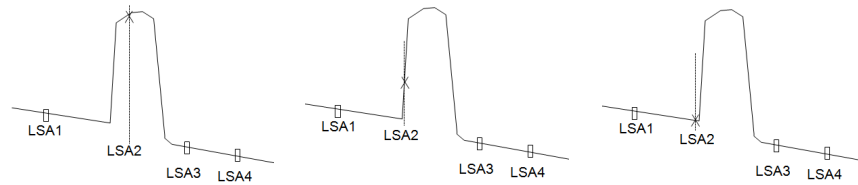

The intervals fall within the actual loss interval

The intervals fall within the knee

The appropriate interval

2-Point LSA

The Least Squares Approximation (LSA) 2-Point Loss measurement uses an LSA technique to calculate the best Y-intercept values based on the current cursor positions. Intervals directly to the right of Cursor A and left of Cursor B will be used to calculate the intercept values. The length of the LSA intervals is user selectable. The default value is approximately 400 meters. The ends of the intervals are displayed as "X" marks, as shown in the following figure.

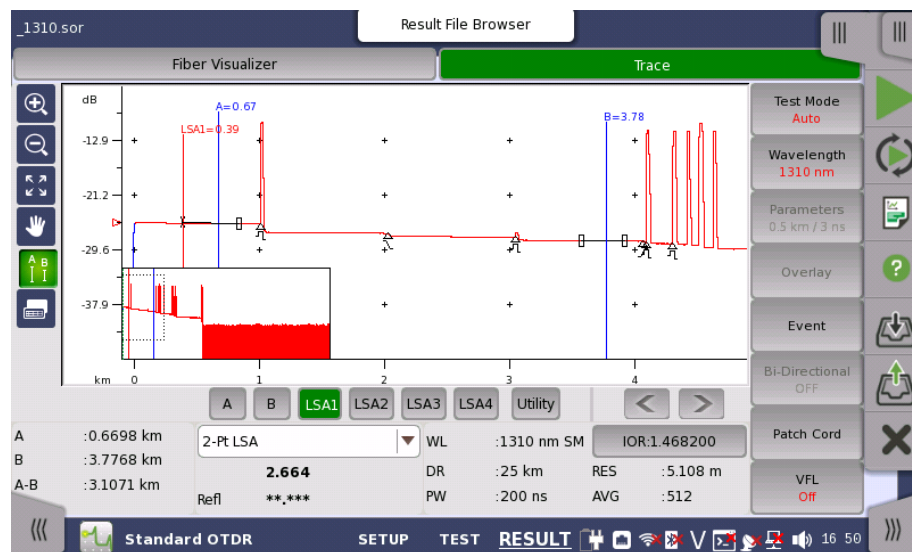

The LSA 2-Point Loss is the change in dB (Y-Axis) calculated between the two points. When the Cursor A, Y-Axis position is greater than the Cursor B, Y-Axis position, a positive loss measurement is displayed.

LSA technique is useful when the trace is excessively noisy.

The left interval is associated with Cursor A and the right interval with Cursor B. The default location for the left interval is immediately to the right of Cursor A. The default location for the right interval is immediately to the left of the B Cursor.

Adjusting the Left and Right LSA Intervals

In some cases, such as a very noisy trace or a trace with closely spaced event, you may need to adjust the LSA intervals (fuzzy cursors) to obtain more accurate 2-Point LSA and dB/km LSA loss measurements. Refer to [Adjusting the LSA Intervals for Splice Loss Mode](#).

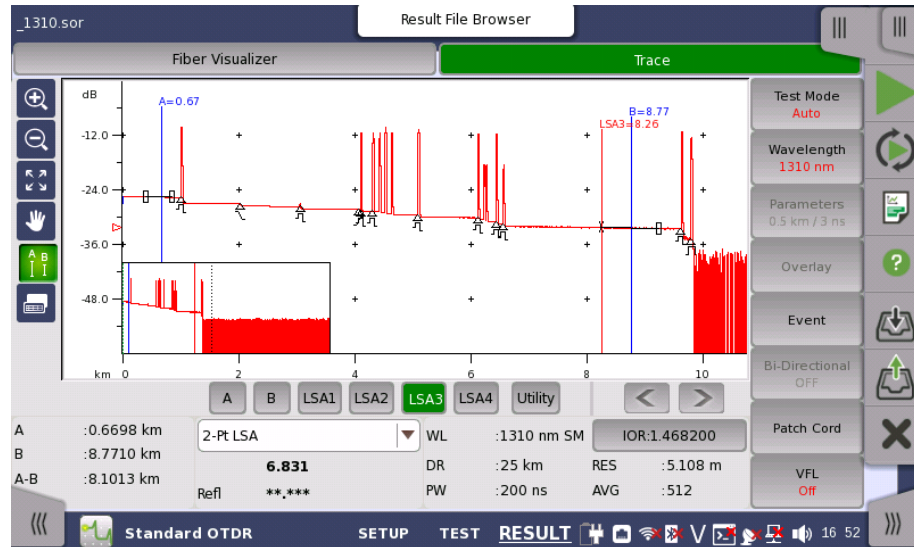

dB/km LSA

The dB/km LSA Loss measurement finds the LSA 2-Point Loss (refer to [2-Point LSA](#) for details) and divides it by the distance between the two cursors.

$$\text{Loss/Distance (dB/km)} = \frac{\text{LSA 2-Point Loss}}{\text{Distance between Cursor A and Cursor B}}$$

ORL (Optical Return Loss)

The Network Master provides the ability to calculate Optical Return Loss (ORL), the ratio of reflected energy to input energy for a fiber optic link.

ORL can be calculated for a section of the fiber optic link or for the entire link.

2-point & dB/km Loss

The combined 2-Point & dB/km loss mode displays both loss values at the same time. The loss values, separated by a "," are displayed in the Loss Mode, Measurement, and Reflectance area.

Refer to [2-Point Loss](#) and [dB/km Loss](#) for details on the individual loss modes.

5.1.4.3 Reflectance

Overview

Reflectance is the ratio of reflected power to incident power displayed in dB. A reflectance measurement is affected by the Pulse width and the Backscatter Coefficient.

A reflectance value for reflective events is displayed in the lower section of the Loss Mode, Measurement, and Reflectance area when either Auto or Manual is selected by the Reflectance Calculation on Analysis tab in Preferences screen. The reflectance reading may also contain an "S" indicator. The reflectance measurement is made relative to Cursor A when set to Auto and relative to Cursors A and B when set to Manual.

Auto Reflectance Mode

Auto Reflectance mode requires placement of Cursor A only and automatically makes the measurement based upon the cursor placement. There are restrictions on the placement of Cursor A detailed in the following procedure.



When the reflectance value is saturated, the value will be preceded by an "S".

To perform auto reflectance measurements:

1. Touch **SETUP** at the bottom of the screen.
2. Touch **Preference** in the navigation area and touch **Analysis**
3. Touch **Reflectance Calculation** field and select **Auto**.
4. Touch **Measurement** in the navigation area.
5. Touch **Test Mode** field and select **Manual**.
 - Set the **Distance Range**, selecting the shortest possible range, following the fiber length plus 25% rule.
 - Set the **Pulse width**. $1 \mu s$ is a good typical setting. This setting generally provides a combination of good range and good resolution.
 - Set the **Resolution** to **Fine**.
 - Set the **Average Time** to **1min**, to provide good data acquisition.
6. Touch **Start Averaging** icon in application toolbar to test the fiber.

After the test is completed, the reflectance reading is displayed in the lower section of the Loss Mode, Measurement, and Reflectance area. Moving Cursor A will change the reflectance value.
7. Place Cursor A on backscatter just prior (to the left side) of the reflective event in order to achieve an accurate reflectance measurement.

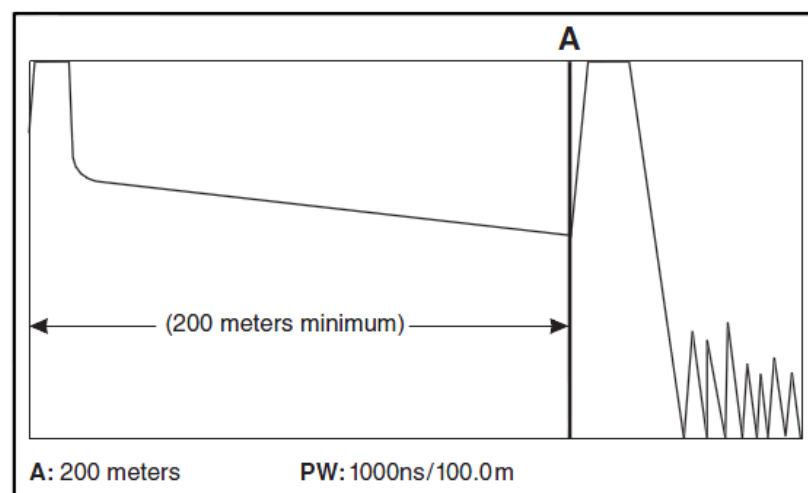

- Zoom in on the trace to place Cursor A as close as possible to the rising edge of the reflection. Cursor A must be placed on a linear section of the waveform backscatter and NOT the rising edge of the reflection. (See the figure in step 7 which uses a $1 \mu\text{s}$ pulse width and yields a 200 meter minimum distance between origin and Cursor A placement.)
Cursor A may be placed to within two pulse widths from the origin or start of the OTDR trace (OTDR bulkhead).

Manual Reflectance Mode

Both Cursors (A and B) are used for this measurement.

To perform auto reflectance measurements:

- Touch **SETUP** at the bottom of the screen.
- Touch **Preference** in the navigation area and touch **Analysis**.
- Touch **Reflectance Calculation** field and select **Manual**.
- Touch **Measurement** in the navigation area.
- Touch **Test Mode** field and select **Manual**.
 - Set the **Distance Range**, selecting the shortest possible range, following the fiber length plus 25% rule.
 - Set the **Pulse width**. $1 \mu\text{s}$ is a good typical setting. This setting generally provides a combination of good range and good resolution.
 - Set the **Resolution** to **Fine**.
 - Set the **Average Time** to **1min**, to provide good data acquisition.
- Touch **Start Averaging** icon in application toolbar to test the fiber.
After the test is completed, the reflectance reading is displayed in the lower section of the Loss Mode, Measurement, and Reflectance area. Moving Cursor A will change the reflectance value.
- Place Cursor A on backscatter just prior (to the left side) of the reflective event in order to achieve an accurate reflectance measurement.

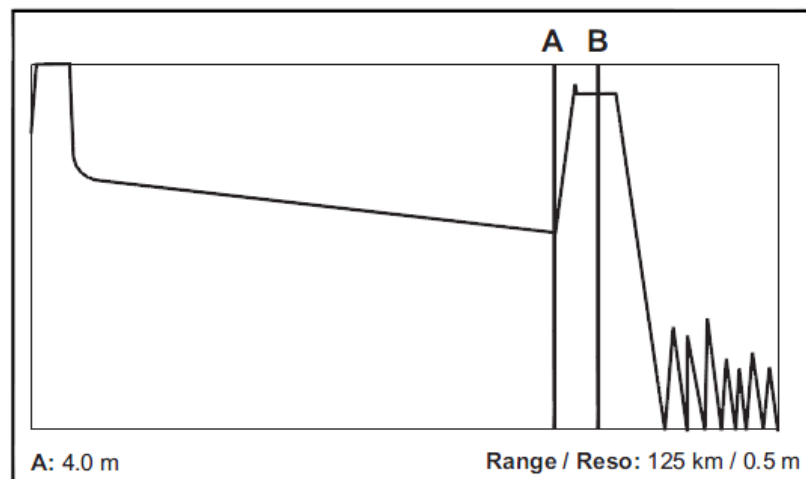

- Zoom in on the trace to place Cursor A as close as possible to the rising edge of the reflection. Cursor A must be placed on a linear section of the waveform backscatter and NOT the rising edge of the reflection (See the figure in step 7).
- Place Cursor B on the center of the reflectance pulse (see the figure in step 7).



Occasionally a small, narrow peak may be present (as shown in the figure above). Do not place Cursor B on top of the first narrow peak, if a narrow peak is present, as this will result in an inaccurate reflectance measurement.

5.1.4.4 Real Time Testing

Real Time test mode provides a quick 'real-time' view of the initial trace information. In this mode, trace data is not continually averaged, but is stopped and restarted after each screen update. Real Time mode enables optimization of fiber connections at or near the OTDR connector, as the trace display shows the effect of the making changes to the connections.



To attenuate a saturated event when in Real Time test mode, move the active cursor within the event, until the unit auto-attenuates the event (pulling the event out of saturation).

5.2 FTTA



Fiber To The Antenna (FTTA) is the technology connecting the base stations of mobile communication system using the optical fiber. FTFA application is designed for locating fault positions of an optical fiber installed in base stations.

- Optimize the measurement parameters such as distance range, for short distance optical fiber test.
- The test result is displayed on Fiber Visualizer and Trace screen. However, number of analysis parameters to set are decreased.

5.2.1 Measurement Condition Setup

The first step in running an application is to set up the port interfaces. This is done on the **Setup** screen, which also provides port status information.

For following settings, refer to the sections in Standard OTDR application.

- [Port](#)
- [Measurement](#)
Only Wavelength can be set on Measurement screen.
- [IOR/BSC](#)
- [Header](#)
- [Preferences](#)

5.2.2 Test Setup

For screen description, refer to sections in Standard OTDR application.

- [Fiber](#)
- [Auto Detect](#)
- [Pass/Fail](#)



*In FTFA application, settings concerning the splitter do not appear.
Number of parameters to set has been reduced than that of Standard OTDR application.*

5.2.3 Test Result

5.2.3.1 Fiber Visualizer

Touching the **Fiber Visualizer** button in the navigation area will launch the following screen.

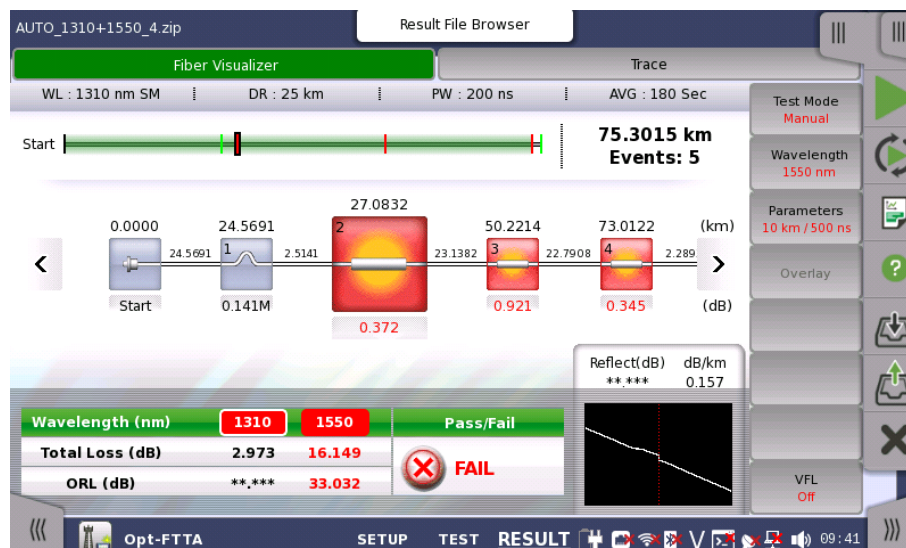

For screen description, refer to [Fiber Visualizer](#) section in Standard OTDR application.

Soft keys

Test Mode

Touching this button switches the Test Mode between **Auto** and **Manual**. When setting to **Manual**, the measurement parameters can be set.

Wavelength

Touching this button switches the wavelength applied for the test.

Parameters

Touching this button launches the Test Parameter dialog box which allows to set **Distance Range**, **Pulse Width**, **Resolution**, and **Average Time**. This button is enabled when Test Mode is set to **Manual**.

Overlay

This key is available if overlay traces are loaded.

- **Swap Overlay:** Opens the dialog box selecting the trace to swap.

VFL

Allows users to switch visible light output. When selecting **On** or **Blink**, the red icon will blink at the bottom left of the screen.



VFL appears if Option 002 is installed.

5.2.3.2 Trace

Touching the **Trace** button in the navigation area will launch the following screen.

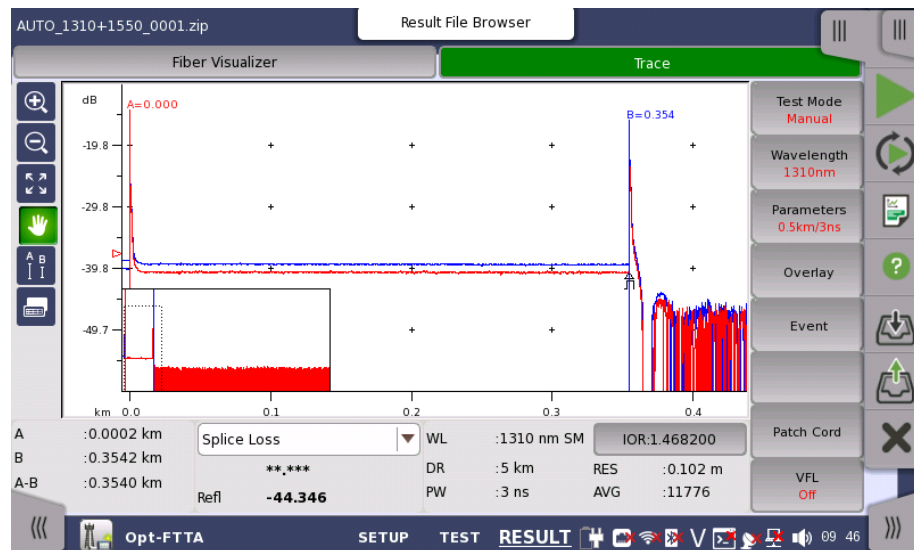

For screen description, refer to [Trace](#) section in Standard OTDR application.

Soft keys

Test Mode

Touching this button switches the Test Mode between **Auto** and **Manual**.

Wavelength

Touching this button selects the wavelength applied for the test.

Parameters

Touching this button launches the Test Parameter dialog box which allows to set **Distance Range**, **Pulse Width**, **Resolution**, and **Average Time**. This button is enabled when Test Mode is set to **Manual**.

Overlay

This key is available if overlay traces are loaded.

- **Drop Overlay:** Launches the dialog box selecting the trace to drop.
- **Swap Overlay:** Launches the dialog box selecting the trace to swap.
- **Align Overlay:** Switches how to align overlay traces.
 - **OFF:** Does not align Overlay traces.
 - **1dB Offset:** Aligns Overlay traces with 1 dB spacing.
 - **ON:** Forces all Overlay traces to align at the intersection of the currently active cursor and the Primary trace.
- **Show Overlay:** Turns the overlay trace display on or off.

Event

- **Analyze:** Starts the event analysis.
- **Add Event:** Launches [Add Event](#) dialog box.
- **Edit Event:** Launches [Edit Event](#) dialog box.
- **Delete Event:** Deletes the event.

Patch Cord

- **Active Cursor to Launch:** Sets the active cursor position to Launch Length of Patch-cord Setup.
- **Active Cursor to Receive:** Sets the active cursor position to Receive Length of Patch-cord Setup.

VFL

Allows users to switch visible light output. When selecting **On** or **Blink**, the red icon will blink at the bottom left of the screen.



VFL appears if Option 002 is installed.

5.2.3.3 Power Meter

To measure the optical power, touch the tab at right-top to expand [Application Toolbar](#).

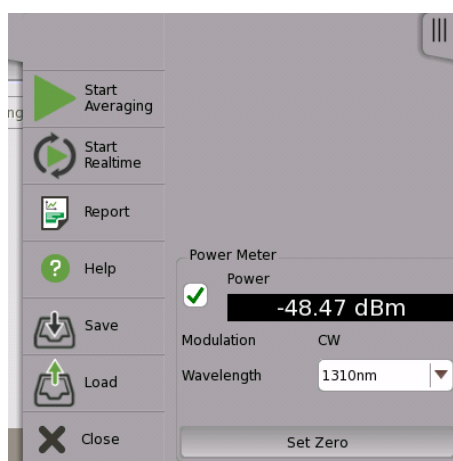

1. Select the check box.
2. Select a wavelength.
3. When inputting the light to the OPM connector, the measured power value appears.

Zero Offset

Zero offset performs the 0-level calibration of the power meter. Performing zero offset will reduce measurement errors when the input power level is low.

1. Disconnect the fiber (if connected) and close the OPM port cover.
2. Touch **Set Zero**.
3. The confirmation message appears. Touch **OK**.
The message disappears when the zero offset process is completed

5.3 Construction



An optical cable contains many optical fibers. So testing those fibers is required when installing the optical cables. Construction is the application which is designed to test multiple fibers sequentially.

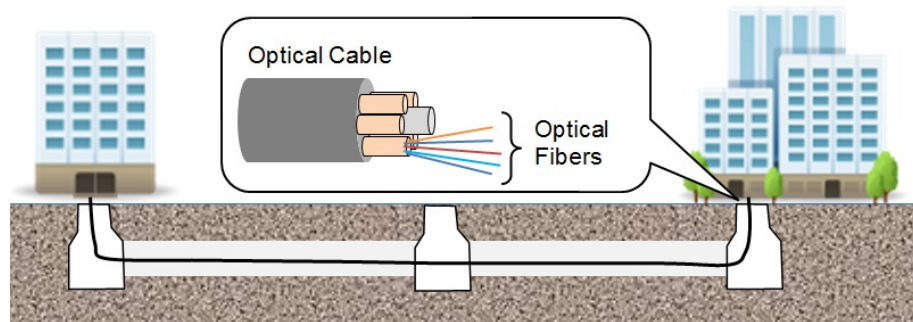

Example of Underground Optical Cable Installation

In Construction application, set Number of Fibers in the **Project** screen. Construction measurement repeats the fiber measurement in count set in the Number of Fibre. It is allowed to skip a fiber measurement on the way of Construction measurement. Measurement Condition Setup and Test Setup are locked while the Construction measurement is running.

5.3.1 Application Toolbar

Some icons on Application Toolbar are changed in Construction application.

Start Test



Touching the **Start Test** icon starts the test defined in Project. After the measurement of all fibers has completed, the traces are deleted automatically and the Setup screen is displayed.

Cancel All Test



Touching the **Cancel All Test** icon cancels the measurement defined by the project.

Skip This Test



This icon is available while the measurement is running. Touching the **Skip This Test** icon skips one test of the fiber number under measurement without saving the measurement results.

Accept



To use this icon, set Preview softkey to **ON** during the fiber measurement. This icon will be available after one fiber measurement in the project has finished. Touch the **Accept** icon to save the measured fiber test result. The project resumes the next fiber measurement.

5.3.2 Measurement Condition Setup

The first step in running an application is to set up the measurement conditions. This is done on the **Setup** screen, which also provides port status information.

5.3.2.1 Project

Touching the **Project** button in the navigation area will launch the following screen.

The screenshot displays the 'Project' setup screen within the 'Opt-Construction' application. The screen is titled 'Application Selector' and features a navigation bar with tabs: 'Project' (selected), 'Measurement', 'Template', 'IOR/BSC', 'Header', and 'Preferences'. The main area contains the following fields and values:

- Project Name:** Route_001
- Number of Fibers:** 1
- Start Fiber Number:** 1
- Location A:** tokyo
- Location B:** yokohama
- Direction:** A->B
- Store Files At:** Internal/
- Base Filename:** *Location*_Wavelength*_Number*

At the bottom, the folder path is shown as ':Internal/Route_001/' and the file name as ':tokyo_yokohama_1310_0001.sor'. The bottom status bar includes the application name 'Opt-Construction', the current screen 'SETUP', and other navigation options like 'TEST' and 'RESULT'.

Project Name

Touch the field to enter the project name.

Number of Fibers

Touch the field and set the number of fibers which will be tested.

Start Fiber Number

Touch the field and set the start fiber number. When **Number of Fibers** is 20 and **Start Fiber Number** is 5, the fiber numbers to be measured will be set to 5 through 24

Location A

Sets the location name at measurement start.

Location B

Sets the location name at measurement end.

Direction

Selects a direction to be measured.

A -> B: Location A to Location B

B -> A: Location B to Location A

Store Files At

Sets the destination folder to save files.

The folder name where the file will be saved actually is displayed at the bottom of the Setup area.

Base Filename

The Base Filename field provides a template for use when generating an auto-filename. You can enter the base filename of up to 70 characters.

The folder path and the filename to save first are displayed at the bottom of the Setup area.

5.3.2.2 Measurement

Touching the **Measurement** button in the navigation area displays two tabs.

Wavelength

Touching the **Wavelength** tab will launch the following screen.

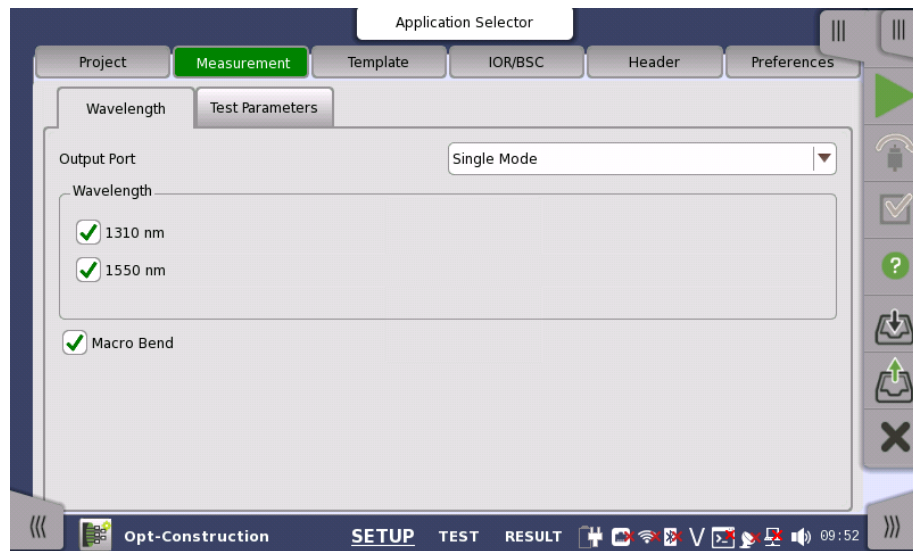

Output Port

Touch the field to select the port used for the test.

- MU100020A, MU100022A: Fixed to **Single Mode**.
- MU100021A: **Single Mode, Multi Mode**

Wavelength

Select the checkbox of the wavelength used for the test.

| Output Port | Available wavelength |
|-------------|---------------------------|
| Single Mode | 1310 nm, 1550 nm, 1625 nm |
| Multi Mode | 850 nm, 1300 nm |



Available wavelength depends on the model.

Macro Bend

Appears when **Output Port** is set to Single Mode. Selecting the check box will run the macro bend analysis from the measurement results.

Test Parameters

Touching the **Test Parameters** tab will launch the following screen.

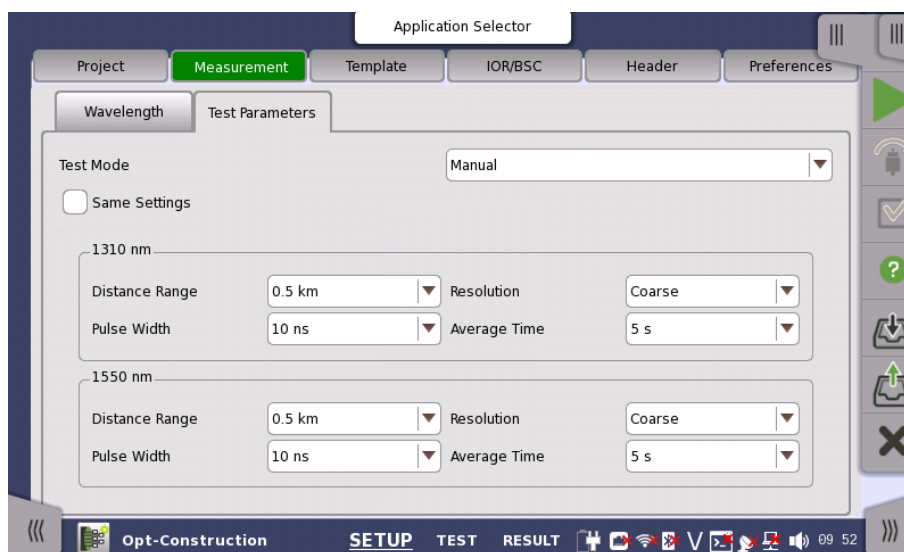

Same Settings

Select the check box if applying the same settings for all wavelengths.

The following items can be set for each wavelength.

Test Mode

Touch the field to select the test mode.

If selecting **Auto**, the parameters will be set automatically.

Selecting **Manual** allows a user to set parameters.

Distance Range

Select the upper limit of distance to locate faults.

Pulse Width

Select the pulse width of optical signal.

Resolution

Select the resolution in horizontal.

Average Time

Select the averaging time of measured traces applied for **Start Averaging**.

5.3.2.3 Template

Touching the **Template** button in the navigation area will launch the following screen.

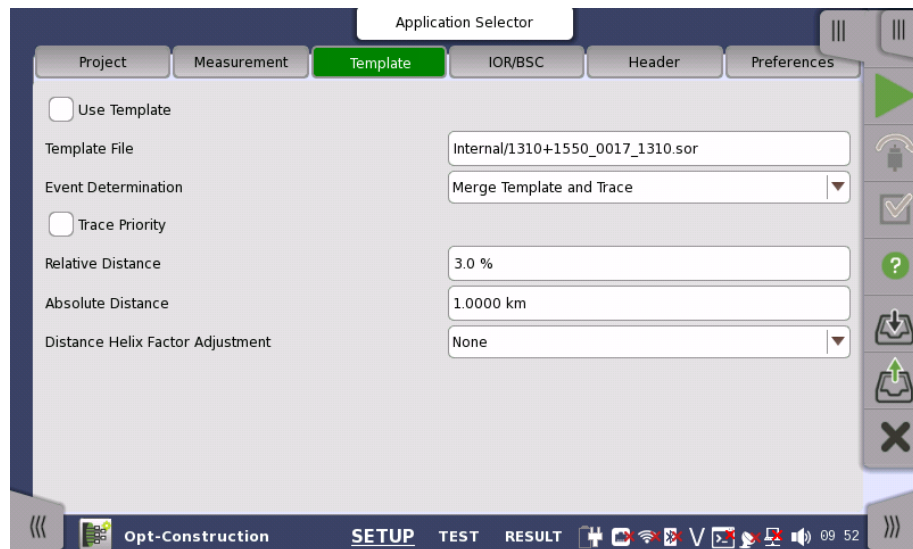

Use Template

To use template, select the check box.

Template mode is a function to display event information by generating a predefined event table and mapping the collected trace onto the event conditions in this event table.

The reflectance events or the loss events are likely to appear at the same points in each measured trace, because the fibers installed in the same cable are connected and bended at the same distances. Therefore the event analysis is performed at the same distances by using the pre-defined trace (template).

Template File

Touch the field and select the template file.

Event Determination

The setting made in the Event Determination controls how the Template trace event are applied to the selected target trace.

- **Copy from Template:** all events are copied directly from the template trace and onto the collected trace.
- **Merge Template and Trace:** the events in the template trace and the collected trace are correlated and merged.
Both the collected trace and the template trace are analyzed.

Trace Priority

The Trace Priority check box gives the target trace event location priority over correlated events from the template when Merge is selected.

If cleared, events are processed as the following.

- Non-correlated template events are inserted into the target trace.
- Correlated template events replace the correlating target trace events.
- All other target trace events are left unchanged.

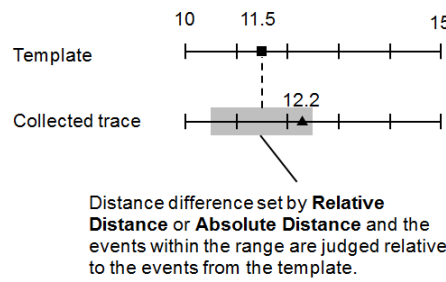

In the left example, if the checkbox is not selected, the event distance from the collected trace (12.2 km) is replaced by that from the template (11.5 km).

If the checkbox is selected, the event distance from the collected trace (12.2 km) is used as it is.

Relative Distance

The Distance defines the size of the correlation window in percentage ratio which determines how close together events must be to correlate.

Absolute Distance

Absolute Distance defines the size of the correlation window in km unit which determines how close together events must be to correlate.

The minimum value of Relative Distance and Absolute Distance is applied to the correlation window.

Example

When Relative Distance is 3 % and Absolute Distance is 1 km are set:

| Event Distance | Relative Distance | Absolute Distance | Correlation Window |
|----------------|-------------------|-------------------|--------------------|
| 10 km | 0.3 km | 1 km | 0.3 km |
| 50 km | 1.5 km | 1 km | 1 km |

Distance Helix Factor Adjustment

Events in the template trace and the target trace may not align perfectly due to the differences in lengths of the fibers within a single cable. Distance Helix Factor Adjust options compensate for the difference in length and also obtain improved splice location and loss estimation.

- **None:** The template and target trace event locations will be used as they are, without Distance Helix Factor Adjustment.
- **Snap to Template End:** All event distances of measured trace will be converted by the following formula so that the far end distance of measured trace will match the far event distance of the template.

$$E'_{Mes}(i) = E_{Mes}(i) \times \frac{D_{Temp}}{D_{Mes}}$$

$E_{Mes}(i)$: The i-th event distance of the measured trace.

$E'_{Mes}(i)$: The i-th event distance after the conversion.

D_{Temp} : Far End event distance of the template.

D_{Mes} : Far End event distance of the measured trace.

- **Snap to Trace End:** All template event distances will be converted by the following formula so that the far end distance of template will match the far event distance of measured trace.

$$E'_{Temp}(i) = E_{Temp}(i) \times \frac{D_{Mes}}{D_{Temp}}$$

$E_{Temp}(i)$: The i-th event distance of the template.

$E'_{Temp}(i)$: The i-th event distance after the conversion.

D_{Temp} : Far End event distance of the template.

D_{Mes} : Far End event distance of the measured trace.

When the following conditions are assumed, the result event distances are shown in the table.

Event distances of the template (km): 10, 20, 40

Event distances of the measured trace (km): 20.1, 30.1, 40.1

Relative Distance: 3.0 %

Absolute Distance: 1.0000 km

Setting of Template Screen and Distances of Event Analysis

| Use Template | Event Determination | Distance Helix Factor Adjustment | Trace Priority | Distances of Event Analysis (km) |
|--------------|--------------------------|----------------------------------|----------------|----------------------------------|
| Off | - | - | - | 20.1, 30.1, 40.1 |
| On | Copy from Template | None | - | 10, 20, 40 |
| | | Snap to Template End | - | 10, 20, 40 |
| | | Snap to Trace End | - | 10.025, 20.05, 40.1 |
| | Merge Template and Trace | None | Off | 10, 20, 30.1, 40 |
| | | | | 10, 20, 30.025, 40 |
| | | | | 10.025, 20.05, 30.1, 40.1 |
| | | None | On | 10, 20.1, 30.1, 40.1 |
| | | | | 10, 20.05, 30.025, 40 |
| | | | | 10.025, 20.1, 30.1, 40.1 |

Detailed explanation of the Distance Helix Factor Adjustment function

The following explanation assumes the Template screen settings other than the Distance Helix Factor Adjustment options are as follows.

- Event Determination: Merge
- Trace Priority: OFF
- Distance: 30%
- Absolute Distance: 1 km

Also, assume that the Template trace and Target trace event locations are as follows:

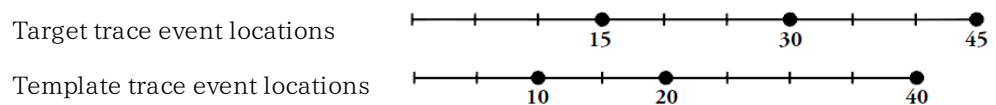

The following describes the corrections performed when each option is selected for the example shown above.

- If **None** is selected

1. The event locations for the Target trace and Template trace events remain unchanged and correlation is performed without using the Distance Helix Factor Adjustment function.

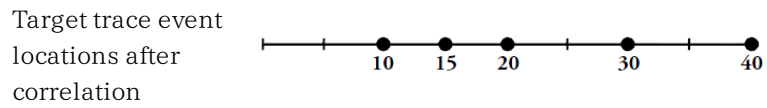

- If **Snap to Template End** is selected

1. Each Template trace event is converted proportionately relative to the Target trace end event location.

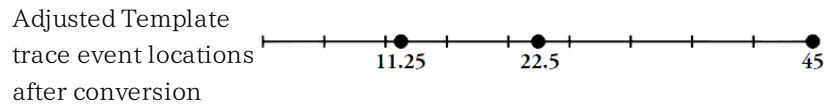

2. Next, correlation is performed using the Target trace events and converted temporary Template trace events.

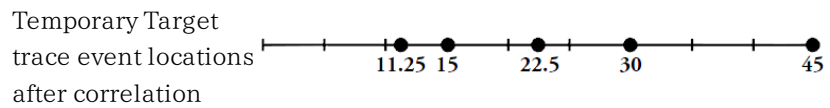

3. Finally, the correlated temporary Template trace events are converted proportionately relative to the end event location for the Template trace events.

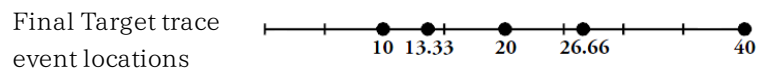

- If **Snap to Trace End** is selected

1. Each Template trace event is converted proportionately relative to the Target trace end event location.

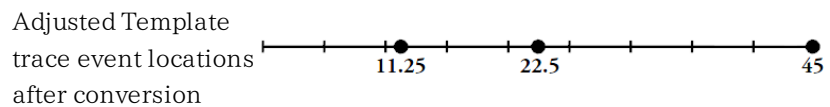

2. Next, correlation is performed using the Target trace events and converted temporary Template trace events.

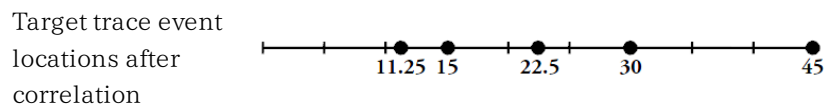

The following table shows examples of resultant target trace events for the three Distance Helix Factor Adjustment options

Resultant Target Trace Events

| Template Trace Event Location | Target Trace Event Location | Result | | |
|-------------------------------|-----------------------------|-----------------------------------|----------------------|-------------------|
| | | Distance Helix Factor Adjustment: | | |
| | | None | Snap to Template End | Snap to Trace End |
| 10 | 15 | 10, 15 | 10, 13.33 | 11.25, 15 |
| 20 | 30 | 20, 30 | 20, 26.66 | 22.5, 30 |
| 40 | 45 | 40 | 40.0 | 45 |

5.3.2.4 IOR/BSC

Touching the **IOR/BSC** button in the navigation area will launch the following screen.

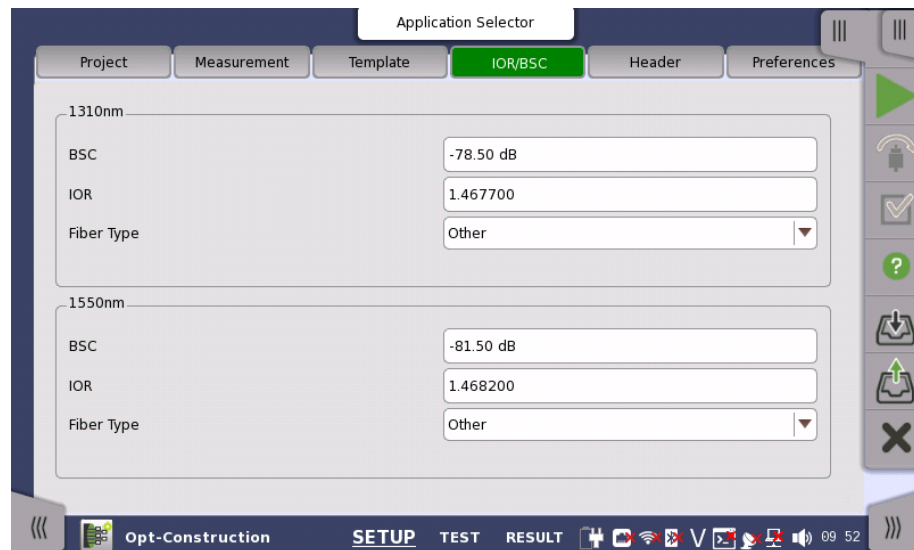

The following items can be set to each wavelength.

BSC

Touch the field to enter BSC.

BSC (Backscatter Coefficient) is the optical power reflection ratio per meter. BSC is used for calculating the optical loss.

IOR

Touch the field to enter IOR.

IOR (Index of Refraction) is used for calculating the distance from time delay of reflected pulse.

Fiber Type

Select the fiber.



*The values set in this screen are applied to the trace measured next time and later. To change IOR and BSC of the following trace, use **IOR** of the Trace screen.*

- Current trace
- Loaded trace from a file

5.3.2.5 Header

Touching the **Header** button in the navigation area will launch the following screen.

| Field | Value |
|-----------------|-----------|
| Data Flag | BC(built) |
| Cable ID | alfa |
| Fiber ID | beta |
| Cable Code | gamma |
| Location A | osaka |
| Location B | tokyo |
| Direction | A->B |
| Operator | aaa |
| Comment | bbb |
| Sequence Number | 10 |

In this screen, the contents of File header which will be stored in the result file (*.sor) can be set.

Next items are printed in [Report](#).

Cable ID, Fiber ID, Location A, Location B, Operator

Data Flag

Selects the data flag of the measured traces

- **BC(built)**: The trace which was measured when the cable was built.
- **RC(repair)**: The trace which was measured when the cable was repaired.
- **OT(other)**: The trace which was measured in other case.

Cable ID

Sets the ID of the measured cable.

Fiber ID

Sets the ID of the measured fiber.

Cable Code

Sets the cable code of the measured cable.

Location A

Sets the location name at measurement start. **Location A** of [Project](#) screen will be changed to the name entered here.

Location B

Sets the location name at measurement end. **Location B** of [Project](#) screen will be changed to the name entered here.

Direction

Selects a direction to be measured. **Direction** of [Project](#) screen will be changed to the direction selected here.

A -> B: Location A to Location B

B -> A: Location B to Location A

Operator

Sets the the measured person's name.

Comment

Sets the comment concerned to the measured trace.

Sequence Number

Sets the starting number of the sequence number included in the header.

5.3.2.6 Preferences

Touching the **Preferences** button in the navigation area will display four tabs.

Measurement

Touching the **Measurement** tab displays the following screen.

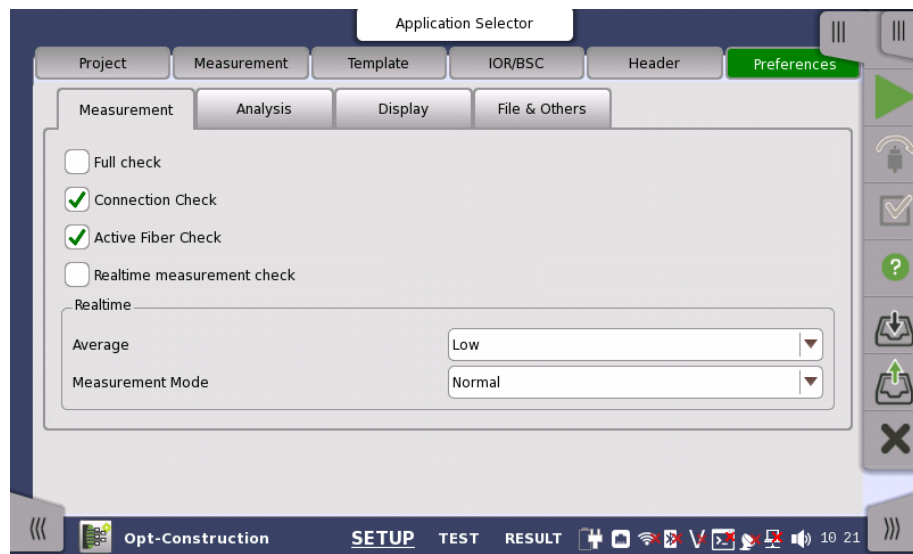

Full check

Selecting the check box selects three check boxes of **Connection Check**, **Active Fiber Check**, and **Realtime measurement check**.

Connection Check

The [Connection Check](#) function confirms whether or not the fiber is connected correctly to the OTDR measurement port.

Active Fiber Check

The Active Fiber Check performs a "live fiber" check on the currently attached fiber under test to detect whether the fiber is carrying traffic before firing any OTDR laser sources.

- If no traffic is detected, the test proceeds normally.
- If traffic is detected, a warning message appears on the screen and the test is aborted.



The Active Fiber Check feature does not apply to the 850/1300 nm multimode fiber.

Realtime measurement check

Selecting the check box runs realtime measurement before performing each fiber test. When multiple wavelengths are selected, the realtime measurement runs using the shortest wavelength.

Average

Select whether processing averaging or not in Realtime Measurement.

- **Low:** Does not perform averaging.
- **High:** Performs averaging. Set this setting when the distance range to measure is long because the OTDR noise can be suppressed.

Measurement Mode

Select whether performing the averaging process or not at Realtime measurement.

- **Normal:** Set when measuring the back scatter light from the optical fiber.
- **High Reflection Measurement:** Set when measuring the trace that large level differences are included such as Fresnel reflections. This setting takes longer measurement time than the **Normal** setting.

Multimode fiber under test

This setting appears when **Multi Mode** is selected on Wavelength tab of Measurement screen. Select the core diameter of the multimode fiber under test. "um" is used in place of " μ m".

Analysis

Touching the **Analysis** tab displays the following screen.

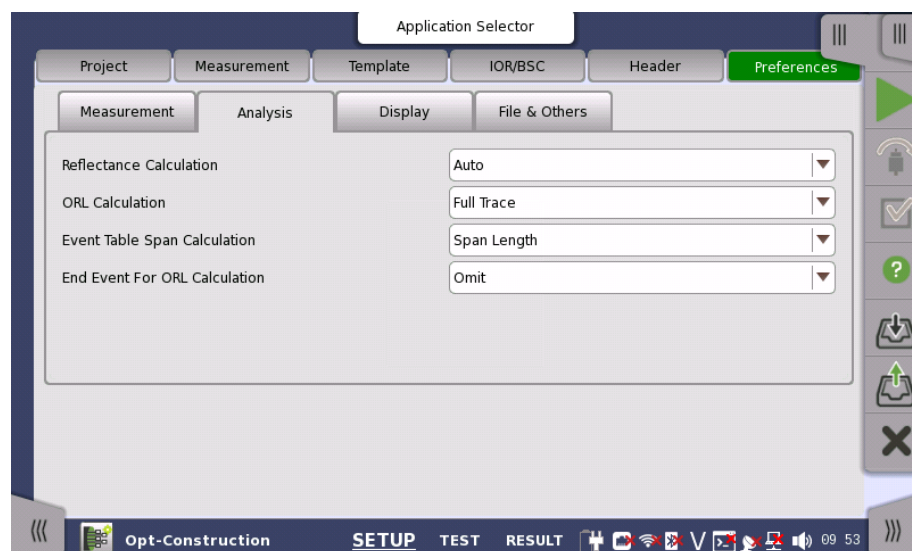

Reflectance Calculation

Select the reflectance calculation method.

- **Off:** Reflectance will not be calculated.
- **Auto:** The reflectance of any event is reported based on the position of cursor A. The Auto setting is most useful for reflective events that are not close together or close-in to the OTDR.
- **Manual:** When set to Manual, the reported reflectance is based on the positions of both cursors (A and B). The Manual setting is most useful for

reflective events that are close together or close-in to the OTDR.

For details, refer to [Reflectance](#).

ORL Calculation

Select the starting point for ORL (Optical Return Loss) measurements.

- **Cursor A:** The ORL measurement is calculated from the cursor A to the cursor B, but the Incident Power is attained from the A cursor position.
- **Origin:** The ORL measurement is calculated from the cursor A to the cursor B, but the Incident Power is attained from the origin (e.g.: 0 km, or Bulkhead connector).
- **Full Trace:** The ORL measurement is calculated from the Origin to the last data point, and the Incident Power is attained from the origin (e.g.: 0 km, or Bulkhead connector).

Event Table Span Calculation

Selects whether to display the span length or transmission loss (dB/km) on event table. This setting function applies only to Event Table in the Trace screen.

- dB/km
- Span Length

End Event For ORL Calculation

Set whether to include reflection in Far-End events or not when calculating the ORL. This setting function applies to the following.

- Include
- Omit

Display

Touching the **Display** tab displays the following screen.

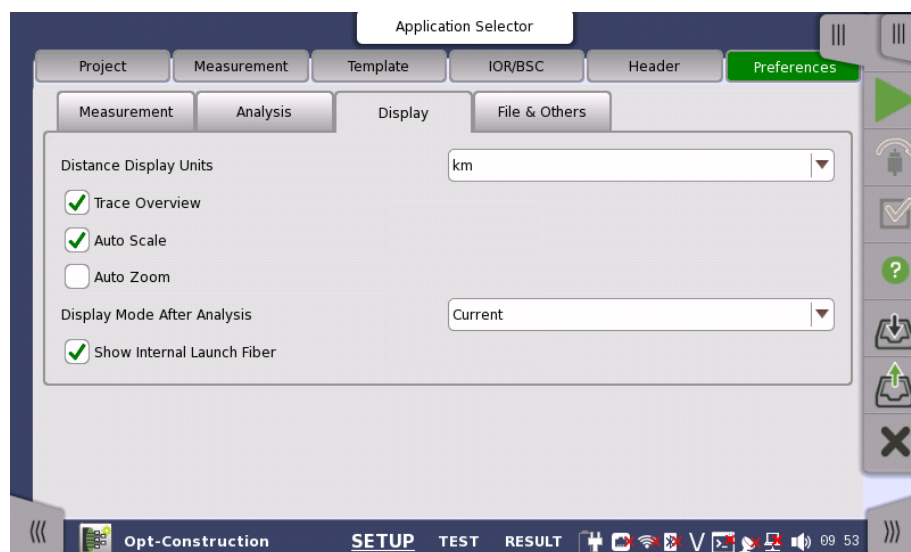

Distance Display Units

Select the unit of measurement used to display distance on the horizontal axis of the Trace graph. This affects Range and Resolution readings and analysis events incorporating distance.

Trace Overview

When the check box is selected, a small overview of the trace is displayed in the lower left portion of the Trace graph.

Auto Scale

When the check box is selected, Horizontal scale is automatically set so that Far End event is displayed in the Trace screen.

Auto Zoom

Selecting the check box will automatically zoom in on the event selected in the Result screen.

Display Mode After Analysis

The Display Mode After Analysis setting is used to set the post-analysis display mode.

- **End/Break:** Displays the range up to the Far end event or the broken point.
- **Full Trace:** Displays full range of distance.
- **Current:** Displays the trace with the current scale settings.

Show Internal Launch Fiber

Selecting the check box will display dummy fiber in the Trace screen.

File & Others

Touching the **File & Others** tab will launch the following screen.

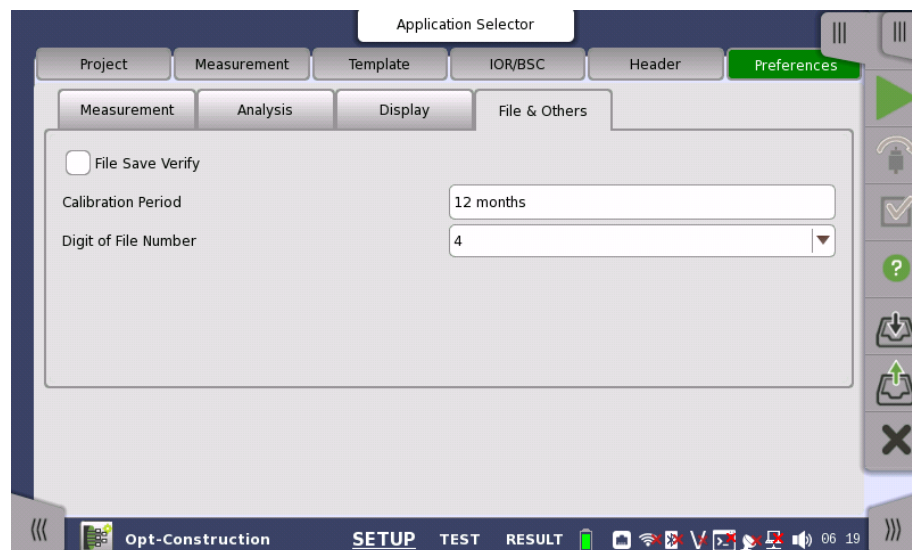

File Save Verify

Selecting the check box displays the file save dialog box when the tests in all specified wavelength have finished.

Calibration Period

Touch the field to set the calibration period in months.



Calibration expiration date is printed in the [Report](#).

Digit of File Number

Select a number of digits of a consecutive number which is add into file names being created during the measurement.

5.3.3 Test Setup

For screen description, refer to sections in Standard OTDR application.

- [Fiber](#)
- [Auto Detect](#)
- [Pass/Fail](#)



In Construction application, settings concerning the splitter do not appear. Number of parameters to set has been reduced to less than that of Standard OTDR application.

5.3.4 Test Result

5.3.4.1 Information

When touching the start icon on the Application toolbar, the **Information** dialog box appears.

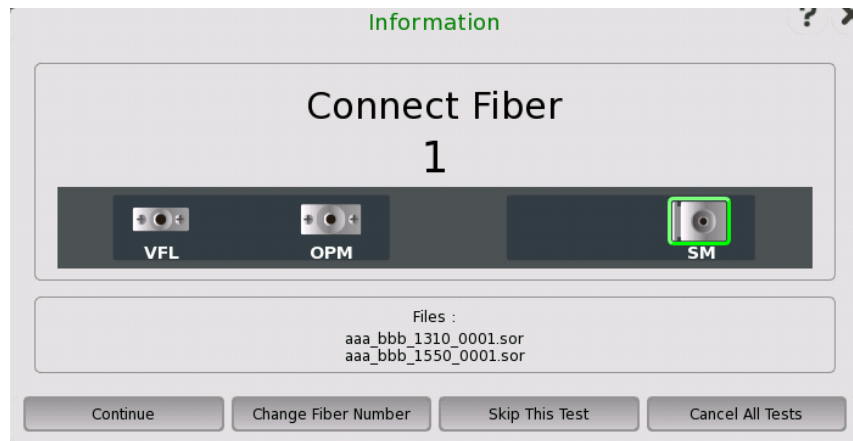

In the upper frame, the fiber number is displayed under **Connect Fiber** and the connecting connector on OTDR module is indicated. In the lower frame, file names which will be stored are displayed.

Continue

Touch **Continue** to advance to the [Connection Check](#) screen, if Connection Check is selected in the [Measurement](#) tab of the Preferences screen.

If Connection Check is cleared in the [Measurement](#) tab of the Preferences screen, touch **Continue** advances to the Trace screen and starts the measurement of the currently connected fiber.

Change Fiber Number

Allows to change the current Connect Fiber number.

Skip This Test

Skips the test of the displayed fiber number. The next fiber number is displayed in the dialog box.

Cancel All Test

Aborts the test of all fibers.

5.3.4.2 Connection Check

If selecting **Connection Check** on Preference screen, Connection Check Level will appear after starting a measurement.

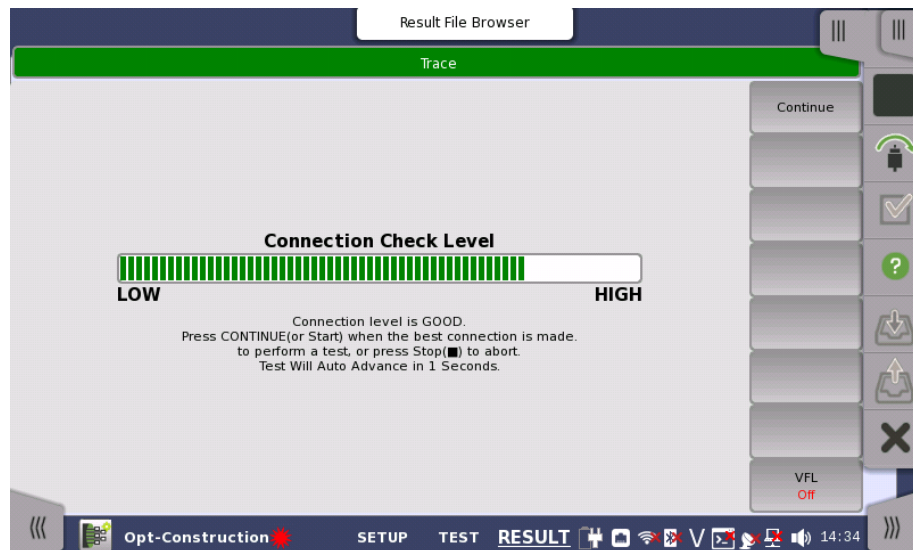

| Bar Color | Connection Loss* |
|-----------|------------------|
| Green | <1 dB |
| Yellow | 1 to 2 dB |
| Red | >2 dB |

*: Values for reference purposes. The value may not be measured correctly depending on reflection from the optical connector or the fiber.

1.5 dB is added to each value when using a 50 μm multi-mode fiber.

Good connection

The gauge is green when connection is good. The closer the bar in the connection gauge extends to "HIGH" end, the better the connection is.

Bad connection

The gauge is red when connection is bad. And it is yellow when connection is not good. If the bar color is yellow, touch **Continue** soft key to perform the test.

If the gauge is yellow or red, the fiber needs cleaning.

If the connection state is not improved even if the fiber is cleaned, the fiber needs to be replaced.





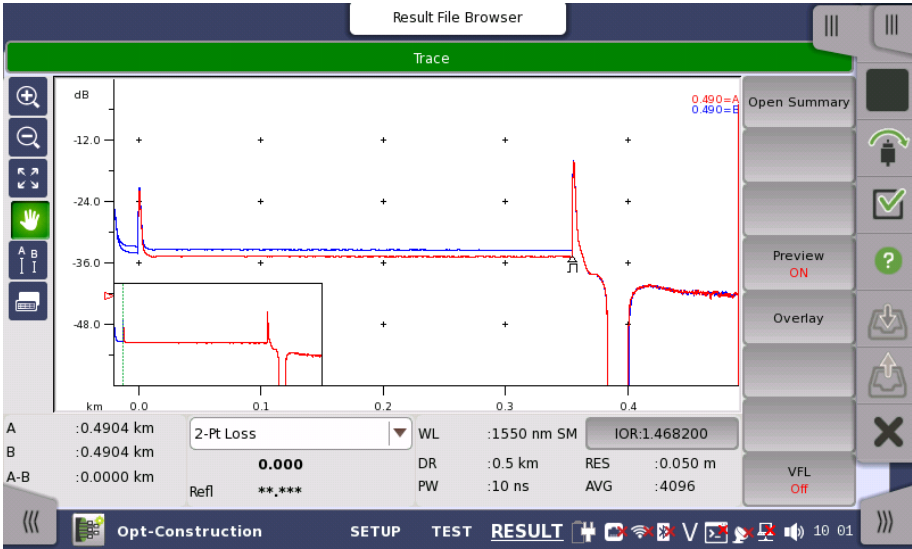

Fibers shorter than approximately 48 meters (160 ft.) will generally result in a low connection level.

5.3.4.3 Trace

The following screen is displayed for test result of Construction application.



In the Trace screen, the fiber loss versus distance is shown in graphical. The following icons appear on the traces.

-  Appears at an event position with [Event type](#) icon.
-  This icon appears on the left hand axis, at the level of the active cursor.
-  Appears at the position of an LSA (Least Squares Approximation) cursor.
-  Appears if Launch fiber in [Fiber](#) screen is set to other than **None**. This position is the start point of the fiber under test.
-  Appears if Receive fiber in [Fiber](#) screen is set to other than **None**. This position is the end point of the fiber under test.

Icons on the left hand control the screen display.



When this icon is green, dragging an area on the trace window allows users to zoom the trace.



When this icon is green, touching a point on the trace window allows users to zoom out the trace.



Touching this icon shows the trace in full range.



When this icon is green, touching the trace window allows users to drag the trace.





Touching this icon displays the buttons moving a cursor and **A**, **B**, **Utility** buttons under the trace window.

LSA1 to **LSA4** buttons appear when selecting **Splice Loss**, **2-pt LSA**, or **dB/km LSA**.

To select a cursor, touch a button of the cursor or touch Cursor A or Cursor B on the screen.

To move a cursor:

- Touch  or .
- Touch a point on the trace which is the destination of the cursor.



Touching this icon displays the [event table](#).

The following items appear under the trace window.

Cursor

A: Distance of Cursor A

B: Distance of Cursor B

A-B: Distance between Cursor A and Cursor B

Loss Mode

Selects a loss mode by touching the field.

When the loss mode is set to **ORL**, **Calc** button appears.

For details of loss mode, refer to [Loss Modes](#) section.

Measurement Setup

WL: Wavelength, SM (Single mode fiber) or MM (Multi mode fiber)

DR: Distance range

PW: Pulse width

IOR: Index of reflection

RES: Resolution

AVG: Average times

Utility

Provides the cursor behavior setting and functions using a cursor.

- **Default LSA**: Moves LSA cursors to default positions. Enabled when LSA cursors are displayed.
- **Cursors**:
 - Selecting **Locked** will lock the distance between cursor A and cursor B.
 - Selecting **Unlocked** allows setting distance of cursor A and cursor B separately.
- **Adjust IOR by Cursor A**: Adjusts IOR by setting the actual distance of cursor A.
 1. Move cursor A to the event which the distance is known.
 2. Touch **Utility**.

3. Touch the **Adjust IOR by Cursor A** field.
4. Set the actual distance of cursor A by using a keypad.
5. Touch **OK**, then IOR will be adjusted so that actual distance of cursor A is displayed.



Soft keys

Open Summary

Touching this button opens the **Summary** dialog box.

Preview

This button is available when averaging measurement is running.

- **Off**: After the averaging measurement has finished, saves the trace data to the file. After the file saving has finished, traces on the window are erased. Then next measurement starts automatically.
- **On**: After the averaging measurement has finished, touch  or  on the application toolbar to start the next test.

Overlay

This key is available if overlay traces are loaded.

- **Swap Overlay**: Launches the dialog box selecting the trace to swap.
- **Show Overlay**: Turns the overlay trace display on or off.

VFL

Allows users to switch visible light output. When selecting **On** or **Blink**, the red icon will blink at the bottom left of the screen.



VFL appears if Option 002 is installed.

5.3.4.4 Summary View

When Preview is set to **ON**, the **Summary** dialog box appears after a fiber measurement of the project has finished.

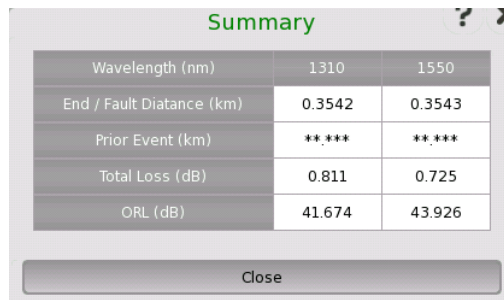

| Wavelength (nm) | 1310 | 1550 |
|---------------------------|--------|--------|
| End / Fault Distance (km) | 0.3542 | 0.3543 |
| Prior Event (km) | **.** | **.** |
| Total Loss (dB) | 0.811 | 0.725 |
| ORL (dB) | 41.674 | 43.926 |

Close

The following items for each wavelength are displayed in the Summary dialog box.

- **End / Fault Distance (km)**: Distance of End event or Fault event.
- **Prior Event (km)**: Distance to the prior event of End event.
If End event is not found, **.** is displayed.
- **Total Loss (dB)**: Total loss of the fiber under measurement.
- **ORL (dB)**: Optical return loss of the fiber under measurement.

5.3.4.5 Power Meter

To measure the optical power, touch the tab at right-top to expand [Application Toolbar](#).

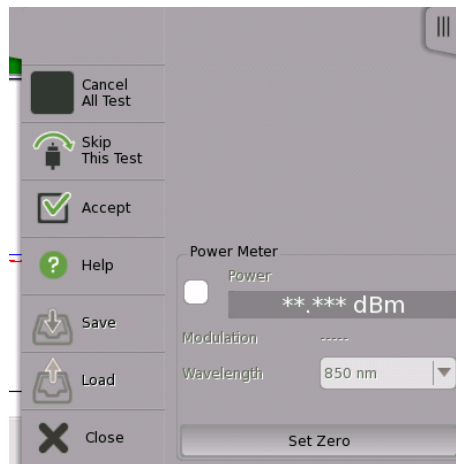

1. Select the check box.
2. Select a wavelength.
3. When inputting the light to the OPM connector, the measured power value appears.

Zero Offset

Zero offset performs the 0-level calibration of the power meter. Performing zero offset will reduce measurement errors when the input power level is low.

1. Disconnect the fiber (if connected) and close the OPM port cover.
2. Touch **Set Zero**.
3. The confirmation message appears. Touch **OK**.
The message disappears when the zero offset process is completed

5.4 OLTS



Optical Loss Test Set (OLTS) applications allows users to measure an optical fiber loss. The optical power and the optical loss are displayed as the test results.

To measure an optical loss:

1. Connect the light source (OTDR/OLS) and OPM via adaptor. Confirm that fiber type and the core diameter are appropriate.

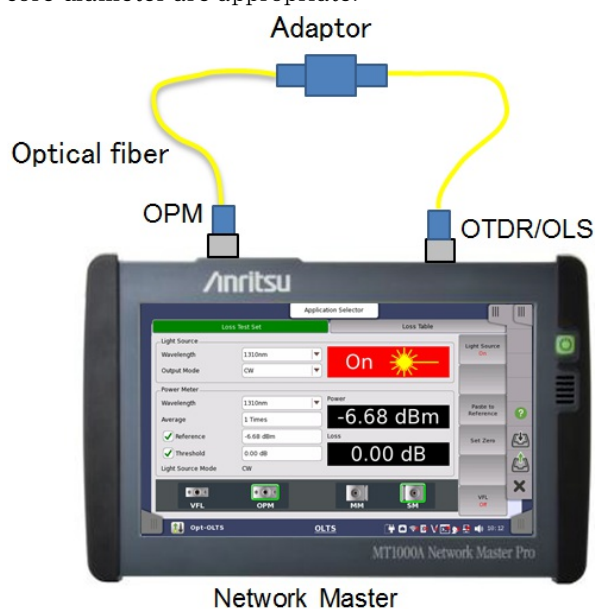

2. Measure the optical power of the light source.
3. Set measured value to **Reference**.
4. Connect the light source (OTDR/OLS) and DUT (device under the test).
5. Connect DUT and OPM. The optical power passed through DUT is measured.

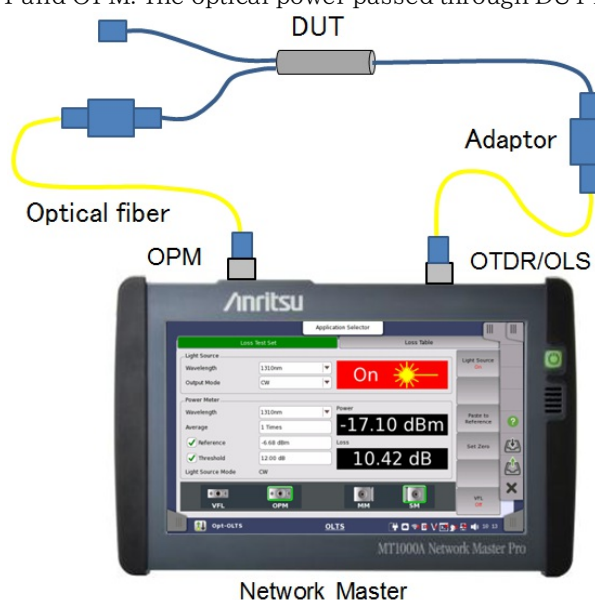

Loss is displayed as the differential between the reference and the measured power.

To measure an optical loss by using two Network Masters:

When a reference of the power meter cannot be measured directly, touch the Reference field and input a power value.

In the transmitter side Network Master, setting the Output Mode of Light Source to **Wave Code** sends the wavelength and its power meter reference modulating output light. The receiver side Network Master sets the detected wavelength and the reference value to itself automatically and displays the loss.

1. Set Output Mode in Light Source of Network Master 1 to **CW**.
2. Measure reference values of Network Master 1 for all wavelengths. Refer to step 1 to 3 in "To measure an optical loss" for details.
3. Connect Network Master 1 Light Source (OTDR/OLS) and Network Master 2 OPM to both ends of DUT.

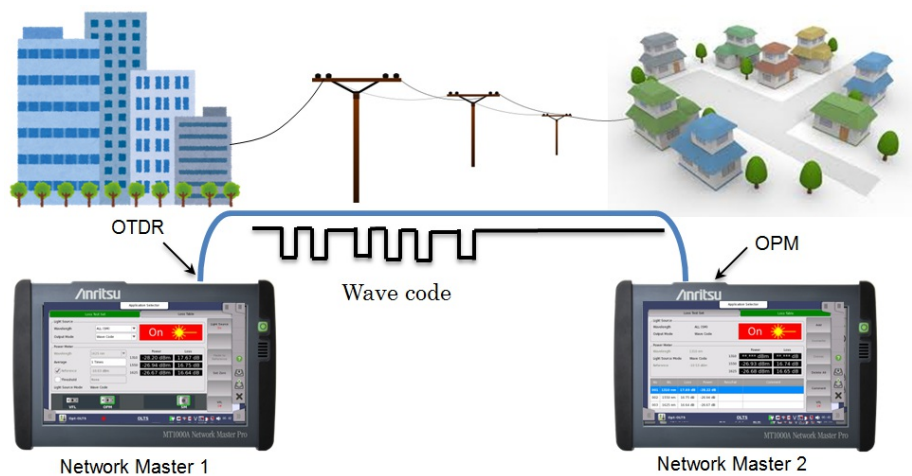

4. Set Network Master 1 Light Source as the following:
Wavelength: **All (SM)**
Output Mode: **Wave Code**
5. Set Network Master 1 Light Source to **On**.
6. Network Master 2 detects wavelengths and reference values received from Network Master 1. Wavelength of the power meter is set automatically and a loss is displayed.

5.4.1 Loss Test Setup

Touching **Loss Test Set** in navigation area displays the following screen.

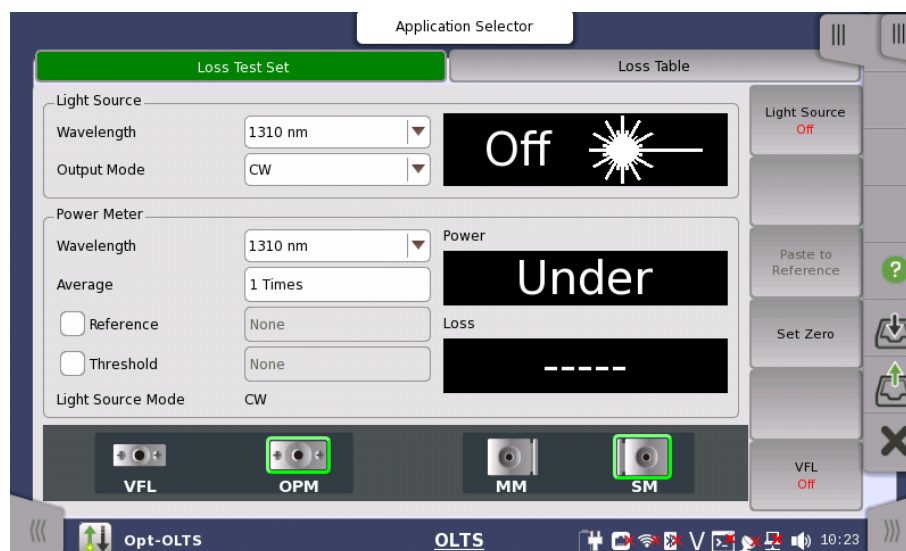

This screen allows you to control the light source and the power meter.

Light Source

Wavelength

Select the wavelength of the light source. The output connector will be indicated by green frame. When Output Mode is set to **Wave Code**, **ALL (SM)** is displayed. For MU100021A, **ALL (MM)** is also displayed.

- **ALL (SM)**: Switches the wavelength of the light outputting to SMF port to each value periodically.
- **ALL (MM)**: Switches the wavelength of the light outputting to MMF port to each value periodically.

Output Mode

Select CW (Continuous Wave), a modulation frequency, or Wave Code.

Selecting **CW** does not modulate the output light. Selecting **Wave Code** modulates the output light with the data of the light source wavelength and its reference value of the power meter.

Power Meter

When the inputted light is being modulating by Wave Code, Wavelength and Reference are set automatically.



Receiving Light Modulated by Wave Code

Wavelength

Select the wavelength of the optical sensor sensitivity in nm (nanometer). Measured optical power appears in **Power** field. If input power is under of measurable range, "Under" is displayed. If input power is over of measurable range "Over" is displayed.

Average

Touch the field and set the averaging time of the power measurement.

Reference

Select the check box when measuring the optical loss. Touch the field to set the reference optical power level in dBm.

Threshold

Select the check box when running Pass/Fail test of the optical loss. Touch the field to set the threshold level of the optical loss in dB.

If measured loss is larger than this value, the back color of loss display will be red.

Light Source Mode

Analyzing the input light automatically displays Output Mode of the light source.

Soft keys

Light Source

Touching the **Light Source** button will switch optical output to on or off. When selecting **On**, the red icon will blink at bottom left of the screen.

Paste to Reference

Touching **Paste to Reference** sets current power to Reference power.

Set Zero

Touching the **Set Zero** button will calibrate the zero level of the optical power meter.

Be sure to set the cap to the optical connector before running Set Zero.

VFL

Allows users to switch visible light output. When selecting **On** or **Blink**, the red icon will blink at bottom left of the screen.



VFL appears if Option 002 is installed.

5.4.2 Loss Table

Touching the **Loss Table** in the navigation area displays the following screen.

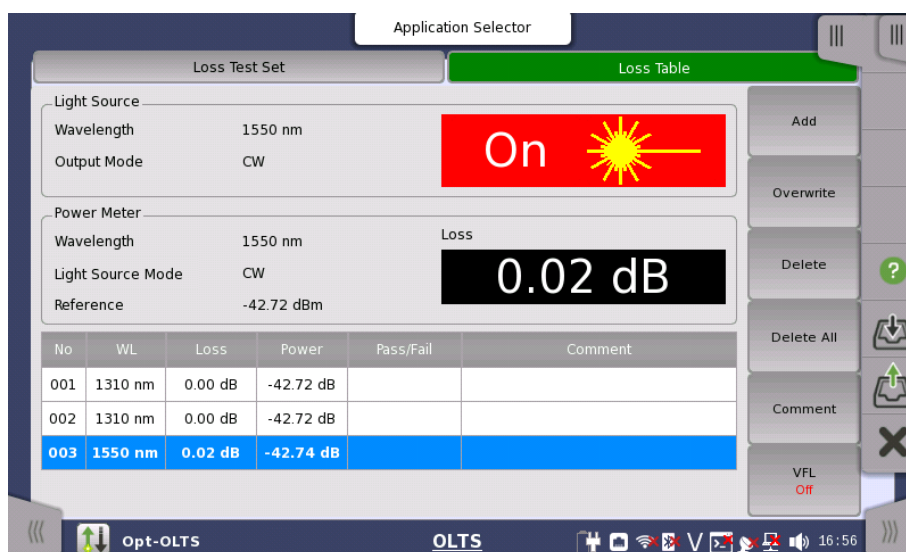

When Light Source Mode of the power meter is **Wave Code**, the power and the loss are displayed.

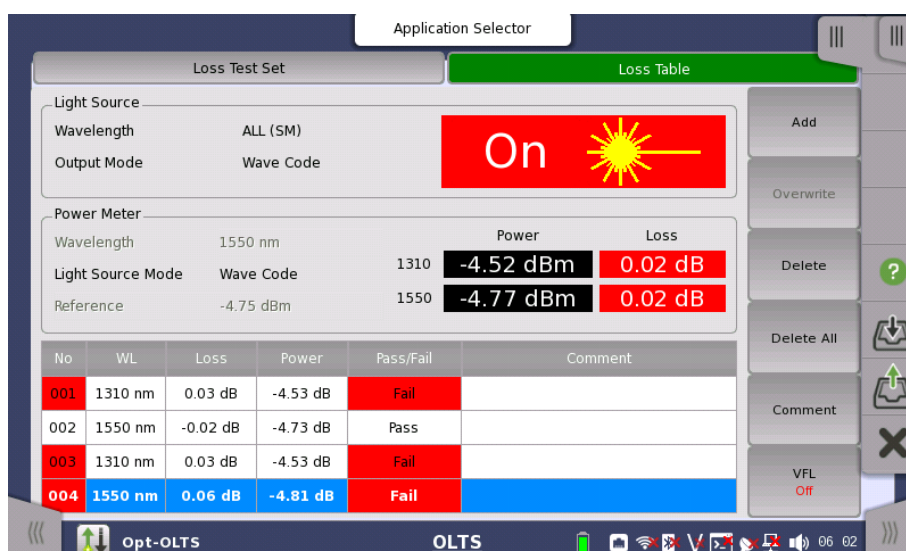

Display Example of MU100020A

Loss Table is the list of optical loss measurement results. This screen allows users to confirm and edit the Loss Table.

To save results to a file, touch  on the [Application toolbar](#).

| | |
|-----------|--|
| No | The number of the measured loss |
| WL | Wavelength of measured loss |
| Loss | Measured loss value |
| Power | Measured optical power value |
| Pass/Fail | Pass or Fail appears if Threshold is selected on "Loss Test Set" screen. When Loss value is equal or less than threshold, "Pass" is displayed. |
| Comment | Comments entered by using the soft key appear. |

Soft keys

Add

Adds the measured optical loss to the table.

Overwrite

Overwrites the measured optical loss to the selected number.

Delete

Deletes the added last item in the table.

Delete All

Deletes all items in the table.

Comment

Launches the dialog box to edit the comment.

VFL

Allows users to switch visible light output. When selecting **On** or **Blink**, the red icon will blink at bottom left of the screen.



VFL appears if Option 002 is installed.

6 Utility Applications

This chapter describes the applications on Utilities screen of Application Selector.

The following applications are available:

- [Scenario](#)
- [GPS](#)
- [PDF Viewer](#)
- [VIP](#)
- [Wireshark](#)

6.1 Scenario

Scenario application executes applications according to the description in the scenario file. The contents of the scenario file can be edited by using the *MX100003A MT1000A/MT1100A Scenario Editor Software* on the PC.



MX100003A MT1000A/MT1100A Scenario Editor Software supports editing Standard OTDR application only.

If the scenario files are not loaded, only Scenario manager icon appears on the [Utilities](#) screen.

If the scenario file has loaded, that icon is displayed on the Utilities screen. The icon of the scenario varies depending on the definition in the scenario.



An example of the scenario icons

Displaying / hiding of the icon can be switched by the Scenario manager screen setting.

6.1.1 Scenario Manager



When you go to the test setup of the Scenario Manager, the following screen is displayed.

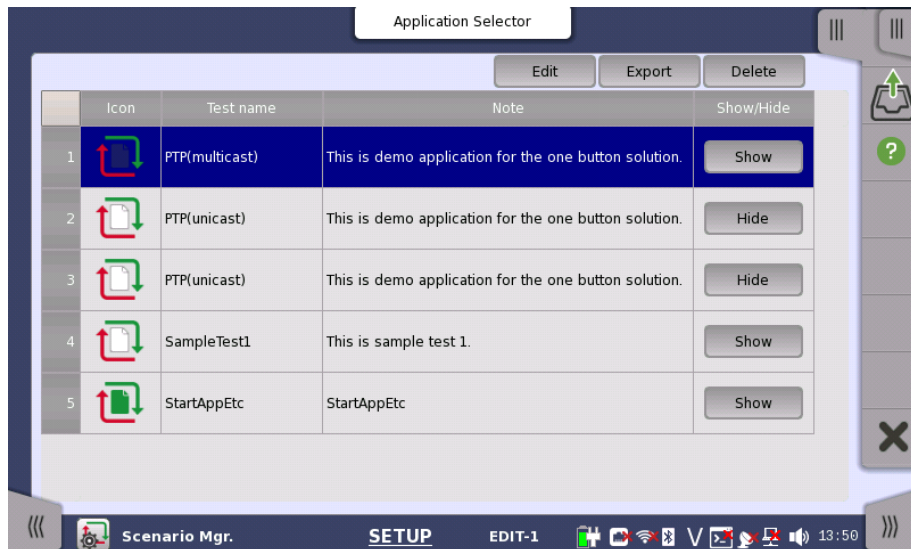

This screen provides following operations:

- Loading a scenario file
- Switching displaying the icon of the scenario or not
- Saving the scenario to file
- Deleting the scenario in the table

Loading a scenario file

1. Touch the on [Application Toolbar](#).
2. Select the file using the dialog box.

3. Touch **Open**.
4. The contents of the loaded scenario appear in the table. Icon, Test name and Note are defined in the scenario. They cannot be edited on the Scenario Manager screen.

Editing the scenario

1. Touch the row of the scenario in the table.
2. Touch **Edit** button. The Edit screen appears.
3. Touching the **Value** field opens the dialog box.

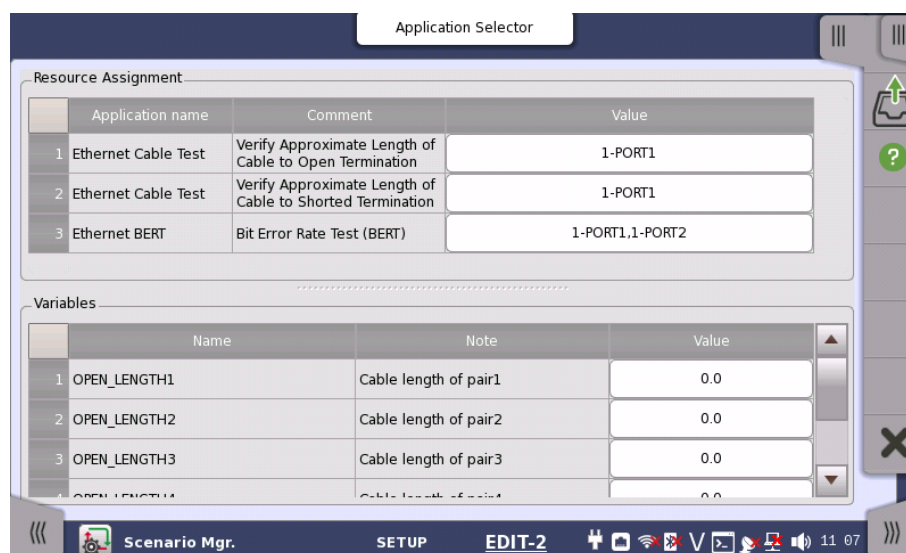

Touch the **SETUP** at the bottom of the screen to return to the setup screen.

 The warning icon appears at right of Resource Assignment when the port defined in the scenario does not exist. In this case, touch the **Value** field and set the available port(s).

Exporting the scenario to the file

Allows user to save the edited scenario.

1. Touch the row of the scenario in the table.
2. Touch **Export** button. The dialog box appears.
3. Enter the file name, then touch **Save**.

Deleting the scenario

This operation deletes the scenario in the table. The scenario file is not deleted.

1. Touch the row of the scenario in the table.
2. Touch **Delete** button.
3. The confirmation dialog box appears. Touch **Yes**.

Hiding/showing the scenario icon

Touch **Hide** button to switch showing or hiding the scenario icon.

Hide: Does not show the scenario icon on the Utilities screen (Displayed currently).

Show: Shows the scenario icon on the Utilities screen (Not displayed currently).

6.1.2 Running the Scenario

When scenario is loaded, the icon appears in Scenario of Utilities screen. If touching the icon, the following screen is displayed.

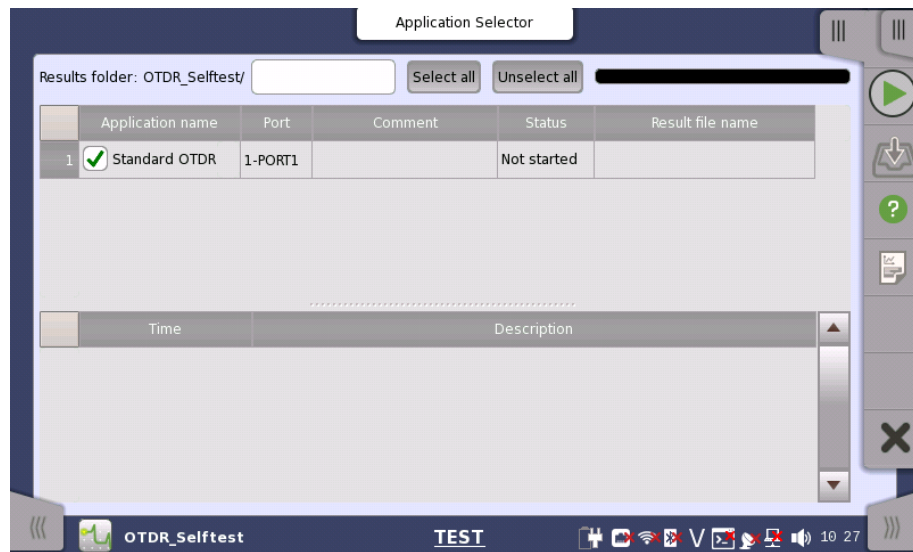

This screen displays the Pass/Fail results and status of the scenario execution. To run the scenario, touch  in the Application Toolbar.

Results folder

The destination folder to save the result file is displayed. Touch the field to open the dialog box and select the folder. If selecting **Auto**, the folder name will be generated automatically.

The button to specify the destination drive appears when touching an icon on Utilities screen after USB memory stick was connected to the Network Master.



Even if **Result Folder :Usb** has been set, result files are stored in Internal memory temporary and moved to USB memory stick after the scenario execution has finished.

In cases below, the warning message appears when Network Master has tried to save result files to USB memory stick. If Network Master failed to save result files to USB memory stick, they are stored in Internal memory.

- USB memory stick was removed.
- The free space of the USB memory stick is shortage.

Application and the result display

In the upper table, Application name, Port number for test use, and comment which are written in the scenario are displayed. If the scenario has executed, the test result and the result file name appear in the each column.

Status indication during Scenario execution

In the lower table, the status of the application and the time that has occurred are displayed.

Save results

1. Touch the  on [Application Toolbar](#)
2. Set the file name using the dialog box displayed.
3. Touch **Save** button.

Generating the report

1. Touch the  on Application Toolbar
2. Setup Report Generator using the dialog box. For details, refer to "Report" in [Application Toolbar](#).
3. Touch **Generate** button.

6.2 GPS



GPS application logs NMEA format data received from the GPS receiver. According to the NMEA format data, the locations of satellite are displayed on the chart.

6.2.1 Test Setup

When you go to the test setup of the GPS application, the following screen is displayed.

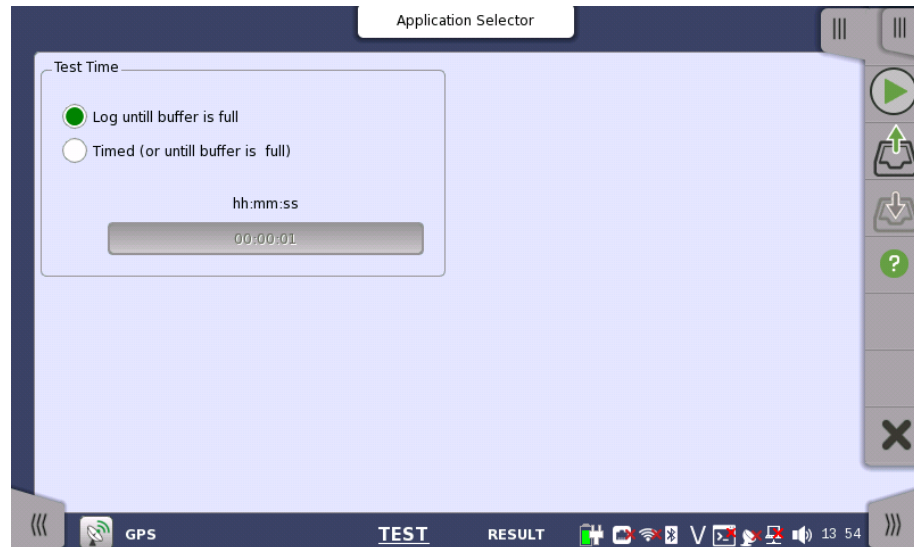

Test Time

Select the how to stop the test.

- **Log until buffer is full:** The test stops when the buffer memory is full with the log data. It takes around 13 hours to fill the buffer.
- **Timed (or until buffer is full):** The test stops when the specified time has elapsed. The test stops if the buffer memory has become full of data even before the specified time has elapsed.

Days, Hours, Minutes

Touch the field to set the test time.

6.2.2 Test Results

When you go to the test result of the GPS application, the following screen is displayed.

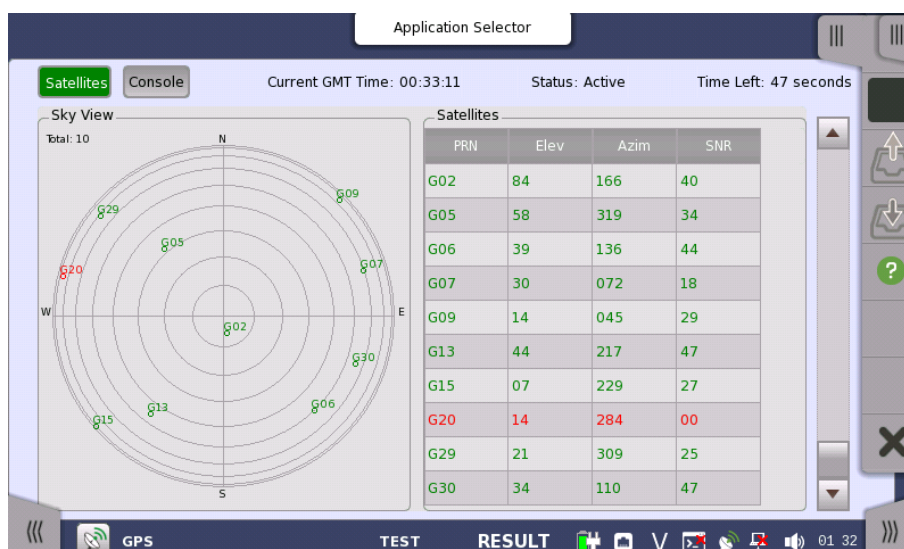

This screen displays positions of satellite and the logged data. Touch a left top button to switch the result to display.

- **Satellites:** Displays the satellite positions by the chart and the table.
- **Console:** Displays the logged data received from GPS receiver.

Touch  to start a test.

Current GMT Time

The time received from GPS appears.

Status

- Active: Data have been receiving from GPS receiver.
- Stopped: Data reception from GPS receiver has stopped.

Time Left

When **Timed** is selected on the Test setup screen, the remaining test time is displayed.

Satellites

Sky View

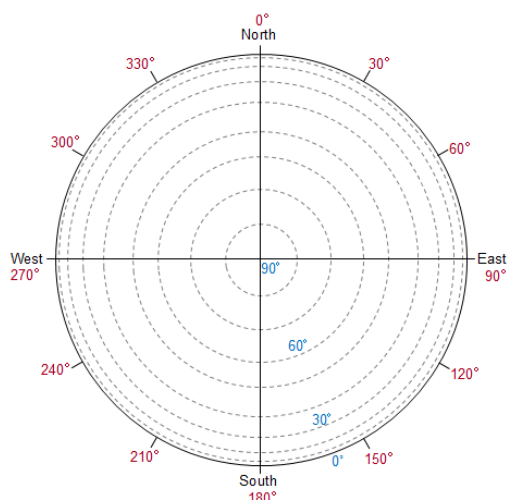

Radius of the circle corresponds to the elevation. The position at circle edge is where the elevation is 0 degree.

Clockwise angle corresponds to the azimuth. Top of the circle corresponds to north.

Satellites

Data of the received satellites are displayed.

- PRN: Displays the satellite number. (Pseudo-Random Noise sequences)

- Elev: Elevation
- Azim: Azimuth
- SNR: Signal to Noise Ratio

Depending on the SNR value, the text color varies in green, blue, or red.

Console

Text Console

The logged data in text data are displayed. You can save the logged data by touching  icon on the Application Toolbar.

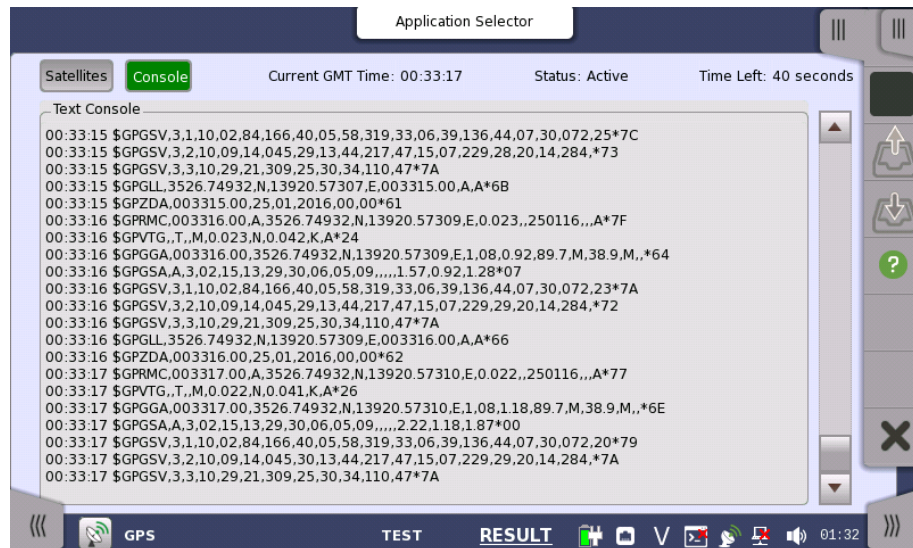

The log data format follows NMEA 0183 rev4.0 that is widely used in the GPS technology.

6.3 PDF Viewer



PDF Viewer allows viewing of PDF files such as report files created by Network Master, Operation Manual, etc.

The screenshot shows the PDF Viewer application interface. At the top, it displays 'File: test.pdf' and 'Application Selector'. The main content area contains several sections:

- Test Information:** A table with fields for File Name, Operator, Cable ID, Location A, Date/Time (2016-04-20 14:50), Fiber ID, and Location B.
- Test Parameters:** A table with columns for Wavelength (1310 nm SM), Distance Range (2500 m), Pulse Width (10 ns), Average Time (10 Sec), and Resolution (0.102 m).
- Test Result Summary:** A table with columns for Wavelength (1310 nm SM), Fiber Length (151.77 m), Total Loss (1.641 dB), Total Events (1), ORL (47.706 dB), and a large green 'PASS' indicator.
- Pass/Fail Thresholds:** A table with columns for Non Reflective Loss (0.20 dB), Reflective Loss (0.50 dB), Reflectance (-35.0 dB), Fiber Loss (1.00 dB/km), Total Loss (3.0 dB), ORL (27.0 dB), and Splitter Loss (3.0 dB).
- Events:** A diagram showing a fiber path from 0.00 m to 151.77 m with a fiber end icon.
- 1310 nm SM Table:** A table with columns for No, Dist (m), Loss (dB), Refl. (dB), Span (m), and Cum.L. (dB). The data row shows: 1, 151.77, Fiber End, **,***, 151.77, 1.641.

The bottom status bar shows 'PDF Viewer', 'Page 1 / 1', and system icons including a clock showing 10:29.

Opening the PDF file

Touching File Open icon () on Application Toolbar launches the dialog box. Select the PDF file using the dialog box.

Scrolling the window

The page number is displayed at bottom center of the screen. Touching < or > side of the page number allows to move the page.

Right hand scroll bar allows to scroll the view vertically.



Following functions are not supported.

- *Zoom in and out*
- *Link*
- *Search*
- *Bookmarks*

6.4 VIP



VIP (Video Inspection Probe) applications allows users to view the edge surface of an optical fiber by using Video Inspection Probe accessory. The captured image and analysis results can be saved to files.

6.4.1 Application Toolbar

Icons for VIP use appear on Application Toolbar.

Capture



Touch the **Capture** icon to capture the current displaying image. When **Auto Focus** is selected in Setup screen, touching this icon performs autofocus and capturing the image.

Press for Live image



Touch the **Press for Live image** icon to display the live image on the screen.

Analyze Image



Touch the **Analyze Image** icon to start analyzing the captured image.

Save



Touch the **Save** icon to save the image and analysis results to files.

Load



Touch the **Load** icon to load a following file.

- Image file (*.png)
- Analysis result file (*.vipi)

Only **Load Save** icon appears on the Expanded Application toolbar. The VIP images and analysis results can be loaded by touching the icon.



The analysis result file (extension vipi) is compatible to following models.

- MT9083 Series Access Master
- MU909014x, MU909015x μ OTDR Module

6.4.2 Connecting the probe

Connect the USB connector of the Video Inspection Probe to Network Master.



G0382A Autofocus Video Inspection Probe

Replace the adaptor of the Video Inspection Probe with one that matches the optical connector.

For handling the Video Inspection Probe, refer to the operation manual that came with the Video Inspection Probe.

Network Master also supports following the Video Inspection Probes.

- OPTION-545VIP USB 200/400x Video Inspect Probe
- G0293A Video Inspection Probe Lite
- G0306A Video Inspection Probe
- G0306B Video Inspection Probe



At the lower left area of the screen, this icon indicates the connection status of the probe.

6.4.3 Test Setup

When you go to the test setup of the VIP application, the following screen is displayed.

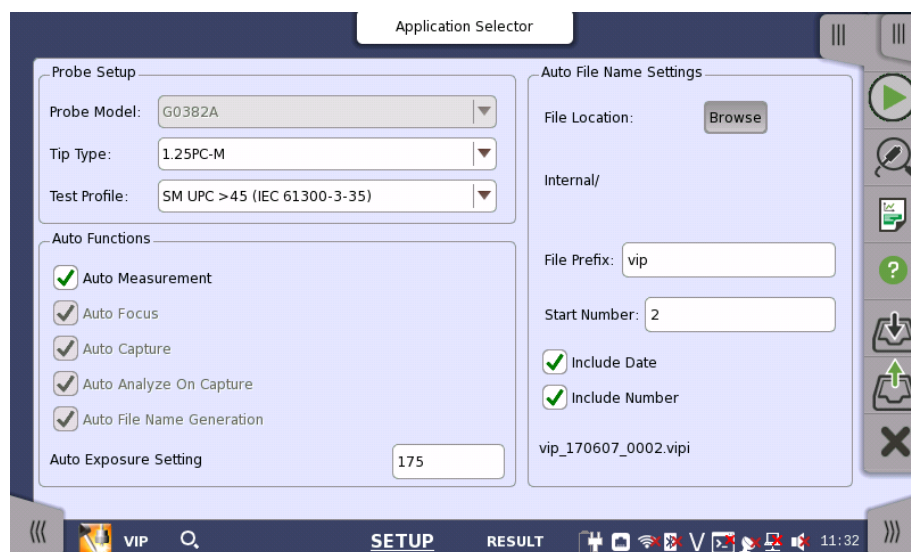

This screen allows you to configure the parameters related to a VIP test.

Probe Setup

Probe Model

When G0306A, G0306B, or G0382A is connected to Network Master, the model is displayed. Otherwise, select the model of the Video Inspection Probe.

Tip Type

Select the tip type to use.

Test Profile

Select the observing fiber type. Limits which will be judged as "Pass" are shown in tables.

In the following tables, "None" means that scratches or defects should be none. "No limit" means that there is no limit to the number of scratches or defects. For example, "None >3 μm" means that scratches or defects larger than 3 μm should be none.

- **SM PC>45:** Single Mode Fiber, Physical Contact, Return Loss is more than 45 dB.

| Zone Name | Defects | Scratches |
|-----------|---|------------------------------|
| Core | None | None |
| Cladding | No limit <2 μm 5 from 2 μm to 5 μm None >5 μm | No limit ≤3 μm None >3 μm |
| Adhesive | No limit | No limit |
| Contact | None ≥10 μm | No limit |

- **SM APC:** Single Mode Fiber, Angled Physical Contact

| Zone Name | Defects | Scratches |
|-----------|---|-----------|
| Core | None | ≤4 |
| Cladding | No limit <2 μm 5 from 2 μm to 5 μm None >5 μm | No limit |
| Adhesive | No limit | No limit |
| Contact | None ≥10 μm | No limit |

- **SM PC>25:** Single Mode Fiber, Physical Contact, Return Loss is more than 25 dB.

| Zone Name | Defects | Scratches |
|-----------|---|---------------------------|
| Core | 2 ≤3 μm None >3 μm | 2 ≤3 μm None >3 μm |
| Cladding | No limit ≤2 μm 5 from 2 μm to 5 μm None >5 μm | No limit ≤3 μm 3 >3 μm |
| Adhesive | No limit | No limit |
| Contact | None ≥10 μm | No limit |

- **MM PC 62.5:** Multi-Mode Fiber, Physical Contact, Core diameter 62.5 μm

| Zone Name | Defects | Scratches |
|-----------|---|---------------------------|
| Core | 4 ≤5 μm None >5 μm | No limit ≤3 μm 0 >5 μm |
| Cladding | No limit ≤2 μm 5 from ≤2 μm to ≤5 μm None >5 μm | No limit ≤5 μm 0 >5 μm |
| Adhesive | No limit | No limit |
| Contact | None ≥10 μm | No limit |

- **MM PC 50.0:** Multi-Mode Fiber, Physical Contact, Core diameter 50 μm
Limits are the same as **MM PC 62.5**.

Auto Functions**Auto Measurement**

When the fiber edge surface is recognized in the image, Auto Focus, Auto Capture, Auto Analyze On Capture, and saving a file will be done automatically.

Auto Measurement is available for G0306A, G0306B, and G0382A.

Auto Focus

When it is recognized that the fiber edge surface is in the image, performs autofocus and capture.



If it cannot be recognized that the fiber edge surface is in the image, VIP may not perform autofocus. In that case, get a focus using < or > button on G0382A.

Auto Focus is available for G0382A.

Auto Capture

When it is recognized that the fiber edge surface is in focus, the image is captured automatically.

Auto Capture is available for G0306A, G0306B, and G0382A.

Auto Analyze On Capture

Executes Auto Analyze when the image has been captured.

Auto File Name Generation

File name is generated automatically when saving the file. Selecting the check box activates **Auto File Name Settings**.

Auto Exposure Setting

The value can be set when **Auto Measurement** is selected. Set target value of auto exposure in the range of 160 to 190.

Auto File Name Settings**File Location**

Touch the **Browse** button to select a folder to save files.

File Prefix

Touch the field and set the string used in the file name. Touching **Quick Matrix** at bottom of **File Prefix Edit** dialog box opens **Input Text** dialog box to register string.

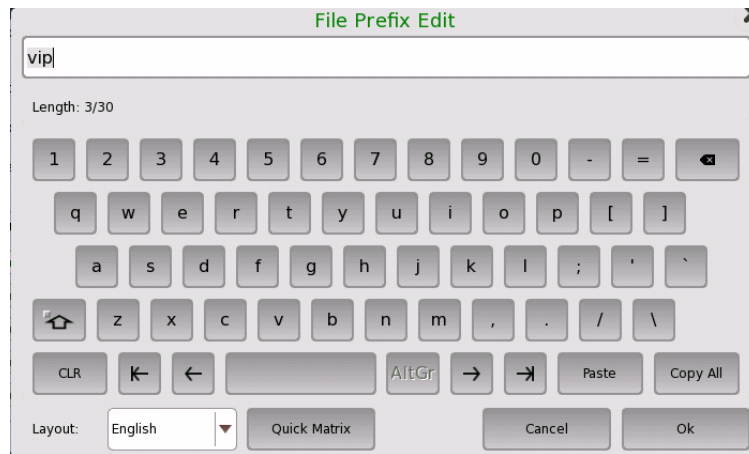

To register string, touch a blank button. Touching labeled button adds the string to file name.

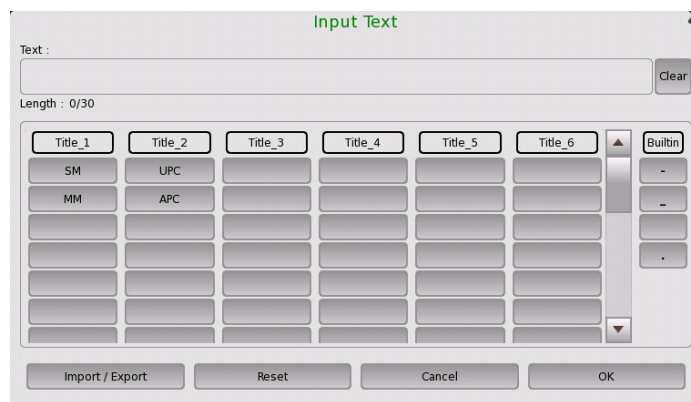

- **Import/Export:** Saves string on buttons to a file or loads string from a file.
- **Reset:** Erases string on all buttons.
- **Cancel:** Discards edited string and closes dialog box.
- **OK:** Applies edited string and closes dialog box.

Start Number

Touch the field and set the start number of value used in the file name.

Include Date

If selecting the check box, date will be appended in the file name.

Include Number

If selecting the check box, a file number will be appended in the file name.

The file name to be generated first is displayed under this item.

6.4.4 Test Results

When you go to the test results of the VIP application, the following screen is displayed.

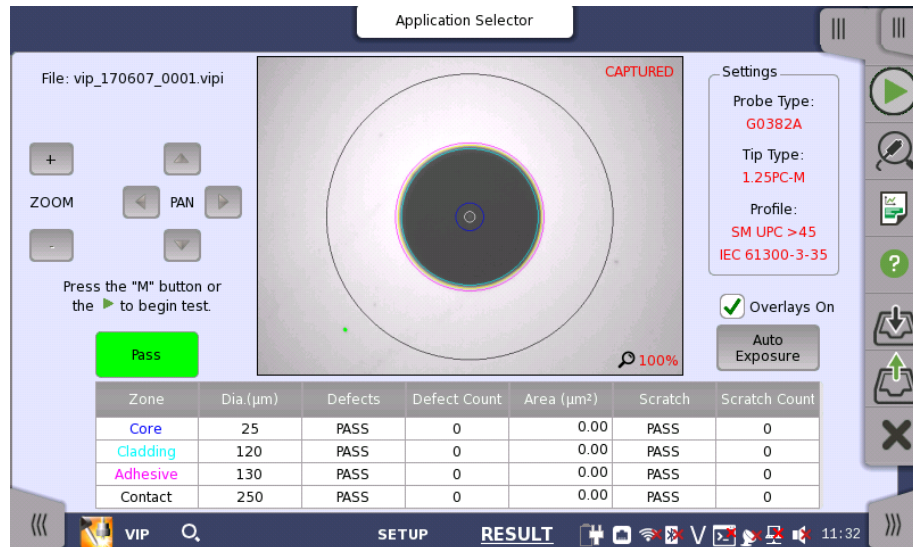

This screen displays the image taken by the fiber scope. Analyzing an image of the fiber edge surface is also available.

Analyzing an image

When **Auto Capture** is not selected, follow the procedure below:

1. Touch .
2. Touch .

After the analysis finishes normally, the results appear in the table.

If **Overlays On** is selected, the circles showing the analysis area appear.

3. Adjust image position by touching **Zoom** buttons or **PAN** buttons.



When using G0382A, pressing M button on VIP starts image capture and analysis.

The items in tables are:

- [Zone]: Name of the analysis area
- [Dia. (μm)]: Measurement result of the diameter
- [Defects]: Judgement result of defects
- [Defect Count]: Number of measured defects
- [Area (μm²)]: Total area of the detected defects
- [Scratch]: Judgement result of scratches
- [Scratch Count]: Number of measured scratches

Overlays On

If selecting the check box, the circles showing the analysis area appear.

Auto Exposure

This button appears when Probe Model is **G0382A**.

Touching the button maintains the image brightness at appropriate level by adjusting exposure.

6.5 Wireshark



Wireshark allows users to analyze captured Ethernet frames.



This application is provided for Ethernet application of Transport modules.

When Wireshark is started, the following screen appears.

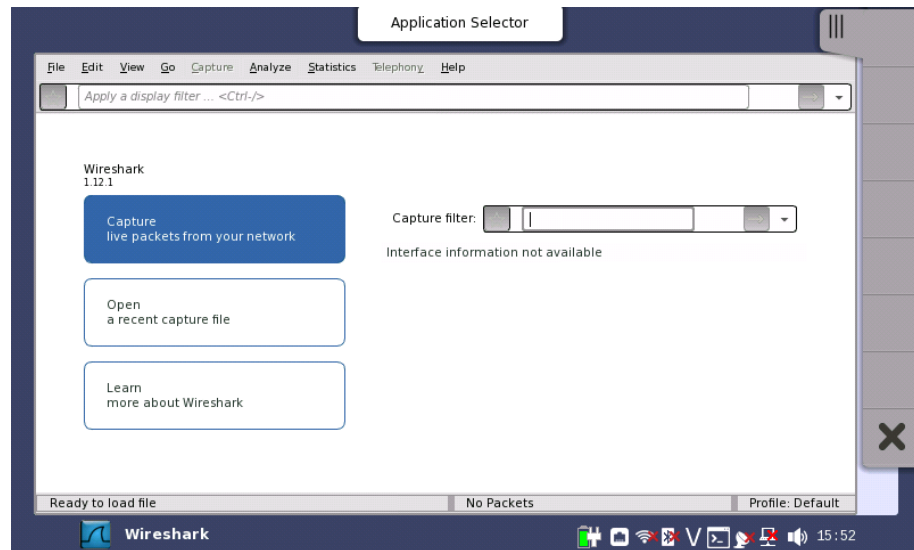

For OTDR modules, there are no applications to analyze using Wireshark.

7 Performance Test and Calibration

This chapter describes how to check the performance of the OTDR module and calibrate measurement values. Contact Anritsu or our sales dealer when the performance test proves that the specifications are not satisfied.

7.1 Performance Test

Clean the optical connector before testing.

Rated values for Each Test Item

Unless otherwise specified, the following rated values are guaranteed at a temperature of 25°C ±5°C.

7.1.1 Required instruments for performance test

The following table shows the instruments and their performance required for the performance tests.

Only MU100021A requires:

Multi mode fiber

Multi mode Optical Coupler

Multi mode Variable Optical Attenuator

Optical-to-Electrical Converter for 850 nm

Required Instruments for Performance Test

| Item | Performance | Name of Recommended Device |
|---|---|---|
| Optical Spectrum Analyzer | Wavelength: 600 to 1650 nm Level: -65 to +20 dBm Wavelength accuracy: ±0.3 nm Supported Single mode / Multi mode Fiber | MS9740A (Anritsu) |
| Single mode Variable Optical Attenuator | Wavelength: 1200 to 1650 nm Insertion loss: 3 dB or less Attenuation: 0 to 30 dB Resolution: 0.001 dB or less | 8163B+81570A (Keysight Technologies) |
| Multi mode Variable Optical Attenuator | Wavelength: 800 to 1350 nm Insertion loss: 3 dB or less Attenuation: 0 to 30 dB Resolution: 0.001 dB or less | 8163B+81578A (Keysight Technologies) |
| Optical-to-Electrical Converter | Wavelength: 1100 to 1650 nm Rising/Falling: 500 ps or less Compatible fiber: Single mode fiber and 62.5 μm Multi mode fiber | P6703B (Tektronix) |
| Optical-to-Electrical Converter | Wavelength: 800 to 900 nm Rising/Falling: 500 ps or less Compatible fiber: 62.5 μm Multi mode fiber | P6701B (Tektronix) |
| Oscilloscope | Bandwidth: DC to 1 GHz | TDS5104B (Tektronix) |
| Single mode fiber | Fiber length: 2 km one, 40 to 50 km one, 500 to 800 m one, 2 to 3 m two | |

Required Instruments for Performance Test (Cont'd)

| Item | Performance | Name of Recommended Device |
|--|--|---|
| Single mode Optical Coupler (1:1) | Structure: 1×2 Splitting ratio: 50%:50% Excess loss: 1 dB or less | |
| Single mode Optical Coupler (10:1) | Structure: 1×2 Splitting ratio: 10%:90% Excess loss: 1 dB or less | |
| Multi mode fiber | Fiber length: 2 km lone, 20 to 25 km one, 500 to 800 m one, 2 to 3 m two | |
| Multi mode Optical Coupler (1:1) | Structure: 1×2 Splitting ratio: 50%:50% Excess loss: 1 dB or less | |
| Multi mode Optical Coupler (10:1) | Structure: 1×2 Splitting ratio: 10%:90% Excess loss: 1 dB or less | |
| Optical Power Meter | Wavelength: 800 to 1650 nm Level: -50 to +10 dBm Accuracy: ±2.5% | 8163B+81623A (Keysight Technologies) |
| Optical Power Meter (Wavelength: 650 nm) | Wavelength: 650 nm Level: -65 to +10 dBm Accuracy: ±0.3 dB | OPM37LAN (Sanwa Electric Instrument Co., Ltd.) |
| Light Source | Wavelength: 1310±5 nm Level: +10 dBm or more Level stability: ±0.1 dB Compatible fiber: Single mode | 81635A #131 (Keysight Technologies) |
| | Wavelength: 1550±5 nm Level: +10 dBm or more Level stability: ±0.1 dB | 81635A #155 (Keysight Technologies) |
| | Wavelength: 850±5 nm Level: +10 dBm or more Level stability: ±0.1 dB | |

7.1.2 Wavelength

Connection diagram

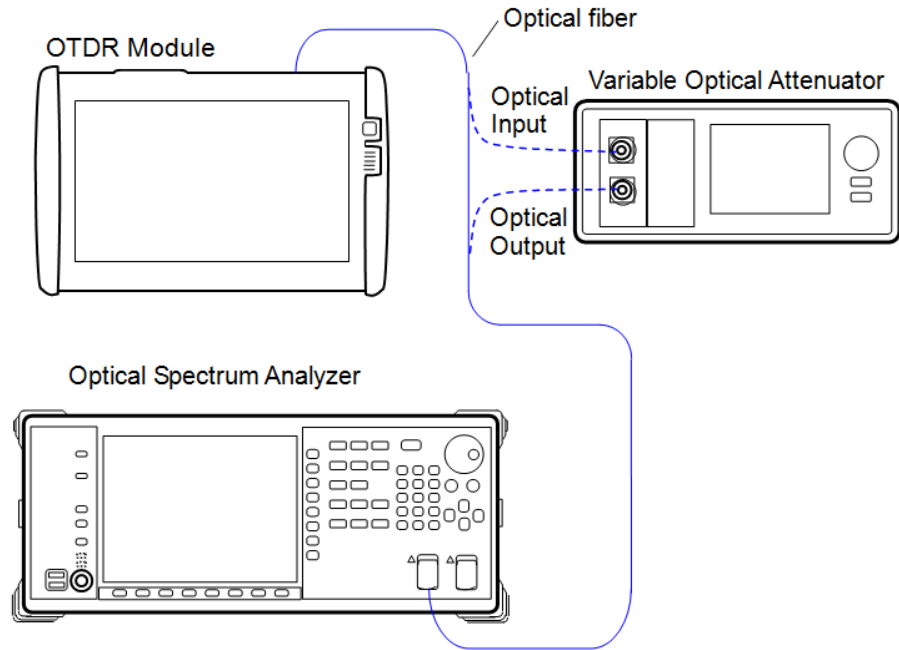

Test Procedure:

1. Connect Network Master and the optical spectrum analyzer.
2. Set the optical spectrum analyzer as follows:
 - Span: 50 nm
 - Res: 0.05 nm
 - VBW: 1 kHz
 - Sampling Point: 2001
 - Analysis: RMS K=1, S.Level: 20 dB
3. Start Standard OTDR application.
4. For MU100021A, set the port in Port screen of SETUP.
5. Set Wavelength in Measurement screen.
6. Set Test mode to **Manual** in Measurement screen and set parameters as follows:

| Wavelength | 1310/1550 nm | 850/1300 nm |
|----------------|--------------|-------------|
| Distance Range | 25km | 2.5km |
| Resolution | Coarse | |
| Pulse Width | 1us | 100ns |

7. Set the wavelength of the Network Master at Center of the spectrum analyzer.
8. Touch .
9. Measure the optical pulse spectrum of the Network Master with the spectrum analyzer.
 - If the waveform level measured by the spectrum analyzer is saturated, adjust the attenuation of the variable optical attenuator.

10. Record the center wavelength measured by the spectrum analyzer.
11. Change Wavelength in the Measurement screen of SETUP and repeat steps 6 to 10 over.

7.1.3 Pulse Width

Connection diagram

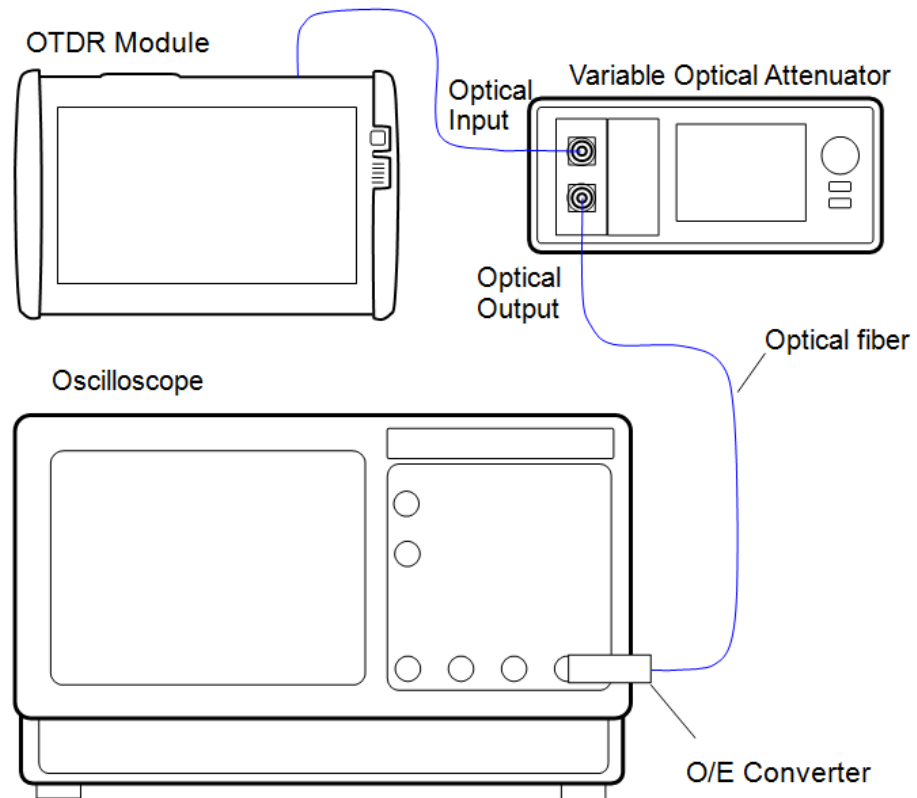

Test Procedure:

1. Connect Network Master and the measuring instruments as shown in Connection diagram.
2. Start Standard OTDR application.
3. For MU100021A, set the port in Port screen of SETUP.
4. Set Wavelength in Measurement screen.
5. Set Test mode to **Manual** in Measurement screen and set parameters as follows:
Distance Range: 0.5km
Pulse Width: 3ns
6. Touch .
7. Adjust the oscilloscope trigger level, amplitude and time base scale to display the waveform in the oscilloscope.
Adjust the optical variable attenuator to prevent the waveform monitor from becoming saturated.
8. Monitor the waveform with the oscilloscope and measure the pulse width at half the amplitude of the peak level as shown in the figure and record the results.

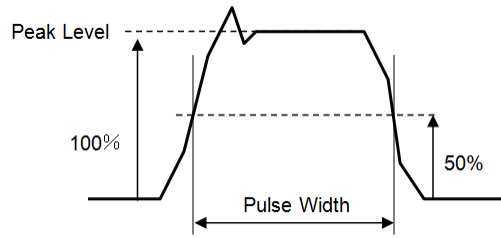

Width of the waveform to be measured

9. Change **Pulse Width** as described in Step 5 and repeat steps 6 to 8 over.
10. Change Wavelength in the Measurement screen of SETUP and repeat steps 5 to 9 over.

7.1.4 Dynamic Range

Connection diagram

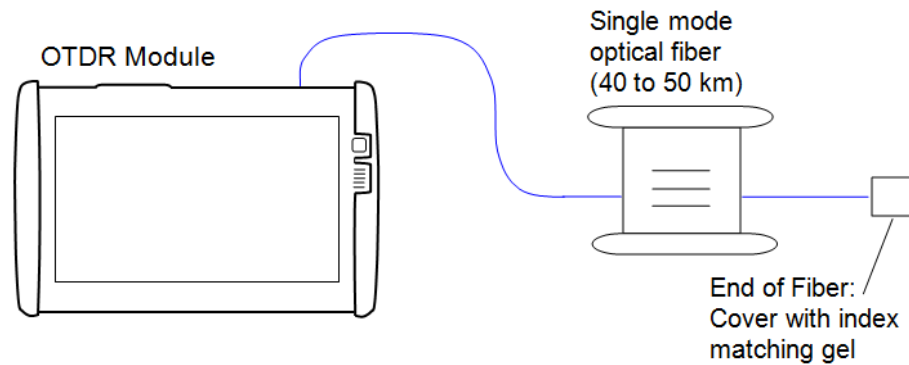

When testing the dynamic range of 850 nm and 1300 nm, change the optical fiber in Connection diagram to the multi-mode fiber (20 to 25 km).

Test Procedure:

1. Connect the optical fiber to Network Master as shown in Connection diagram.
2. Start Standard OTDR application.
3. For MU100021A, set the port in Port screen of SETUP.
4. Set Wavelength in Measurement screen.
5. Set Test mode to **Manual** in Measurement screen and clear **Same Settings** check box. Set parameters as follows:

| Wavelength | 1310/1550 nm | 850 nm | 1300 nm |
|----------------|--------------|--------|---------|
| Distance Range | 100km | 25km | 25km |
| Resolution | Coarse | | |
| Pulse Width | 20us | 500ns | 4us |
| Average Time | 3min | | |

6. Set Loss Mode to **2-pt Loss** in Trace screen of RESULT.
7. Touch .

8. When measurement is completed, move cursor A to the position of the optical output connector .
9. Move cursor B to the peak noise position and record the 2-pt Loss.
10. Add 2.6 dB to the value recorded at step 9. Record the measured result.
11. Change **Port** in Port screen and **Wavelength** in Measurement screen. Repeat steps 7 to 10 over.

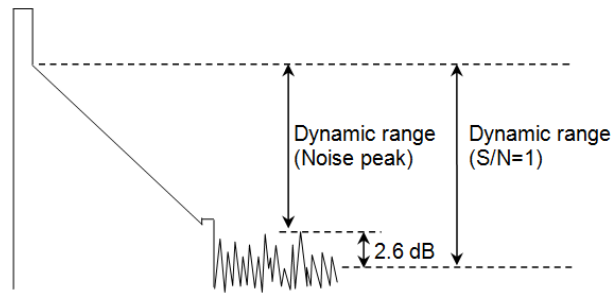

Measurement point on the trace

7.1.5 Distance Measurement Accuracy

Measure the optical fiber whose length and refraction index are known, then perform a horizontal axis (i.e., measurement distance) accuracy test. This is not required for other ranges when this test is performed at a certain distance range.



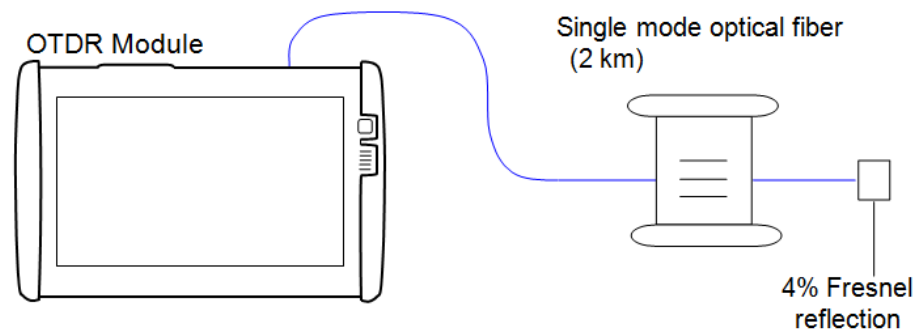

Connection diagram



When testing the distance measurement accuracy of 850 nm and 1300 nm, change the optical fiber in Connection diagram to the multi-mode fiber (2 km).

Test Procedure:

1. Connect the optical fiber to Network Master as shown in Connection diagram.
2. Start Standard OTDR application.
3. For MU100021A, set the port to **Single Mode** in Port screen of SETUP.
4. Set Wavelength to **1310nm** in Measurement screen.

5. Set Test mode to **Manual** in Measurement screen and set parameters as follows:
Distance Range: 2.5km
Resolution: Medium
Pulse Width: 10ns
Average Time: 3min
6. Set the optical fiber's index of refraction to IOR in IOR/BSC screen.
7. Set Loss Mode to **2-pt Loss** in Trace screen of RESULT.
8. Touch .
9. When the measurement is completed, touch  in Trace screen.
10. Move the cursor A to the 0 km position.
11. Move the cursor to the location of Fresnel reflection.
12. Touch  and set the horizontal-axis scale to 0.005 km/div.
13. Touch  and align cursor B precisely with the rise point of the Fresnel reflection.
Record the measured result.
14. Change Wavelength in the Measurement screen of SETUP and repeat steps 6 to 13 over.

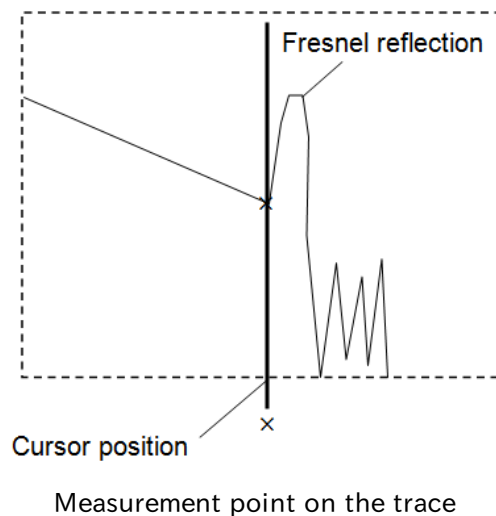

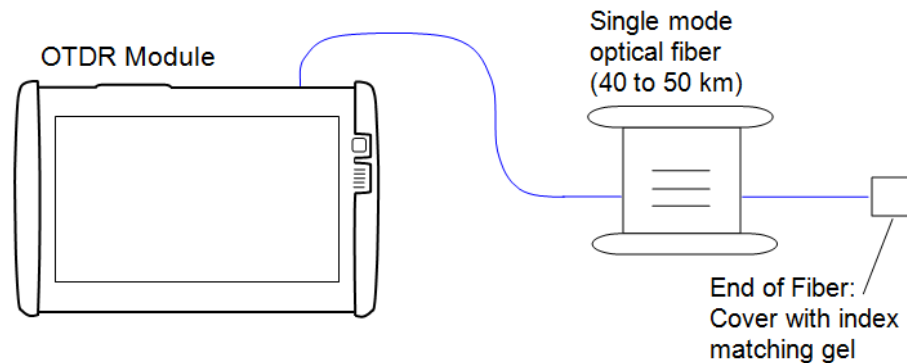

7.1.6 Linearity

Connection diagram





When testing the linearity of 850 nm, change the optical fiber in Connection diagram to the multi-mode fiber (20 to 25 km).

Test Procedure Single mode port:

1. Connect the single mode optical fiber to Network Master.
2. Start Standard OTDR application.
3. For MU100021A, set the port to **Single Mode** in Port screen of SETUP.
4. Set Wavelength to **1310nm** in Measurement screen.
5. Set Test mode to **Manual** in Measurement screen and set parameters as follows:
 - Distance Range: 100km
 - Resolution: Coarse
 - Pulse Width: 2us
 - Average Time: 3min
6. Set Loss Mode to **2-pt LSA** in Trace screen of RESULT.
7. Touch .
8. When the measurement is completed, touch  in Trace screen.
9. Move cursor A to the 0 km position.
10. Move cursor B to the 3 km position.
11. Touch **Utility** and set Cursors to **Locked**.
12. Move cursor LSA1 to the 0.05 km position.
13. Move cursor LSA2 to the 0.3 km position.
14. Move cursor LSA3 to the 2.7 km position.
15. Move cursor LSA4 to the 3.3 km position.
16. Record the loss value.
17. Move cursor A to the 1.5 km position. Cursor B moves to the 4.5 km position.
18. Move cursor LSA1 to the 1.2 km position.
19. Record the loss value.
20. Move cursor A in 1.5-km increments until cursor A reaches the 28.5 km position and record the measured value.

21. Calculate the average of the values recorded from steps 16 to 20.
22. Calculate the difference between the average value in step 21 and the values recorded in steps 16 and multiply this value by 3.

Test Procedure of Multi mode port:

1. Connect the multi mode optical fiber to Network Master.
2. Start Standard OTDR application.
3. For MU100021A, set the port to **Multi Mode** in Port screen of SETUP.
4. Set Wavelength to **850nm** in Measurement screen.
5. Set Test mode to **Manual** in Measurement screen and set parameters as follows:
Distance Range: 10km
Resolution: Coarse
Pulse Width: 100ns
Average Time: 3min
6. Set Loss Mode to **2-pt LSA** in Trace screen of RESULT.
7. Touch .
8. When the measurement is completed, touch  in Trace screen.
9. Move cursor A to the 0 km position.
10. Move cursor B to the 0.6 km position.
11. Touch **Utility** and set Cursors to **Locked**.
12. Move cursor LSA1 to the 0.05 km position.
13. Move cursor LSA2 to the 0.15 km position.
14. Move cursor LSA3 to the 0.5 km position.
15. Move cursor LSA4 to the 0.7 km position.
16. Record the loss value.
17. Move cursor A to the 0.3 km position. Cursor B moves to the 0.9 km position.
18. Move cursor LSA1 to the 0.2 km position.
19. Move cursor LSA2 to the 0.4 km position.
20. Record the loss value.
21. Move cursor A in 0.3-km increments until cursor A reaches the 5.7 km position and record the measured value.
22. Calculate the average of the values recorded from steps 17 to 21.
23. Calculate the difference between the average value in step 22 and the values recorded in steps 16 and multiply this value by 3.



7.1.7 Dead Zone

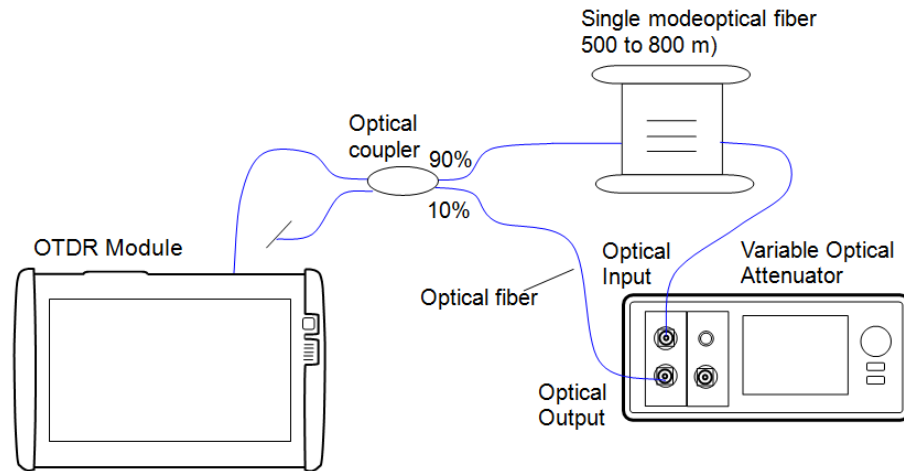

Connection diagram



When testing the dead zone of 850 nm and 1300 nm, change the optical fiber and the optical coupler in Connection diagram to the multi-mode fiber. Use the variable optical attenuator for multi mode fiber.



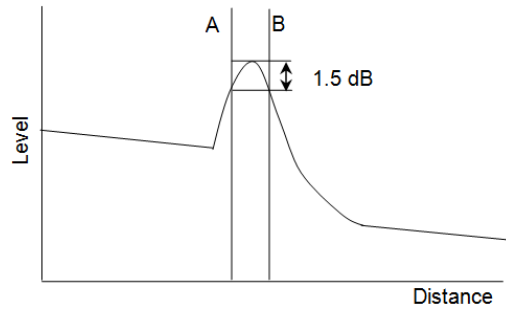

Test Procedure:

1. Connect Network Master and the measuring instruments as shown in Connection diagram.
2. Start Standard OTDR application.
3. For MU100021A, set the port to **Single Mode** in Port screen of SETUP.
4. Set Wavelength to **1310nm** in Measurement screen.
5. Set Test mode to **Manual** in Measurement screen and set parameters as follows:
 - Distance Range: 25km
 - Resolution: Medium
 - Pulse Width: 500ns
 - Average Time: 10s
6. Touch .
7. When the measurement is completed, touch  in Trace screen.
8. Confirm the Fresnel reflection return loss at the 300 to 400 m point in the event table.
9. Adjust the attenuation of the variable optical attenuator so the return loss becomes 40 ± 0.2 dB.
10. Repeat steps 6 to 9 until the return loss in the event table becomes 40 ± 0.2 dB.
11. Set parameters in Measurement screen as follows:
 - Distance Range: 1km
 - Resolution: Medium
 - Pulse Width: 3ns
 - Average Time: 10s
12. Set Loss Mode to **2-pt Loss** in Trace screen of RESULT.

13. Touch .
14. When the measurement is completed, touch  in Trace screen.
15. Move cursor A to the position before the Fresnel reflection where the level is 1.5 dB lower than Fresnel reflection peak.
16. Move cursor B to the position after the Fresnel reflection where the level is 1.5 dB lower than the Fresnel reflection peak.



Cursor Position to Measure Fresnel Dead Zone

17. Record the difference in the position of cursor A and cursor B (Fresnel dead zone).
18. Set parameters in Measurement screen as follows:
 - Distance Range: 25km
 - Resolution: Medium
 - Pulse Width: 500ns
 - Average Time: 10s
19. Touch .
20. When the measurement is completed, touch  in Trace screen.
21. Confirm the Fresnel reflection return loss at the 300 to 400 m point in the event table.
22. Adjust the attenuation of the variable optical attenuator so the return loss becomes 55 ± 0.2 dB.
23. Repeat steps 19 to 22 until the return loss in the event table becomes 55 ± 0.2 dB.
24. Set parameters in Measurement screen as follows:
 - Distance Range: 1km
 - Resolution: Medium
 - Pulse Width: 3ns
 - Average Time: 10s
25. Touch .
26. When the measurement is completed, touch  in Trace screen.
27. Move cursor B to a position 0.5 dB higher than the BSC level of the Fresnel reflection.
28. Move cursor A to the rising position of the Fresnel reflection.

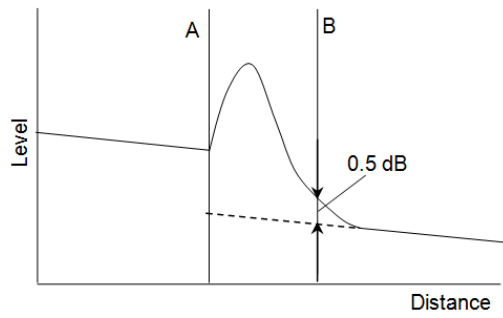

Cursor Position to Measure Backscatter coefficient Dead Zone

29. Record the difference in the position of cursor A and cursor B (backscatter coefficient dead zone).
30. Change the wavelength in Measurement screen and repeat over from step 5 to 29.

When measuring the dead zone of 850 nm and 1300 nm, skip step 18 to 26.

7.1.8 Optical Power Level and Wavelength of VFL

Check that the output power level and wavelength of the optional Visual Fault Locator satisfy their respective specifications.

Connection diagram

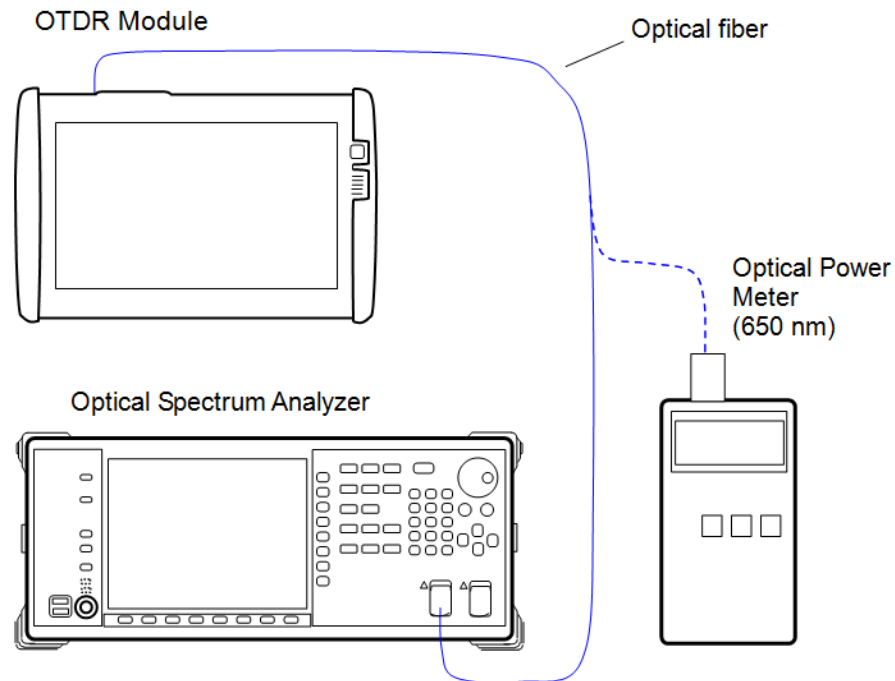

Test Procedure:

1. Connect the VFL port of Network Master to the optical spectrum analyzer.
2. Set the optical spectrum analyzer as follows:
 - Center: 650 nm
 - Span: 50 nm
 - Res: 0.05 nm
 - VBW: 1 kHz
 - Sampling Point: 2001
 - Analysis: Threshold, Cut.Level: 3 dB
3. Start OLTS application.
4. Touch **VFL** soft key.
5. Touch **On**.
6. Measure the center wavelength of the spectrum analyzer and record the result.
7. Set the optical power meter wavelength to 650 nm.
8. Connect the VFL port of Network Master to the optical power meter.
9. Measure the level with the optical power meter and record the result.

7.1.9 Optical Power Level and Wavelength of Light Source

Confirm that the wavelength, spectrum width and optical output level of the light source satisfy their respective specifications.

Connection diagram

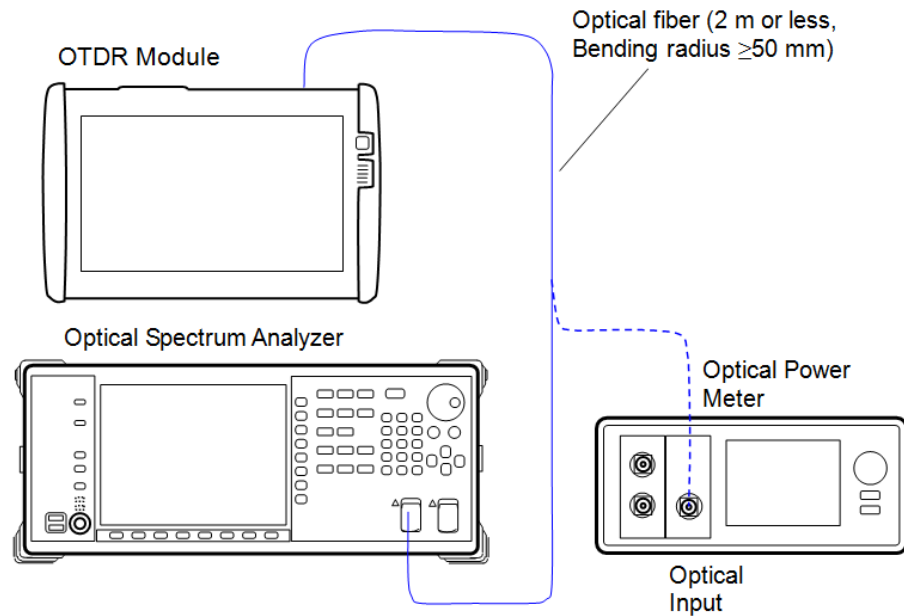

Test Procedure:

The test procedure is described below, taking the 1310-nm wavelength as an example. For the test for other wavelengths, change the waveform setting for the optical spectrum analyzer and optical power meter.

1. Start OLTS application.
2. Set the Light Source - Wavelength to **1310 nm** in Loss Test Set screen.
3. Connect the OLS port of Network Master to the optical spectrum analyzer.
4. Set the optical spectrum analyzer as follows:
 - Center: 1310 nm
 - Span: 50 nm
 - Res: 0.05 nm
 - VBW: 1 kHz
 - Sampling Point: 2001
 - Analysis: Threshold, Cut.Level: 3 dB
5. Set the Light Source - Modulation to **CW**.
6. Touch **Light Source** soft key to change the display to **On**.
7. Measure the center wavelength and spectrum width of the optical spectrum analyzer and record the result.
8. Set the optical power meter wavelength to 1310 nm.
9. Connect the OLS port of Network Master to the optical power meter.
10. Measure the optical output level with the optical power meter and record the result.

7.1.10 Optical Power Meter Measurement Accuracy

Confirm that the measurement accuracy of the power meter satisfy the specifications. Be sure to execute the zero offset of the optical power meter before measurement.

Connection diagram

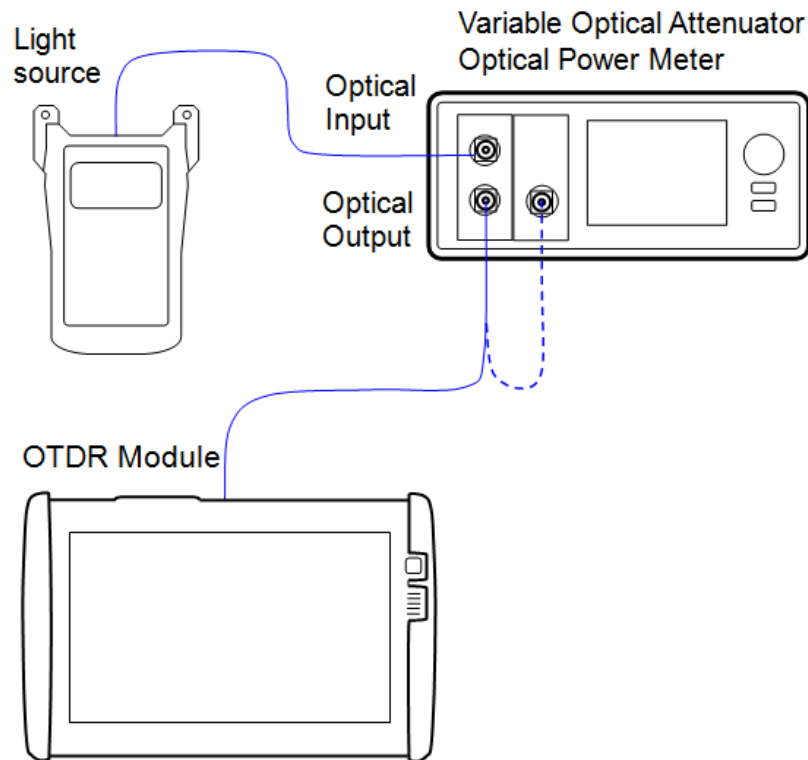

Test Procedure:

The test procedure is described below, taking the 1550-nm wavelength as an example. For the test for other wavelengths, change the waveform setting for the light source and optical power meter.

1. Connect the light source and variable optical attenuator using optical fiber as shown in Connection diagram.
2. Use an optical fiber to connect the output of the variable optical attenuator to the optical power meter.
3. Set the wavelength of the light source to 1550 nm and output the signal.
4. Set the wavelength of the optical power meter to 1550 nm.
5. Adjust the attenuation of the variable optical attenuator so that the optical power meter displays -10 ± 0.005 dBm.
Record the level display of the optical power meter.
6. Disconnect the fiber connected to the power meter and connect to the OPM port of Network Master.
7. Start OLTS application.
8. Set the Power Meter - Wavelength to **1550 nm** in Loss Test Set screen.
9. Record the power display.
10. Calculate the difference between the display levels recorded at steps 6 and 10.

7.2 Calibration

The parameters that can be calibrated are the Backscatter coefficient (BSC) level and the measurement accuracy of OPM (Optical Power Meter).

Annual calibration of OTDR module is recommended.

However, performing the first calibration is recommended 3 years after factory shipment .

7.2.1 Backscatter coefficient level calibration



Backscatter coefficient level calibration

| Item | Rated values | Quantity |
|---------------------------|------------------------|----------|
| Single mode Optical Fiber | 5 km or longer | 2 |
| Optical Connector | With known return loss | 1 |

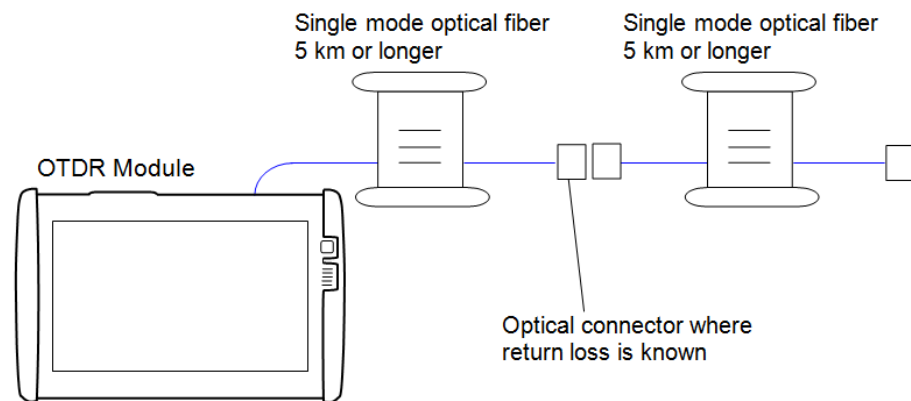
Connection diagram



Calibration Procedure:

1. Prepare an optical connector with a known return loss of R_0 dB and connect it with an optical fiber to the Network Master.
2. Start Standard OTDR application.
3. For MU100021A, set the port to **Single Mode** in Port screen of SETUP.
4. Set Wavelength to **1310nm** in Measurement screen.
5. Set Test mode to **Manual** in Measurement screen and set parameters as follows:
 Distance Range: 10km
 Resolution: Coarse
 Pulse Width: 100ns
 Average Time: 3min
6. Set Loss Mode to **2-pt LSA** in Trace screen of RESULT.
7. Touch .
8. When the measurement is completed, touch  in Trace screen.
9. Touch **Event** soft key and touch **Analyze**.

10. Confirm that the connector event is displayed in the screen and record the return loss. This value is assumed to be R_1 dB.
11. Find the difference between this value and R_0 dB as $\Delta R = (R_1 - R_0)$.
12. Set the sum of the currently set BSC value and ΔR in IOR/BSC screen.
13. Repeat steps 7 to 12 over; calibration is completed when the displayed return losses become the same as the value of R_0 .

7.2.2 Measurement accuracy calibration of optical power meter

To maintain the performance of this power meter, we recommend that calibration be performed once or twice a year.

Please contact Anritsu for calibration of the OPM measurement accuracy.

7.3 Performance Test Result Sheet

Values in Measurement Accuracy column are assumed that Recommended Devices in "Required Instruments for Performance Test" are used.

Wavelength

| Wavelength Settings | Minimum Value | Measured Value | Maximum Value | Measurement Accuracy | Pass/Fail |
|---------------------|---------------|----------------|---------------|----------------------|-------------|
| 1310 nm | 1285 nm | nm | 1335 nm | ±1.83 nm | Pass / Fail |
| 1550 nm | 1525 nm | nm | 1575 nm | ±1.83 nm | Pass / Fail |
| 1625 nm | 1600 nm | nm | 1650 nm | ±1.83 nm | Pass / Fail |
| 850 nm | 820 nm | nm | 880 nm | ±1.86 nm | Pass / Fail |
| 1300 nm | 1270 nm | nm | 1330 nm | ±1.86 nm | Pass / Fail |

Pulse Width (Wavelength 1310 nm)

| Pulse width Settings | Minimum Value* | Measured Value | Maximum Value* | Measurement Accuracy | Pass/Fail |
|----------------------|----------------|----------------|----------------|----------------------|-------------|
| 3 ns | - | ns | - | | Pass / Fail |
| 10 ns | 7 ns | ns | 13 ns | ±2.31% | Pass / Fail |
| 20 ns | 14 ns | ns | 26 ns | ±2.31% | Pass / Fail |
| 50 ns | 35 ns | ns | 65 ns | ±2.31% | Pass / Fail |
| 100 ns | 85 ns | ns | 115 ns | ±2.31% | Pass / Fail |
| 200 ns | 170 ns | ns | 230 ns | ±2.31% | Pass / Fail |
| 500 ns | 465 ns | ns | 535 ns | ±2.31% | Pass / Fail |
| 1 μs | 0.93 μs | μs | 1.07 μs | ±2.31% | Pass / Fail |
| 2 μs | 1.86 μs | μs | 2.14 μs | ±2.31% | Pass / Fail |
| 5 μs | 4.65 μs | μs | 5.35 μs | ±2.31% | Pass / Fail |
| 10 μs | 9.3 μs | μs | 10.7 μs | ±2.31% | Pass / Fail |
| 20 μs | 18.6 μs | μs | 21.4 μs | ±2.31% | Pass / Fail |

*: Indicative values

Pulse Width (Wavelength 1550 nm)

| Pulse width Settings | Minimum Value* | Measured Value | Maximum Value* | Measurement Accuracy | Pass/Fail |
|----------------------|----------------|----------------|----------------|----------------------|-------------|
| 3 ns | - | ns | - | | Pass / Fail |
| 10 ns | 7 ns | ns | 13 ns | ±2.31% | Pass / Fail |
| 20 ns | 14 ns | ns | 26 ns | ±2.31% | Pass / Fail |
| 50 ns | 35 ns | ns | 65 ns | ±2.31% | Pass / Fail |
| 100 ns | 85 ns | ns | 115 ns | ±2.31% | Pass / Fail |
| 200 ns | 170 ns | ns | 230 ns | ±2.31% | Pass / Fail |
| 500 ns | 465 ns | ns | 535 ns | ±2.31% | Pass / Fail |
| 1 μs | 0.93 μs | μs | 1.07 μs | ±2.31% | Pass / Fail |
| 2 μs | 1.86 μs | μs | 2.14 μs | ±2.31% | Pass / Fail |
| 5 μs | 4.65 μs | μs | 5.35 μs | ±2.31% | Pass / Fail |
| 10 μs | 9.3 μs | μs | 10.7 μs | ±2.31% | Pass / Fail |
| 20 μs | 18.6 μs | μs | 21.4 μs | ±2.31% | Pass / Fail |

*: Indicative values

Pulse Width (Wavelength 1625 nm)

| Pulse width Settings | Minimum Value* | Measured Value | Maximum Value* | Measurement Accuracy | Pass/Fail |
|----------------------|----------------|----------------|----------------|----------------------|-------------|
| 3 ns | - | ns | - | | Pass / Fail |
| 10 ns | 7 ns | ns | 13 ns | ±2.31% | Pass / Fail |
| 20 ns | 14 ns | ns | 26 ns | ±2.31% | Pass / Fail |
| 50 ns | 35 ns | ns | 65 ns | ±2.31% | Pass / Fail |
| 100 ns | 85 ns | ns | 115 ns | ±2.31% | Pass / Fail |
| 200 ns | 170 ns | ns | 230 ns | ±2.31% | Pass / Fail |
| 500 ns | 465 ns | ns | 535 ns | ±2.31% | Pass / Fail |
| 1 μs | 0.93 μs | μs | 1.07 μs | ±2.31% | Pass / Fail |
| 2 μs | 1.86 μs | μs | 2.14 μs | ±2.31% | Pass / Fail |
| 5 μs | 4.65 μs | μs | 5.35 μs | ±2.31% | Pass / Fail |
| 10 μs | 9.3 μs | μs | 10.7 μs | ±2.31% | Pass / Fail |
| 20 μs | 18.6 μs | μs | 21.4 μs | ±2.31% | Pass / Fail |

*: Indicative values

Pulse Width (Wavelength 850 nm)

| Pulse width Settings | Minimum Value* | Measured Value | Maximum Value* | Measurement Accuracy | Pass/Fail |
|----------------------|----------------|----------------|----------------|----------------------|-------------|
| 3 ns | - | ns | - | | Pass / Fail |
| 10 ns | 7 ns | ns | 13 ns | ±2.31% | Pass / Fail |
| 20 ns | 14 ns | ns | 26 ns | ±2.31% | Pass / Fail |
| 50 ns | 35 ns | ns | 65 ns | ±2.31% | Pass / Fail |
| 100 ns | 85 ns | ns | 115 ns | ±2.31% | Pass / Fail |
| 200 ns | 170 ns | ns | 230 ns | ±2.31% | Pass / Fail |
| 500 ns | 465 ns | ns | 535 ns | ±2.31% | Pass / Fail |

*: Indicative values

Pulse Width (Wavelength 1300 nm)

| Pulse width Settings | Minimum Value* | Measured Value | Maximum Value* | Measurement Accuracy | Pass/Fail |
|----------------------|----------------|----------------|----------------|----------------------|-------------|
| 3 ns | - | ns | - | | Pass / Fail |
| 10 ns | 7 ns | ns | 13 ns | ±2.31% | Pass / Fail |
| 20 ns | 14 ns | ns | 26 ns | ±2.31% | Pass / Fail |
| 50 ns | 35 ns | ns | 65 ns | ±2.31% | Pass / Fail |
| 100 ns | 85 ns | ns | 115 ns | ±2.31% | Pass / Fail |
| 200 ns | 170 ns | ns | 230 ns | ±2.31% | Pass / Fail |
| 500 ns | 465 ns | ns | 535 ns | ±2.31% | Pass / Fail |
| 1 μs | 0.93 μs | μs | 1.07 μs | ±2.31% | Pass / Fail |
| 2 μs | 1.86 μs | μs | 2.14 μs | ±2.31% | Pass / Fail |
| 4 μs | 3.72 μs | μs | 4.24 μs | ±2.31% | Pass / Fail |

*: Indicative values

Dynamic Range (MU100020A-020)

| Wavelength | Minimum Value | Measured Value | Measurement Accuracy | Pass/Fail |
|------------|---------------|----------------|----------------------|-------------|
| 1310 nm | 38 dB | dB | ±0.39 dB | Pass / Fail |
| 1550 nm | 36.5 dB | dB | ±0.39 dB | Pass / Fail |

Dynamic Range (MU100020A-021)

| Wavelength | Minimum Value | Measured Value | Measurement Accuracy | Pass/Fail |
|------------|---------------|----------------|----------------------|-------------|
| 1310 nm | 41 dB | dB | ±0.39 dB | Pass / Fail |
| 1550 nm | 40 dB | dB | ±0.39 dB | Pass / Fail |

Dynamic Range (MU100020A-022)

| Wavelength | Pulse width Settings | Minimum Value | Measured Value | Measurement Accuracy | Pass/Fail |
|------------|----------------------|---------------|----------------|----------------------|-------------|
| 1310 nm | 20 μ s | 45 dB | dB | ± 0.39 dB | Pass / Fail |
| 1550 nm | 20 μ s | 45 dB | dB | ± 0.39 dB | Pass / Fail |
| 1310 nm | 100 ns | 24 dB | dB | ± 0.39 dB | Pass / Fail |
| 1550 nm | 100 ns | 24 dB | dB | ± 0.39 dB | Pass / Fail |

Dynamic Range (MU100021A-021)

| Wavelength | Pulse width Settings | Minimum Value | Measured Value | Measurement Accuracy | Pass/Fail |
|------------|----------------------|---------------|----------------|----------------------|-------------|
| 850 nm | 500 ns | 28 dB | dB | ± 0.39 dB | Pass / Fail |
| 1300 nm | 1 μ s | 27 dB | dB | ± 0.39 dB | Pass / Fail |
| 1310 nm | 20 μ s | 41 dB | dB | ± 0.39 dB | Pass / Fail |
| 1550 nm | 20 μ s | 40 dB | dB | ± 0.39 dB | Pass / Fail |

Dynamic Range (MU100022A-022)

| Wavelength | Pulse width Settings | Minimum Value | Measured Value | Measurement Accuracy | Pass/Fail |
|------------|----------------------|---------------|----------------|----------------------|-------------|
| 1310 nm | 20 μ s | 46 dB | dB | ± 0.39 dB | Pass / Fail |
| 1550 nm | 20 μ s | 46 dB | dB | ± 0.39 dB | Pass / Fail |
| 1625 nm | 20 μ s | 44 dB | dB | ± 0.39 dB | Pass / Fail |
| 1310 nm | 100 ns | 25 dB | dB | ± 0.39 dB | Pass / Fail |
| 1550 nm | 100 ns | 25 dB | dB | ± 0.39 dB | Pass / Fail |
| 1625 nm | 100 ns | 23 dB | dB | ± 0.39 dB | Pass / Fail |

Distance Measurement Accuracy

| Wavelength | Length of Optical Fiber (km) | Minimum Value (m) | Measured Value (km) | Maximum Value (m) | Pass/Fail |
|------------|------------------------------|-------------------|---------------------|-------------------|-------------|
| 850 nm | | -1.27 | | +1.27 | Pass / Fail |
| 1300 nm | | -1.27 | | +1.27 | Pass / Fail |
| 1310 nm | | -1.27 | | +1.27 | Pass / Fail |
| 1550 nm | | -1.27 | | +1.27 | Pass / Fail |
| 1625 nm | | -1.27 | | +1.27 | Pass / Fail |

Specifications: ± 1 m $\pm(3$ m \times measured distance (m) $\times 10^{-5}$ \pm cursor resolution

When Range is 2.5 km and the horizontal scale is 0.005 km/div, the measurement range is 2500 m and the cursor resolution is 0.2 m.

Linearity (Wavelength 1310 nm, Pulse Width 2 μ s)

| Location of Cursor A (km) | Location of Cursor B (km) | Loss (dB/km) | Minimum Value (dB) | (Difference from Mean Loss) $\times 3$ (dB) | Maximum Value (dB) | Pass/Fail |
|---------------------------|---------------------------|--------------|--------------------|---|--------------------|-------------|
| 0 | 3 | | -0.1 | | +0.1 | Pass / Fail |
| 1.5 | 4.5 | | -0.1 | | +0.1 | Pass / Fail |
| 3 | 6 | | -0.1 | | +0.1 | Pass / Fail |
| 4.5 | 7.5 | | -0.1 | | +0.1 | Pass / Fail |
| 6 | 9 | | -0.1 | | +0.1 | Pass / Fail |
| 7.5 | 10.5 | | -0.1 | | +0.1 | Pass / Fail |
| 9 | 12 | | -0.1 | | +0.1 | Pass / Fail |
| 10.5 | 13.5 | | -0.1 | | +0.1 | Pass / Fail |
| 12 | 15 | | -0.1 | | +0.1 | Pass / Fail |
| 13.5 | 16.5 | | -0.1 | | +0.1 | Pass / Fail |
| 15 | 18 | | -0.1 | | +0.1 | Pass / Fail |
| 16.5 | 19.5 | | -0.1 | | +0.1 | Pass / Fail |
| 18 | 21 | | -0.1 | | +0.1 | Pass / Fail |
| 19.5 | 22.5 | | -0.1 | | +0.1 | Pass / Fail |
| 21 | 24 | | -0.1 | | +0.1 | Pass / Fail |
| 22.5 | 25.5 | | -0.1 | | +0.1 | Pass / Fail |
| 24 | 27 | | -0.1 | | +0.1 | Pass / Fail |
| 25.5 | 28.5 | | -0.1 | | +0.1 | Pass / Fail |
| 27 | 30 | | -0.1 | | +0.1 | Pass / Fail |

Mean Loss dB/km

Mean Difference dB/km

Linearity (Wavelength 850 nm, Pulse Width 100 ns)

| Location of Cursor A (km) | Location of Cursor B (km) | Loss (dB/km) | Minimum Value (dB) | (Difference from Mean Loss) ×3 (dB) | Maximum Value (dB) | Pass/Fail |
|---------------------------|---------------------------|--------------|--------------------|-------------------------------------|--------------------|-------------|
| 0 nm | 0.6 | | -0.1 | | +0.1 | Pass / Fail |
| 0.3 | 0.9 | | -0.1 | | +0.1 | Pass / Fail |
| 0.6 | 1.2 | | -0.1 | | +0.1 | Pass / Fail |
| 0.9 | 1.2 | | -0.1 | | +0.1 | Pass / Fail |
| 1.2 | 1.8 | | -0.1 | | +0.1 | Pass / Fail |
| 1.5 | 2.1 | | -0.1 | | +0.1 | Pass / Fail |
| 1.8 | 2.4 | | -0.1 | | +0.1 | Pass / Fail |
| 2.1 | 2.7 | | -0.1 | | +0.1 | Pass / Fail |
| 2.4 | 3 | | -0.1 | | +0.1 | Pass / Fail |
| 2.7 | 3.3 | | -0.1 | | +0.1 | Pass / Fail |
| 3 | 3.6 | | -0.1 | | +0.1 | Pass / Fail |
| 3.3 | 3.9 | | -0.1 | | +0.1 | Pass / Fail |
| 3.6 | 4.2 | | -0.1 | | +0.1 | Pass / Fail |
| 3.9 | 4.5 | | -0.1 | | +0.1 | Pass / Fail |
| 4.2 | 4.8 | | -0.1 | | +0.1 | Pass / Fail |
| 4.5 | 5.1 | | -0.1 | | +0.1 | Pass / Fail |
| 4.8 | 5.4 | | -0.1 | | +0.1 | Pass / Fail |
| 5.1 | 5.7 | | -0.1 | | +0.1 | Pass / Fail |
| 5.4 | 6 | | -0.1 | | +0.1 | Pass / Fail |

Mean Loss dB/km

Mean Difference dB/km

Fresnel Dead Zone

| Wavelength | Measured Value | Maximum Value | Measurement Accuracy | Pass/Fail |
|------------|----------------|---------------|----------------------|-------------|
| 1310 nm | m | 0.8 m | ±0.05 m | Pass / Fail |
| 1550 nm | m | 0.8 m | ±0.05 m | Pass / Fail |
| 1625 nm | m | 0.8 m | ±0.05 m | Pass / Fail |
| 850 nm | m | 0.8 m | ±0.05 m | Pass / Fail |
| 1300 nm | m | 0.8 m | ±0.05 m | Pass / Fail |

Backscatter Dead Zone

| Wavelength | Measured Value | Maximum Value | Measurement Accuracy | Pass/Fail |
|------------|----------------|---------------|----------------------|-------------|
| 1310 nm | m | 3.8 m | ±0.3 m | Pass / Fail |
| 1550 nm | m | 4.3 m | ±0.3 m | Pass / Fail |
| 1625 nm | m | 4.8 m | ±0.3 m | Pass / Fail |
| 850 nm | m | 4.0 m | ±0.3 m | Pass / Fail |
| 1300 nm | m | 5.0 m | ±0.3 m | Pass / Fail |

Light Source - Wavelength

| Wavelength Settings | Minimum Value | Measured Value | Maximum Value | Measurement Accuracy | Pass/Fail |
|---------------------|---------------|----------------|---------------|----------------------|-------------|
| 1310 nm | 1280 nm | nm | 1340 nm | ±1.83 nm | Pass / Fail |
| 1550 nm | 1520 nm | nm | 1580 nm | ±1.83 nm | Pass / Fail |
| 1625 nm | 1595 nm | nm | 1655 nm | ±1.83 nm | Pass / Fail |
| 850 nm | 820 nm | nm | 880 nm | ±1.86 nm | Pass / Fail |
| 1300 nm | 1270 nm | nm | 1330 nm | ±1.86 nm | Pass / Fail |

Light Source - Spectrum width

| Wavelength Settings | Measured Value | Maximum Value | Measurement Accuracy | Pass/Fail |
|---------------------|----------------|---------------|----------------------|-------------|
| 1310 nm | nm | 5 nm | ±0.23 nm | Pass / Fail |
| 1550 nm | nm | 10 nm | ±0.23 nm | Pass / Fail |
| 1625 nm | nm | 10 nm | ±0.23 nm | Pass / Fail |
| 850 nm | nm | 10 nm | ±0.23 nm | Pass / Fail |
| 1300 nm | nm | 10 nm | ±0.23 nm | Pass / Fail |

Light Source - Level

| Wavelength Settings | Minimum Value | Measured Value | Maximum Value | Measurement Accuracy | Pass/Fail |
|---------------------|---------------|----------------|---------------|----------------------|-------------|
| 1310 nm | -6.5 dBm | dBm | -3.5 dBm | ±0.25 dB | Pass / Fail |
| 1550 nm | -6.5 dBm | dBm | -3.5 dBm | ±0.25 dB | Pass / Fail |
| 1625 nm | -6.5 dBm | dBm | -3.5 dBm | ±0.25 dB | Pass / Fail |
| 850 nm | -6.5 dBm | dBm | -3.5 dBm | ±0.25 dB | Pass / Fail |
| 1300 nm | -6.5 dBm | dBm | -3.5 dBm | ±0.25 dB | Pass / Fail |

Power Meter

| Wavelength Settings | Minimum Value | Measured Value | Maximum Value | Measurement Accuracy | Pass/Fail |
|---------------------|---------------|----------------|---------------|----------------------|-------------|
| 1310 nm | -5% | % | +5% | ±1.87% | Pass / Fail |
| 1550 nm | -5% | % | +5% | ±1.87% | Pass / Fail |
| 850 nm | -10% | % | +10% | ±6.01% | Pass / Fail |

| Wavelength | Optical power meter display | Network Master display | Difference |
|------------|-----------------------------|------------------------|------------|
| 1310 nm | dBm | dBm | dB |
| 1550 nm | dBm | dBm | dB |
| 850 nm | dBm | dBm | dB |

VFL

| Item | Minimum Value | Measured Value | Maximum Value | Measurement Accuracy | Pass/Fail |
|------------|---------------|----------------|---------------|----------------------|-------------|
| Wavelength | 635 nm | nm | 665 nm | ± 1.83 nm | Pass / Fail |
| Level | -2.5 dBm | dBm | +2.5 dBm | ± 0.26 dB | Pass / Fail |

8 Specifications

8.1 MT1000A

This section contains specifications for the Network Master Pro, MT1000A (mainframe).

8.1.1 Configuration

| | |
|---------|---|
| | - Main Frame - |
| MT1000A | Network Master Pro |
| | - Standard Accessories - |
| J0980 | A-2 Power Cord * ¹ |
| J0981 | B4 Power Cord * ¹ |
| J0982 | C7 Power Cord * ¹ |
| J0983 | S3 Power Cord * ¹ |
| J1027 | P4 Power Cord * ¹ |
| G0310A | LiION Battery |
| G0385A | High Power AC Adapter |
| B0690A | Softbag |
| B0728A | Rear Panel Kit |
| Z1746A | Stylus |
| Z1747A | Carrying Strap |
| Z1748A | Handle |
| Z1817A | Utilities ROM * ² |
| W3935AE | MT1000A Transport Modules Quick Reference Guide |

*1: One of these power cord come with according to a shipping destination.

*2: Following manuals are stored:

- W3933AE MT1000A Transport Modules Operation Manual
- W3736AE MT1000A Network Master Pro MT1100A Network Master Flex Remote Scripting Operation Manual
- W3810AE MT1000A Network Master Pro OTDR Modules Operation Manual
- W3859AE MT1000A Network Master Pro OTDR Modules Remote Scripting Operation Manual
- 10580-00423 MT1000A/MU100040A Network Master Pro Operation Manual

| | |
|---------------|-----------------------------------|
| | - Options - |
| MT1000A-003 | Connectivity for WLAN/Bluetooth |
| MT1000A-005 | AUX I/O |
| MT1000A-006 | High Power Supply |
| MT1000A-ES210 | 2 Years Extended Warranty Service |
| MT1000A-ES310 | 3 Years Extended Warranty Service |
| MT1000A-ES510 | 5 Years Extended Warranty Service |

*: Necessary when using MU100011A.

- Optional Accessories -

| | |
|---------|--|
| B0691A | Hard case |
| B0691B | Hard case |
| B0720A | Rear Cover |
| B0729A | Screw 1U |
| B0730A | Screw 2U |
| B0731A | Screw 3U |
| B0732A | Screw Kit |
| B0733A | Hard Case |
| G0306B | Video Inspection Probe |
| G0324A | Battery Charger |
| G0325A | GPS receiver |
| G0382A | Autofocus Video Inspection Probe |
| J1569A | Car 12 Vdc adapter |
| W3933AE | MT1000A Transport Modules Operation Manual |

- Modules -

| | |
|-----------|---|
| MU100010A | 10G Multirate Module |
| MU100011A | 100G Multirate Module |
| MU100020A | OTDR Module 1310/1550nm SMF |
| MU100021A | OTDR Module 1310/1550/850/1300nm SMF/MMF |
| MU100022A | OTDR Module 1310/1550/1625nm SMF |
| MU100040A | CPRI RF Module |
| MU100090A | High Performance GPS Disciplined Oscillator |

8.1.2 External Interfaces

| | |
|--------------------------|--|
| Internal Clock | Accuracy ± 4.6 ppm or less, STRATUM 3 compliant |
| Ref Clock Input | BITS (DS1 1.544 Mbit/s), SETS (E1 2.048 Mbit/s), 2MHz Clock, 10MHz Clock ITU-T G.703 compliant |
| | Connector BNC Jack |
| | Range ± 100 ppm |
| Service interface | USB (A x 2, mini B x 1 Port, Revision 2.0) RJ45 Ethernet (10/100/1000 BASE-T) WLAN (2.4GHz IEEE802.11b/g/n) Bluetooth (BT2.1+EDR) 3.5mm Audio Jack AUX Connector (for connection of optional G0325A GPS receiver) |
| AUX I/O | When AUX I/O option is set, the interface is available by combining with J1705A AUX Conversion Adaptor. J1705A AUX Conversion Adaptor is a standard accessory of the MU100090A. |
| | Ref 1PPS Input TTL 50 Ω /DC |
| | 1PPS Input TTL 50 Ω /DC |
| Remote Control | Ethernet, GPIB (USB-GPIB) |

8.1.3 Other Interfaces

| | |
|---------------------|---------------------------|
| Input device | Power switch, Touch panel |
|---------------------|---------------------------|

| | |
|-----------------------|---|
| LCD | 9 inch display with WVGA resolution (800x480 pixels). |
| LED | On, Standby, Charge |
| Speaker | Built-in monaural speaker |
| Storage Memory | Without MT1000A-x06: 1 GB With MT1000A-x06: 7 GB |

8.1.4 Environment Performance

| | | |
|--------------------------|----|--|
| Voltage | DC | 18 V |
| | AC | 100 V to 240 V, 50/60 Hz Without MT1000A-x06: 3.62 A Max. (with dedicated G0309A AC adaptor) With MT1000A-x06: 6.6 A Max. (with dedicated G0385A AC adaptor) |
| | | Battery Dedicated 10.8 V Rechargeable smart Li-ion battery |
| Power consumption | | Without MT1000A-x06: 65 W max. With MT1000A-x06: 120 W max. |

Battery Charging Time 3 to 6 hours (at 25°C, typical)

| | | |
|--------------------------|-------------------|---|
| Temperature range | Operating: | 0°C to +50°C, ≤85%RH (non-condensing) * |
| | Charging battery: | 0°C to +40°C, ≤85%RH (non-condensing) |
| | Storage: | -30°C to +60°C, ≤90%RH (Excluding battery and AC adapter) |
| | | -20°C to +50°C, ≤90%RH (Including battery and AC adapter) (non-condensing) |

*: The maximum allowed charging temperature will be reduced if the instrument is switched on.

EMC EN61326-1 and EN61000-3-2.

LVD EN61010-1.

Wireless Certification For countries and regions permitting WLAN use, refer to the following URL.
<http://www.anritsu.com/ja-JP/test-measurement/support/downloads/brochures-datasheets-and-catalogs/dwl16689>

8.1.5 Mechanical Performance

Size 163(H) x 257.6 (W) x 43.5(D) (Excluding projections)

Mass 1.6 kg max.

8.2 MU100020A OTDR Module 1310/1550nm SMF

In the following you find specifications for MU100020A OTDR module. The MU100020A specification lists the functionality added to the basic Network Master Pro by installing the MU100020A option. Refer to the *Specifications, MT1000A* section for further information about the Network Master Pro's basic functionality.

8.2.1 Configuration

| | |
|-----------------|---|
| | - Module - |
| MU100020A | OTDR Module 1310/1550nm SMF |
| | - Standard Accessories - |
| J1693A | Universal Connector 2.5mm for OPM |
| J1694A | Universal Connector 1.25mm for OPM |
| W3811AE | MT1000A Network Master Pro OTDR Modules Quick Reference Guide |
| | - Options - |
| MU100020A-002 | Visual Fault Locator |
| MU100020A-ES210 | 2 Years Extended Warranty Service |
| MU100020A-ES310 | 3 Years Extended Warranty Service |
| MU100020A-ES510 | 5 Years Extended Warranty Service |
| | - Polish Type Option - |
| MU100020A-010 | UPC Polish |
| MU100020A-011 | APC Polish |
| | - Dynamic Range Option - |
| MU100020A-020 | Standard Dynamic Range |
| MU100020A-021 | Enhanced Dynamic Range |
| MU100020A-022 | High-Performance Dynamic Range |
| | - Connector Option - |
| MU100020A-025 | FC Connector key width 2.0mm |
| MU100020A-026 | SC Connector |
| MU100020A-037 | FC Connector |
| MU100020A-039 | DIN 47256 Connector |
| MU100020A-040 | SC Connector |

8.2.2 OTDR

| | |
|--------------------------|---|
| Wavelength | 1310 ±25 nm, 1550 ±25 nm |
| | Temperature: 25°C |
| | Pulse width: 1 μs |
| | Except for when charging the battery. |
| Fiber under test | 10/125 μm single mode fiber (ITU-T G.652) |
| Optical Connector | For Option 010 |

FC: Option 037
DIN47256: Option 039
SC: Option 040

For Option 011

FC: Option 025
SC: Option 026

Pulse Width 3, 10, 20, 50, 100, 200, 500 ns, 1, 2, 4, 10, 20 μ s

Dynamic Range (S/N=1)

MU100020A-020

1310 nm: 39 dB
1550 nm: 37.5 dB

Typical value, Pulse width: 20 μ s, Guaranteed value is 1 dB lower than above values.

Measurement conditions are:

SNR=1, Temperature: 25°C, Distance Range: 100 km, Averaging: 180 s
Except for when charging the battery.

MU100020A-021

1310 nm: 42 dB
1550 nm: 41 dB

Typical value, Pulse width: 20 μ s, Guaranteed value is 1 dB lower than above values.

Measurement conditions are:

SNR=1, Temperature: 25°C, Distance Range: 100 km, Averaging: 180 s
Except for when charging the battery.

MU100020A-022

1310 nm: 46 dB (Pulse width: 20 μ s)
1550 nm: 46 dB (Pulse width: 20 μ s)
1310 nm: 25 dB (Pulse width: 100 ns)
1550 nm: 25 dB (Pulse width: 100 ns)

Typical value, Guaranteed value is 1 dB lower than above values.

Measurement conditions are:

SNR=1, Temperature: 25°C, Distance Range: 100 km, Averaging: 180 s
Except for when charging the battery.

Dead Zone (Back-scattered light)

1310 nm: \leq 3.8 m
1550 nm: \leq 4.3 m

IOR=1.500000

Pulse width: 10 ns, Return loss: 55 dB, Deviation: \pm 0.5 dB, Temperature: 25°C
Except for when charging the battery.

| | |
|--|---|
| Dead Zone (Fresnel reflection) | 0.8 m IOR=1.500000 Typical value, Pulse width: 3 ns, Return loss: 40 dB, Temperature: 25°C The width for 1.5 dB lower than the peak value of the reflected waveform Except for when charging the battery. |
| Loss Measurement Accuracy (Linearity) | ±0.05 dB/dB or ±0.1 dB (whichever larger) |
| Return Loss Measurement Accuracy | ±2 dB |
| Distance Measurement Accuracy | ±1 m ±3 × d × 10 ⁻⁵ ± mr d : Measurement distance (m) mr : Cursor resolution However, excludes uncertainty due to IOR |
| Distance Range | 0.5/1/2.5/5/10/25/50/100/200/300 km IOR=1.500000 |
| Sampling Resolution | 0.02/0.05/0.1/0.2/0.5/1/2/5/10/20/40 m |
| Sampling Points | 250001 points max. |
| IOR Setting | 1.300000 to 1.700000 (0.000001 step) |
| Realtime Sweep Time | ≤ 0.2 s Test Mode: Manual Distance Range: 50 km Resolution: Coarse |

8.2.3 Optical Power Meter

| | |
|--|--|
| Applicable Fiber | 10/125 μm single mode fiber (ITU-T G.652) 62.5/125 μm GI fiber |
| Wavelength Range | 800 to 1700 nm |
| Wavelength setting | 850, 1300, 1310, 1490, 1550, 1625, 1650 nm |
| Optical power measurement range | -67 to +6 dBm (CW light, 1550 nm) -60 to +3 dBm (CW light, 850 nm) -70 to +3 dBm (Modulated light, 1550 nm) -63 to +0 dBm (Modulated light, 850 nm) |
| Measurement accuracy | ±5% |

-10 dBm, Wavelength: 1310/1550 nm, CW light, Temperature: 25°C,
after executing zero offset,
When a fiber with master FC connector and a 2.5mm universal connector are
used.

±10%

-10 dBm, Wavelength: 850 nm, CW light, Temperature: 25°C,
after executing zero offset,
When a fiber with master FC connector and a 2.5mm universal connector are
used.

Modulated light measurement CW, 270 Hz, 1 kHz, 2 kHz, Wave Code

Connector 2.5 mm Universal, 1.25 mm Universal

8.2.4 Light Source

Applicable Fiber 10/125 μm single mode fiber (ITU-T G.652)

Optical connector Common with OTDR ports for the each wavelength

Central wavelength 1310 ±30 nm
1550 ±30 nm

CW light, Temperature: 25°C

Spectrum width 1310 nm: ≤5 nm
1550 nm: ≤10 nm

CW light, Temperature: 25°C

Optical output power -5 ±1.5 dBm

CW light, Temperature: 25°C, SM or GI fiber length: 2 m, after warming up

Optical output power instant stability ≤0.1 dB

CW light, at a point between -10 to 50°C [±1°C], difference between maximum and minimum values within one minute, SM fiber length: 2 m
When an optical power meter with 40 dB or greater return loss is used.
After warming up

Modulation CW, 270 Hz, 1 kHz, 2 kHz, Wave Code

Warm-up time 10 minutes (after turning optical output On)

8.2.5 VFL (Option 002)

Central wavelength 650 ±15 nm

Temperature: 25°C

Optical output power 0 ±3 dBm

CW, Temperature: 25°C

| | |
|---------------------------------|--|
| Optical connector | 2.5 mm, universal |
| Outputting optical fiber | 10/125 μ m single mode fiber (ITU-T G.652) |
| Optical output mode | Off, On, Blink |

8.2.6 Environment Performance

| | |
|-------------------------------|--|
| Battery operating time | Operating time: 6 hours (Typ.) Telcordia GR-196-CORE Issue2, September 2010 Temperature: 25°C When combined with MT1000A and charged fully. |
|-------------------------------|--|

| | |
|---------------------------------------|---|
| Temperature and Humidity range | Operating: 0°C to +50°C, \leq 85%RH (non-condensing) Storage: -30°C to +60°C, \leq 90%RH (Excluding battery and AC adapter) -20°C to +50°C, \leq 90%RH (Including battery and AC adapter) (non-condensing) |
|---------------------------------------|---|

| | |
|---------------------|--|
| Laser Safety | IEC 60825-1:2007 Class 1M FDA 21CFR1040.10 and 1040.11 except for deviations pursuant to Laser Notice No.50, issued on June 24, 2007. |
|---------------------|--|

For MU100020A-002

| | |
|--|--|
| | IEC 60825-1:2007 Class 3R FDA 21CFR1040.10 and 1040.11 except for deviations pursuant to Laser Notice No.50, issued on June 24, 2007. |
|--|--|

| | |
|------------|---------------------------|
| EMC | EN61326-1 and EN61000-3-2 |
|------------|---------------------------|

| | |
|------------|-----------|
| LVD | EN61010-1 |
|------------|-----------|

8.2.7 Mechanical Performance

| | |
|-------------|---|
| Size | MU100020A only: 163 (H) x 257.6 (W) x 25 (D) (Excluding projections and the rear panel) When combined to MT1000A: 163 (H) x 257.6 (W) x 84.3 (D) (Excluding projections) When combined to MT1000A and MU100010A: 163 (H) x 257.6 (W) x 102.2 (D) (Excluding projections) |
|-------------|---|

| | |
|-------------|---|
| Mass | MU100020A only: 0.8 kg max. (Excluding the rear panel) When combined to MT1000A: 2.7 kg max. (Including battery (G0310A)) When combined to MT1000A and MU100010A: 3.5 kg max. (Including battery (G0310A)) |
|-------------|---|

8.3 MU100021A OTDR Module 1310/1550/850/1300nm SMF/MMF

In the following you find specifications for MU100021A OTDR module. The MU100021A specification lists the functionality added to the basic Network Master Pro by installing the MU100021A option. Refer to the *Specifications, MT1000A* section for further information about the Network Master Pro's basic functionality.

8.3.1 Configuration

| | |
|-----------------|---|
| | - Module - |
| MU100021A | OTDR Module 1310/1550/850/1300nm SMF/MMF |
| | - Standard Accessories - |
| J1693A | Universal Connector 2.5mm for OPM |
| J1694A | Universal Connector 1.25mm for OPM |
| W3811AE | MT1000A Network Master Pro OTDR Modules Quick Reference Guide |
| | - Options - |
| MU100021A-002 | Visual Fault Locator |
| MU100021A-ES210 | 2 Years Extended Warranty Service |
| MU100021A-ES310 | 3 Years Extended Warranty Service |
| MU100021A-ES510 | 5 Years Extended Warranty Service |
| | - Polish Type Option - |
| MU100021A-010 | UPC Polish |
| MU100021A-011 | APC Polish |
| | - Dynamic Range Option - |
| MU100021A-021 | Enhanced Dynamic Range |
| | - Connector Option - |
| MU100021A-025 | FC Connector key width 2.0mm |
| MU100021A-026 | SC Connector |
| MU100021A-037 | FC Connector |
| MU100021A-039 | DIN 47256 Connector |
| MU100021A-040 | SC Connector |

8.3.2 OTDR

| | |
|--------------------------|---|
| Wavelength | 850 \pm 30 nm, 1300 \pm 30 nm, 1310 \pm 25 nm, 1550 \pm 25 nm |
| | Temperature: 25°C |
| | Pulse width: 1 μ s (1310/1550 nm), 100 ns (580/1300 nm) |
| | Except for when charging the battery. |
| Fiber under test | 10/125 μ m single mode fiber (ITU-T G.652) |
| | 62.5/125 μ m GI fiber |
| Optical Connector | For Option 010 and the connector for MMF |

FC: Option 037
 DIN47256: Option 039
 SC: Option 040

For Option 011

FC: Option 025
 SC: Option 026

Pulse Width
 1310/1550 nm: 3, 10, 20, 50, 100, 200, 500 ns, 1, 2, 4, 10, 20 μ s
 850 nm: 3, 10, 20, 50, 100, 200, 500 ns
 1300 nm: 3, 10, 20, 50, 100, 200, 500 ns, 1, 2, 4 μ s

Dynamic Range (S/N=1)
MU100021A-021
 850 nm: 29 dB (Pulse width 500 ns, Distance Range: 25 km) *
 1300 nm: 28 dB (Pulse width 5 μ s, Distance Range: 25 km) *
 1310 nm: 42 dB (Pulse width 20 μ s, Distance Range: 100 km)
 1550 nm: 41 dB (Pulse width 20 μ s, Distance Range: 100 km)

Typical value, Guaranteed value is 1 dB lower than above values.
 SNR=1, Temperature: 25°C, Averaging: 180 s
 Except for when charging the battery.
 *: The dynamic range is lowered by about 3 dB when using a 50/125 μ m optical fiber.

Dead Zone (Back-scattered light)
 850 nm: \leq 4.0 m
 1300 nm: \leq 5.0 m
 1310 nm: \leq 3.8 m
 1550 nm: \leq 4.3 m

IOR=1.500000, Deviation: \pm 0.5 dB, Temperature: 25°C
 For 1310 nm and 1550 nm, Pulse width: 10 ns, Return loss: 55 dB
 For 850 nm and 1300 nm, Pulse width: 3 ns, Return loss: 40 dB
 Except for when charging the battery.

Dead Zone (Fresnel reflection) 0.8 m
 IOR=1.500000
 Typical value, Pulse width: 3 ns, Return loss: 40 dB, Temperature: 25°C
 The width for 1.5 dB lower than the peak value of the reflected waveform
 Except for when charging the battery.

Loss Measurement Accuracy (Linearity) \pm 0.05 dB/dB or \pm 0.1 dB (whichever larger)

Return Loss Measurement Accuracy
 850/1300 nm: \pm 4 dB
 1310/1550 nm: \pm 2 dB

Specifications

| | |
|--------------------------------------|--|
| Distance Measurement Accuracy | $\pm 1 \text{ m} \pm 3 \times d \times 10^{-5} \pm mr$ d : Measurement distance (m) mr : Cursor resolution (m) However, excludes uncertainty due to IOR |
| Distance Range | 850/1300 nm: 0.5/1/2.5/5/10/25/50/100 km 1310/1550 nm: 0.5/1/2.5/5/10/25/50/100/200/300 km IOR=1.500000 |
| Sampling Resolution | 0.02/0.05/0.1/0.2/0.5/1/2/5/10/20/40 m |
| Sampling Points | 250001 points max. |
| IOR Setting | 1.300000 to 1.700000 (0.000001 step) |
| Realtime Sweep Time | $\leq 0.2 \text{ s}$ Test Mode: Manual Distance Range: 50 km Resolution: Coarse |

8.3.3 Optical Power Meter

| | |
|--|---|
| Applicable Fiber | 10/125 μm single mode fiber (ITU-T G.652) 62.5/125 μm GI fiber |
| Wavelength Range | 800 to 1700 nm |
| Wavelength setting | 850, 1300, 1310, 1490, 1550, 1625, 1650 nm |
| Optical power measurement range | -67 to +6 dBm (CW light, 1550 nm) -60 to +3 dBm (CW light, 850 nm) -70 to +3 dBm (Modulated light, 1550 nm) -63 to +0 dBm (Modulated light, 850 nm) |
| Measurement accuracy | $\pm 5\%$ -10 dBm, Wavelength: 1310/1550 nm, CW light, Temperature: 25°C, after executing zero offset, When a fiber with master FC connector and a 2.5mm universal connector are used. $\pm 10\%$ -10 dBm, Wavelength: 850 nm, CW light, Temperature: 25°C, after executing zero offset, When a fiber with master FC connector and a 2.5mm universal connector are used. |
| Modulated light measurement | CW, 270 Hz, 1 kHz, 2 kHz, Wave Code |

Connector 2.5 mm Universal, 1.25 mm Universal

8.3.4 Light Source

Applicable Fiber 10/125 μ m single mode fiber (ITU-T G.652)

62.5/125 μ m GI fiber

Optical connector Common with OTDR ports for the each wavelength

Central wavelength 850 \pm 30 nm

1300 \pm 30 nm

1310 \pm 30 nm

1550 \pm 30 nm

CW light, Temperature: 25°C

Spectrum width 850 nm: \leq 10 nm

1300 nm: \leq 10 nm

1310 nm: \leq 5 nm

1550 nm: \leq 10 nm

CW light, Temperature: 25°C

Optical output power -5 \pm 1.5 dBm

CW light, Temperature: 25°C, SM or GI fiber length: 2 m, after warming up

Optical output power instant stability 1310/1550 nm: \leq 0.1 dB

CW light, at a point between -10 to 50°C [\pm 1°C], difference between maximum and minimum values within one minute, SM fiber length: 2 m
When an optical power meter with 40 dB or greater return loss is used (SM)
After warming up

850/1300 nm: Not specified

Modulation CW, 270 Hz, 1 kHz, 2 kHz, Wave Code

Warm-up time 10 minutes (after turning optical output On)

8.3.5 VFL (Option 002)

Central wavelength 650 \pm 15 nm

Temperature: 25°C

Optical output power 0 \pm 3 dBm

CW, Temperature: 25°C

Optical connector 2.5 mm, universal

Outputting optical fiber 10/125 μ m single mode fiber (ITU-T G.652)
Optical output mode Off, On, Blink

8.3.6 Environment Performance

Battery operating time Operating time: 6 hours (Typ.)
Telcordia GR-196-CORE Issue2, September 2010
Temperature: 25°C
When combined with MT1000A and charged fully.

Temperature and Humidity range Operating: 0°C to +50°C, \leq 85%RH (non-condensing)
Storage: -30°C to +60°C, \leq 90%RH (Excluding battery and AC adapter)
-20°C to +50°C, \leq 90%RH (Including battery and AC adapter)
(non-condensing)

Laser Safety IEC 60825-1:2007 Class 1M
FDA 21CFR1040.10 and 1040.11 except for deviations pursuant to Laser Notice No.50, issued on June 24, 2007.

For MU100021A-002

IEC 60825-1:2007 Class 3R
FDA 21CFR1040.10 and 1040.11 except for deviations pursuant to Laser Notice No.50, issued on June 24, 2007.

EMC EN61326-1 and EN61000-3-2.

LVD EN61010-1.

8.3.7 Mechanical Performance

Size MU100021A only:
163 (H) x 257.6 (W) x 25 (D) (Excluding projections and the rear panel)

When combined to MT1000A:
163 (H) x 257.6 (W) x 84.3 (D) (Excluding projections)

When combined to MT1000A and MU100010A:
163 (H) x 257.6 (W) x 102.2 (D) (Excluding projections)

Mass MU100021A only:
0.8 kg max. (Excluding the rear panel)

When combined to MT1000A:
2.7 kg max. (Including battery (G0310A))

When combined to MT1000A and MU100010A:
3.5 kg max. (Including battery (G0310A))

8.4 MU100022A OTDR Module 1310/1550/1625nm SMF

In the following you find specifications for MU100022A OTDR module. The MU100022A specification lists the functionality added to the basic Network Master Pro by installing the MU100022A option. Refer to the *Specifications, MT1000A* section for further information about the Network Master Pro's basic functionality.

8.4.1 Configuration

| | |
|-----------------|---|
| | - Module - |
| MU100022A | OTDR Module 1310/1550/1625nm SMF |
| | - Standard Accessories - |
| J1693A | Universal Connector 2.5mm for OPM |
| J1694A | Universal Connector 1.25mm for OPM |
| W3811AE | MT1000A Network Master Pro OTDR Modules Quick Reference Guide |
| | - Options - |
| MU100022A-002 | Visual Fault Locator |
| MU100022A-ES210 | 2 Years Extended Warranty Service |
| MU100022A-ES310 | 3 Years Extended Warranty Service |
| MU100022A-ES510 | 5 Years Extended Warranty Service |
| | - Polish Type Option - |
| MU100022A-010 | UPC Polish |
| MU100022A-011 | APC Polish |
| | - Dynamic Range Option - |
| MU100022A-022 | High-Performance Dynamic Range |
| | - Connector Option - |
| MU100022A-025 | FC Connector key width 2.0mm |
| MU100022A-026 | SC Connector |
| MU100022A-037 | FC Connector |
| MU100022A-039 | DIN 47256 Connector |
| MU100022A-040 | SC Connector |

8.4.2 OTDR

| | |
|--------------------------|---|
| Wavelength | 1310 ±25 nm, 1550 ±25 nm, 1625 ±25 nm |
| | Temperature: 25°C |
| | Pulse width: 1 μs |
| | Except for when charging the battery. |
| Fiber under test | 10/125 μm single mode fiber (ITU-T G.652) |
| Optical Connector | For Option 010 |
| | FC: Option 037 |
| | DIN47256: Option 039 |
| | SC: Option 040 |
| | For Option 011 |

FC: Option 025
 SC: Option 026

Pulse Width 3, 10, 20, 50, 100, 200, 500 ns, 1, 2, 4, 10, 20 μ s

Dynamic Range (S/N=1)

MU100022A-022

1310 nm: 46 dB (Pulse width: 20 μ s)

1550 nm: 46 dB (Pulse width: 20 μ s)

1625 nm: 44 dB (Pulse width: 20 μ s)

1310 nm: 25 dB (Pulse width: 100 ns)

1550 nm: 25 dB (Pulse width: 100 ns)

1625 nm: 23 dB (Pulse width: 100 ns)

Typical value, Guaranteed value is 1 dB lower than above values.

Measurement conditions are:

SNR=1, Temperature: 25°C, Distance Range: 100 km, Averaging: 180 s
 Except for when charging the battery.

Dead Zone (Back-scattered light)

1310 nm: \leq 3.8 m

1550 nm: \leq 4.3 m

1625 nm: \leq 4.8 m

IOR=1.500000

Pulse width: 10 ns, Return loss: 55 dB, Deviation: \pm 0.5 dB, Temperature: 25°C
 Except for when charging the battery.

Dead Zone (Fresnel reflection)

0.8 m

IOR=1.500000

Typical value, Pulse width: 3 ns, Return loss: 40 dB, Temperature: 25°C
 The width for 1.5 dB lower than the peak value of the reflected waveform
 Except for when charging the battery.

Loss Measurement Accuracy (Linearity)

\pm 0.05 dB/dB or \pm 0.1 dB (whichever larger)

Return Loss Measurement Accuracy

\pm 2 dB

Distance Measurement Accuracy

\pm 1 m \pm 3 \times $d \times 10^{-5} \pm mr$

d : Measurement distance (m)

mr : Cursor resolution

However, excludes uncertainty due to IOR

Distance Range

0.5/1/2.5/5/10/25/50/100/200/300 km

IOR=1.500000

Sampling Resolution 0.02/0.05/0.1/0.2/0.5/1/2/5/10/20/40 m

Sampling Points 250001 points max.

IOR Setting 1.300000 to 1.700000 (0.000001 step)

Realtime Sweep Time ≤ 0.2 s

Test Mode: Manual
Distance Range: 50 km
Resolution: Coarse

8.4.3 Optical Power Meter

Applicable Fiber 10/125 μ m single mode fiber (ITU-T G.652)

62.5/125 μ m GI fiber

Wavelength Range 800 to 1700 nm

Wavelength setting 850, 1300, 1310, 1490, 1550, 1625, 1650 nm

Optical power measurement range -67 to +6 dBm (CW light, 1550 nm)

-60 to +3 dBm (CW light, 850 nm)

-70 to +3 dBm (Modulated light, 1550 nm)

-63 to +0 dBm (Modulated light, 850 nm)

Measurement accuracy $\pm 5\%$

-10 dBm, Wavelength: 1310/1550 nm, CW light, Temperature: 25°C,
after executing zero offset,

When a fiber with master FC connector and a 2.5mm universal connector are used.

$\pm 10\%$

-10 dBm, Wavelength: 850 nm, CW light, Temperature: 25°C,
after executing zero offset,

When a fiber with master FC connector and a 2.5mm universal connector are used.

Modulated light measurement CW, 270 Hz, 1 kHz, 2 kHz, Wave Code

Connector 2.5 mm Universal, 1.25 mm Universal

8.4.4 Light Source

Applicable Fiber 10/125 μ m single mode fiber (ITU-T G.652)

Optical connector Common with OTDR ports for the each wavelength

Central wavelength 1310 ± 30 nm

1550 ± 30 nm

1625 ±30 nm
CW light, Temperature: 25°C

Spectrum width 1310 nm: ≤5 nm
1550 nm: ≤10 nm
1625 nm: ≤10 nm
CW light, Temperature: 25°C

Optical output power -5 ±1.5 dBm
CW light, Temperature: 25°C, SM or GI fiber length: 2 m, after warming up

Optical output power instant stability ≤0.1 dB
CW light, at a point between -10 to 50°C [±1°C], difference between maximum and minimum values within one minute, SM fiber length: 2 m
When an optical power meter with 40 dB or greater return loss is used.
After warming up

Modulation CW, 270 Hz, 1 kHz, 2 kHz, Wave Code

Warm-up time 10 minutes (after turning optical output On)

8.4.5 VFL (Option 002)

Central wavelength 650 ±15 nm
Temperature: 25°C

Optical output power 0 ±3 dBm
CW, Temperature: 25°C

Optical connector 2.5 mm, universal

Outputting optical fiber 10/125 μm single mode fiber (ITU-T G.652)

Optical output mode Off, On, Blink

8.4.6 Environment Performance

Battery operating time Operating time: 6 hours (Typ.)
Telcordia GR-196-CORE Issue2, September 2010
Temperature: 25°C
When combined with MT1000A and charged fully.

Temperature and Humidity range Operating: 0°C to +50°C, ≤85%RH (non-condensing)
Storage: -30°C to +60°C, ≤90%RH (Excluding battery and AC adapter)
-20°C to +50°C, ≤90%RH (Including battery and AC adapter)
(non-condensing)

Laser Safety IEC 60825-1:2007 Class 1M

FDA 21CFR1040.10 and 1040.11 except for deviations pursuant to Laser Notice No.50, issued on June 24, 2007.

For MU100022A-002

IEC 60825-1:2007 Class 3R

FDA 21CFR1040.10 and 1040.11 except for deviations pursuant to Laser Notice No.50, issued on June 24, 2007.

EMC EN61326-1 and EN61000-3-2

LVD EN61010-1

8.4.7 Mechanical Performance

Size MU100022A only:
163 (H) x 257.6 (W) x 25 (D) (Excluding projections and the rear panel)

When combined to MT1000A:
163 (H) x 257.6 (W) x 84.3 (D) (Excluding projections)

When combined to MT1000A and MU100010A:
163 (H) x 257.6 (W) x 102.2 (D) (Excluding projections)

Mass MU100022A only:
0.8 kg max. (Excluding the rear panel)

When combined to MT1000A:
2.7 kg max. (Including battery (G0310A))

When combined to MT1000A and MU100010A:
3.5 kg max. (Including battery (G0310A))

9 Support

This chapter contains information about general maintenance of the Network Master. It also contains information on how to obtain support or service assistance.

9.1 Maintenance and Cleaning

This section contains information about general maintenance and cleaning of the Network Master.

9.1.1 Maintenance

The Network Master does not require any regular adjustments.

Using the Network Master in a normal environment and under normal conditions will not call for general maintenance.

WARNING

There are no user-serviceable parts in the Network Master. Possible service or repair should be performed by Anritsu authorized personnel only.

9.1.2 Cleaning

From time to time the Network Master needs to be cleaned. The surfaces of the Network Master can be cleaned with any mild detergent that does not contain solvents.

Before any cleaning, please take notice of the warnings below:

WARNING

Disconnect the Network Master from the mains power connection before any cleaning involving fluid.

- Only use a soft cloth moisturized with a mild detergent to clean the surface of the touch screen.
 - Clean the main power adapter regularly. If dust accumulates around the power pins, there is a risk of fire.
 - Keep the cooling fan clean so that the ventilation holes are not obstructed. If the ventilation is obstructed, the cabinet may overheat and catch fire.
-

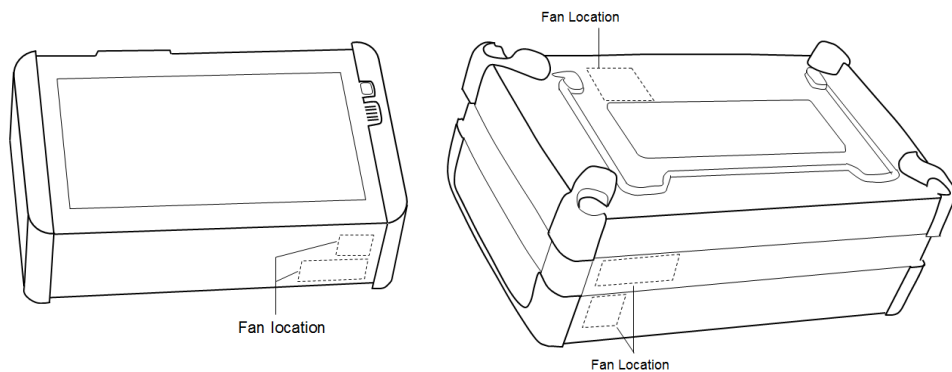

MT1000A and OTDR module

MT1000A, OTDR module and MU100010A

9.2 Notes On Storage

Remove any dust or dirt adhering to the equipment before storage.

Remove batteries from the Network Master.

Pack accessories, such as adapters and Utilities ROM, etc., into the accessories box and store it with the main frame.

Avoid storing in these places:

- In direct sunlight
- Dusty places
- Damp places where condensation may occur on the equipment's surface
- Places with active/corrosive gases
- Places where the equipment may be oxidized
- Places where there is a risk of vibration or mechanical shock
- Places where there is a risk of packing boxes falling over
- Places where the temperature and humidity are as follows:
Temperature: -20°C or lower, or 50°C or higher
Humidity: 90% or higher

Recommended storage conditions

It is recommended that the equipment be stored in a place that meets the ambient conditions suggested above, plus the following conditions, if it is not to be used for a long period of time:

- Temperature: 5°C to 45°C
- Humidity: 40% to 80%
- Little temperature and humidity fluctuations within 1 day

9.3 Formatting the data area in the Network Master

Occasionally it is required to remove customer data from Network Master such as after instrument rental. With Software tools you can format Network Master internal data area.

Two data areas are available: Data area and Property area.

Data area contains user rewritable data. Property area contains system data.

Each area can be formatted with tools stored on a USB memory stick. The tools are stored on the Utilities ROM. Please refer to the following description to format.

To perform Data area formatting, copy

"REFORMAT_DATA_AREA.MT1000_SW" to root of USB memory stick.

To perform Property area formatting, copy

"REFORMAT_PROPERTY_AREA.MT1000_SW" to root of USB memory stick.

Place the format tools in the root of an empty of USB memory stick. To perform both kinds of formattings simultaneously, place both tools in the root together.

Procedure

1. Remove power cable and turn instrument off. Power button turns off.
2. Insert the USB memory stick with the tools in one of the USB Type-A ports.
3. Connect power cable or push power button to turn power on. Then formatting is executed and Network Master will reboot automatically.
4. Remove USB memory stick. The formatting is completed.

9.4 Upgrading the Software



Connect the AC adapter to the Network Master while updating the software. When updating the software with battery operation, make sure that there is 40% (or more) power in the battery of the Network Master.

Installation by using USB memory stick

Visit our website and download the latest version. We have two types of installers as below.

MT1000A_Software with MU100011A: For using MT1000A which module configuration includes MU100011A.

MT1000A_Software: For using MT1000A which module configuration does not include MU100011A.



"MT1000A_Software with MU100011A" is consisted from two files. Copy both files to USB memory stick and perform the installation. Note that installing "MT1000A_Software" is not able to work the MU100011A.

1. Copy the installer onto an empty USB memory stick.
2. If USB memory stick is inserted to the Network Master, remove it. If the Network Master is powered-down while the USB memory stick is still inserted, there is a risk that the USB memory stick may not operate normally after the installation.
3. Press the power button to shut down the Network Master. Never force to power off by holding the power button pressed for several seconds.
4. Remove AC adapter or power cable and confirm the power button turns to gray.
5. Insert the USB memory stick into the Network Master.
6. Connect AC adapter to the Network Master.
7. Press the power button to boot the Network Master.

The Network Master will detect the installer stored in the USB memory stick, and start installing the software. After the installation has finished, the Network Master will reboot.

If the software is installed on battery operation without connecting AC adapter, Network Master does not reboot. Press the power button to boot the Network Master.

When installing MT1000A software which includes MU100011A, the installation of MU100011A data starts automatically at the Network Master rebooting.

8. Check the software version at [System Information](#) on the **Instrument Toolbar**.
9. Remove USB memory stick after the installation has completed.

9.5 Support and Service Assistance

In case your Network Master needs support or service, follow the instructions given in the sub-sections below.

9.5.1 Before you obtain assistance

To ensure fast help the Anritsu representative or the Anritsu Customer Services need detailed information about the Network Master and the problems concerning the Network Master. The minimum information required is listed below:

- A file containing the system information. The file can be generated using the  icon in the *instrument toolbar*.
- Possible error code displayed on the touch screen, or any other error indications
- A detailed description of the problem and how it occurred. Please make the description as detailed as possible, e.g. by drawing an illustration and/or saving relevant screen captures.

9.5.2 Obtaining Support or Service Assistance

In the event that this equipment malfunctions, contact an Anritsu Service and Sales office. Contact information is available in a separate file on the PDF version.

9.6 Transporting and Disposal

This section describes the precautions to observe when transporting and disposing of the main frame.

9.6.1 Repackaging

Use the original shipping materials, or an approved optional transit case, when repacking the unit for transport. Repack according to the following procedure when the original shipping materials (or a transit case) are not available.

1. Procure a corrugated cardboard, wooden, or aluminum box large enough to pack in cushioning material around the unit.
2. Wrap the main frame in some material such as plastic sheeting that will prevent entry of dust and water.
3. Place the unit into the box.
4. Pack soft materials around the main frame so that it cannot slide around inside the packing box.
5. Secure the outside of the box with packaging cord, adhesive tape, bands, or other such implements.

9.6.2 Transporting

In addition to preventing vibration as much as possible, transport under conditions meeting the storage conditions outlined above.

9.6.3 Disposal

When the Network Master has reached the end of its useful life, dispose of it in accordance with local environmental regulations. Before disposal, dismantle or physically destroy any non-volatile memory media in the Network Master to ensure that data in memory cannot be recovered by third parties.

9.7 Special Information

9.7.1 Equipment Certificate

Anritsu Corporation certifies that this equipment was tested before shipment using calibrated measuring instruments with direct traceability to public testing organizations, and was found to meet the published specifications.

9.7.2 Anritsu Warranty

Anritsu Corporation will repair this equipment free-of-charge if a malfunction occurs within one year after shipment due to a manufacturing fault. However, software fixes will be made in accordance with the separate Software End-User License Agreement. Moreover, Anritsu Corporation will deem this warranty void when:

- The fault is outside the scope of the warranty conditions separately described in the operation manual.
- The fault is due to mishandling, misuse, or unauthorized modification or repair of the equipment by the customer.
- The fault is due to severe usage clearly exceeding normal usage.
- The fault is due to improper or insufficient maintenance by the customer.
- The fault is due to natural disaster, including fire, wind, flooding, earthquake, lightning strike, or volcanic ash, etc.
- The fault is due to damage caused by acts of destruction, including civil disturbance, riot, or war, etc.
- The fault is due to explosion, accident, or breakdown of any other machinery, facility, or plant, etc.
- The fault is due to use of non-specified peripheral or applied equipment or parts, or consumables, etc.
- The fault is due to use of a non-specified power supply or in a non-specified installation location.
- The fault is due to use in unusual environments(Note).
- The fault is due to activities or ingress of living organisms, such as insects, spiders, fungus, pollen, or seeds.

In addition, this warranty is valid only for the original equipment purchaser. It is not transferable if the equipment is resold.

Anritsu Corporation shall assume no liability for injury or financial loss of the customer due to the use of or a failure to be able to use this equipment.

Note:

For the purpose of this Warranty, "unusual environments" means use:

- In places of direct sunlight
- In dusty places
- In liquids, such as water, oil, or organic solvents, and medical fluids, or places where these liquids may adhere
- In salty air or in places where chemically active gases (sulfur dioxide, hydrogen sulfide, chlorine, ammonia, nitrogen dioxide, or hydrogen chloride etc.) are present
- In places where high-intensity static electric charges or electromagnetic fields are present

- In places where abnormal power voltages (high or low) or instantaneous power failures occur
- In places where condensation occurs
- In the presence of lubricating oil mists
- In places at an altitude of more than 2,000 m
- In the presence of frequent vibration or mechanical shock, such as in cars, ships, or airplanes

9.7.3 Anritsu Corporation Contact

In the event of this equipment malfunctions, contact an Anritsu Service and Sales office. Contact information can be found on the last page of the printed version of this manual, and is available in a separate file on the PDF version.

9.7.4 Licensing Information

This product includes copyrighted third-party software licensed under the terms of the GNU General Public License.

Please see the GNU General Public License for the exact terms and conditions of this license.

Especially the following parts of this product are subject to GNU GPL:

- The Linux operating system kernel
- The busybox swiss army knife of embedded linux
- e2fsprogs - filesystem utilities for use with the ext2 filesystem

All listed software packages are copyrighted by their respective authors. Please see the source code for detailed information.

9.7.5 Availability of Source Code

Anritsu Corporation has the full source code of the GPL licensed software, including any scripts to control compilation of the object code.

9.8 Software License Document

Network Master comes with the package software as described in following Table. Note, however, that the package software is not covered by the Anritsu Software License Agreement.

Go to the following website for details of each license.

<http://www.anritsu.com/ja-JP/test-measurement/support/downloads/manuals/dwl16668>

| Software License | | |
|------------------|-----------|-------------|
| Name | Version | License |
| ace_tao | 2.2a | custom |
| alsa-lib | 1.0.24.1 | LGPL |
| alsa-utils | 1.0.24.2 | GPL |
| atk | 2.10.0-1 | LGPL |
| at-spi | 1.32.0-5 | GPL |
| at-spi2-atk | 2.10.2-1 | GPL2 |
| at-spi2-core | 2.10.2-1 | GPL2 |
| attr | 2.4.47-1 | LGPL |
| avahi | 0.6.31-11 | LGPL |
| bash | 2.05b | GPL2 |
| binutils | 2.24-1 | GPL |
| bluez | 4.101 | GPL |
| bluez-tools | 0.1.38 | GPL |
| busybox | 1.20.2 | GPL2 |
| cairo | 1.12.16-1 | LGPL,MPL |
| compositeproto | 0.4 | MIT |
| coreutils | 8.23-1 | GPL3 |
| cups-filters | 1.0.41-1 | GPL |
| damageproto | 1.1.0 | MIT |
| dbus | 1.4.14 | GPL,custom |
| dbus-glib | 0.82 | GPL2,custom |
| DirectFB | 1.4.0 | LGPL |
| dosfstools | 3.0.26-1 | GPL2 |
| e2fsprogs | 1.41.4 | GPL |
| expat | 2.0.1 | MIT |
| fontconfig | 2.11.0-1 | custom |
| font-util | 1.0.1 | MIT |
| freetype | 2.3.9 | GPLorFTL |
| gdb | 6.6 | GPL |
| gdk-pixbuf2 | 2.30.2-1 | LGPL2.1 |
| glib | 1.2.10-11 | LGPL |
| glib2 | 2.38.2-1 | LGPL |
| glibc | 2.17-5.1 | GPL,LGPL |

Software License (Cont'd)

| Name | Version | License |
|---------------------------|-----------|-----------------|
| gmp | 5.1.3-2 | LGPL3 |
| gnutls | 3.2.7-1 | GPL3,LGPL2.1 |
| graphite | 1:1.2.4-1 | LGPL,GPL,custom |
| gsettings-desktop-schemas | 3.10.1-1 | GPL |
| gtk2 | 2.14.3 | LGPL |
| gtk3 | 3.10.6-1 | LGPL |
| gzip | 1.6-1 | GPL3 |
| harfbuzz | 0.9.24-1 | MIT |
| hicolor-icon-theme | 0.12-2 | GPL2 |
| hplip | 3.14.1 | custom |
| icewm | 1.3.7 | GPL |
| inputproto | 1.4.4 | MIT |
| jack | 0.121.3-7 | GPL,LGPL |
| kbproto | 1.0.3 | MIT |
| keyutils | 1.5.8-1 | GPL2,LGPL2.1 |
| kobs-ng | 12.09.01 | GPL |
| krb5 | 1.11.4-1 | custom |
| lcms2 | 2.5-2 | MIT |
| libcap | 2.22-5 | GPL2 |
| libcups | 1.7.0-2 | GPL |
| libdbus | 3.5.7 | GPL,custom |
| libdrm | 2.3.1 | MIT |
| liberation-fonts | 20070509 | GPL+exception |
| libffi | 3.0.13-4 | MIT |
| libfontenc | 1.0.4 | MIT |
| libgcrypt | 1.5.3-1 | LGPL |
| libgpg-error | 1.12-1 | LGPL |
| libICE | 1.0.4 | MIT |
| libidn | 1.28-2 | GPL3,LGPL |
| libjpeg-turbo | 1.3.0-3 | GPL,custom |
| liblzma | 5.0.5-2 | PublicDomain |
| libnfnfnetlink | 0.0.25 | GPL |
| libnl | 3.2.23-1 | GPL |
| libpciaccess | 0.10.6 | MIT |
| libpng | 1.6.7-1 | custom |
| libpthread-stubs | 0.1 | MIT |
| libSM | 1.0.2 | MIT |
| libtasn1 | 3.4-1 | GPL3,LGPL |
| libtermcap | 2.0.8 | LGPL |
| libtiff | 4.0.3-4 | custom |
| libusbx | 1.0.17-1 | LGPL |

Software License (Cont'd)

| Name | Version | License |
|---------------|----------|---------|
| libx11 | 1.6.2-1 | custom |
| libXau | 1.0.4 | MIT |
| libXaw | 1.0.4 | MIT |
| libxcb | 1.9.1-2 | custom |
| libxcomposite | 0.4.4-1 | custom |
| libxcursor | 1.1.14-1 | custom |
| libXext | 1.0.4 | MIT |
| libXfixes | 4.0.3 | MIT |
| libXfont | 1.3.3 | MIT |
| libXft | 2.1.13 | MIT |
| libxi | 1.7.2-1 | custom |
| libxinerama | 1.1.3-2 | custom |
| libxkbcommon | 0.3.2-1 | custom |
| libxkbfile | 1.0.5 | MIT |
| libxml2 | 2.6.28 | MIT |
| libXmu | 1.0.4 | MIT |
| libXpm | 3.5.7 | MIT |
| libXrandr | 1.3.0 | MIT |
| libXrender | 0.9.4 | MIT |
| libXt | 1.0.4 | MIT |
| libxtst | 1.2.2-1 | custom |
| libxxf86vm | 1.1.3-1 | custom |
| linux-gpib | 3.2.20 | GPL2 |
| linux_kernel | 3.0.35 | GPL2 |
| lua | 5.2.3-1 | MIT |
| merge | 0.1 | GPL |
| mesa | 10.0.1-1 | custom |
| mesa-libgl | 10.0.1-1 | custom |
| modeps | 1 | GPL |
| ncurses | 5.9-6 | MIT |
| nettle | 2.7.1-1 | GPL2 |
| newfs_msdos | 1.33 | BSD |
| obexftp | 0.23 | LGPL |
| openobex | 1.5 | LGPL |
| openssl | 0.9.8g | custom |
| p11-kit | 0.20.1-1 | BSD |
| pango | 1.36.1-1 | LGPL |
| pcre | 8.34-1 | BSD |
| perf | 3.0.35 | GPL |
| pixman | 0.32.4-1 | custom |
| poppler | 0.26.4-1 | GPL |

Software License (Cont'd)

| Name | Version | License |
|-------------------------|--------------|--------------------------|
| poppler-data | 0.4.6-1 | custom,GPL2 |
| poppler-qt4 | 0.26.3-1 | GPL |
| portaudio | 19_20111121- | custom |
| portmap | 5beta | BSD |
| qt4 | 4.8.2 | GPL3,LGPL, FDL,custom |
| qwt | 6.1.0rc3 | LGPL |
| randrproto | 1.2.2 | MIT |
| readline | 6.2.004-2 | GPL |
| recordproto | 1.13.2 | MIT |
| renderproto | 0.9.3 | MIT |
| resourceproto | 1.0.2 | MIT |
| samba | 3.6.23 | GPL3 |
| scrnsaverproto | 1.1.0 | MIT |
| talloc | 2.1.1-1 | GPL3 |
| tcpdump | 4.5.1-1 | BSD |
| tcp_wrappers | 7.6 | BSD |
| timezone | 2006n | BSD |
| tslib | 1 | LGPL |
| u-boot | Jan-13 | GPL |
| udev | 117 | GPL |
| wayland | 1.3.0-1 | MIT |
| wget | 1.15-1 | GPL3 |
| wireless_tools | 29 | GPL |
| wireshark | 1.12.1 | GPL2 |
| wpa_supplicant | 0.5.9 | GPL |
| x11vnc | 0.9.13-6 | GPL2 |
| xcb-protocol | 1.2 | MIT |
| xcmiscproto | 1.1.2 | MIT |
| xextproto | 7.0.3 | MIT |
| xf86bigfontproto | 1.1.2 | MIT |
| xf86driproto | 2.0.4 | MIT |
| xorg-server | 1.6.1 | MIT |
| xorg-x11-drv-keyboard | 1.3.2 | MIT |
| xorg-x11-drv-mouse | 1.4.0 | MIT |
| xorg-x11-protocol-devel | 7.5 | MIT |
| xorg-x11-xkb-utils | 7.2 | MIT |
| xproto | 7.0.13 | MIT |
| xterm | 234 | MIT |
| xtrans | 1.2.3 | MIT |
| zlib | 1.2.8 | zlib |

9.9 EULA License Document

Software End-User License Agreement (EULA)

Please read this Software End-User License Agreement (hereafter this EULA) carefully before using (includes executing, copying, registering, etc.) this software (includes programs, databases, scenarios, etc., used to operate, set, etc., Anritsu electronic equipment). By reading this EULA and using this software, you are agreeing to be bound by the terms of its contents and Anritsu Corporation (hereafter Anritsu) hereby grants you the right to use this Software with the Anritsu-specified equipment (hereafter Equipment) for the purposes set out in this EULA.

1. Grant of License and Limitations

1. Regardless of whether this Software was purchased from or provided free-of-charge by Anritsu, you agree not to rent, lease, lend, or otherwise distribute this Software to third parties and further agree not to disassemble, recompile, reverse engineer, modify, or create derivative works of this Software.
2. You may make one copy of this Software for backup purposes only.
3. You are not permitted to reverse engineer this software.
4. This EULA allows you to install one copy of this Software on one piece of Equipment.

2. Disclaimers

To the extent not prohibited by law, in no event shall Anritsu be liable for personal injury, or any incidental, special, indirect or consequential damages whatsoever, including, without limitation, damages for loss of profits, loss of data, business interruption or any other commercial damages or losses, arising out of or related to your use or inability to use this Software.

3. Limitation of Liability

- a. If a fault (bug) is discovered in this Software, preventing operation as described in the operation manual or specifications whether or not the customer uses this software as described in the manual, Anritsu shall at its own discretion, fix the bug, or exchange the software, or suggest a workaround, free-of-charge. However, notwithstanding the above, the following items shall be excluded from repair and warranty.
 - i. If this Software is deemed to be used for purposes not described in the operation manual or specifications.
 - ii. If this Software is used in conjunction with other non-Anritsu-approved software.
 - iii. Recovery of lost or damaged data.
 - iv. If this Software or the Equipment has been modified, repaired, or otherwise altered without Anritsu's prior approval.
 - v. For any other reasons out of Anritsu's direct control and responsibility, such as but not limited to, natural disasters, software virus infections, etc.
- b. Expenses incurred for transport, hotel, daily allowance, etc., for on-site repairs by Anritsu engineers necessitated by the above faults shall be borne by you.
- c. The warranty period for faults listed in article 3a above covered by this EULA shall be either 6 months from the date of purchase of this Software or 30 days

after the date of repair, whichever is longer.

4. Export Restrictions

You may not use or otherwise export or re-export directly or indirectly this Software except as authorized by Japanese and United States law. In particular, this software may not be exported or re-exported (a) into any Japanese or US embargoed countries or (b) to anyone on the Japanese or US Treasury Department's list of Specially Designated Nationals or the US Department of Commerce Denied Persons List or Entity List. By using this Software, you warrant that you are not located in any such country or on any such list. You also agree that you will not use this Software for any purposes prohibited by Japanese and US law, including, without limitation, the development, design and manufacture or production of missiles or nuclear, chemical or biological weapons of mass destruction.

5. Termination

Anritsu shall deem this EULA terminated if you violate any conditions described herein. This EULA shall also be terminated if the conditions herein cannot be continued for any good reason, such as violation of copyrights, patents, or other laws and ordinances.

6. Reparations

If Anritsu suffers any loss, financial or otherwise, due to your violation of the terms of this EULA, Anritsu shall have the right to seek proportional damages from you.

7. Responsibility after Termination

Upon termination of this EULA in accordance with item 5, you shall cease all use of this Software immediately and shall as directed by Anritsu either destroy or return this Software and any backup copies, full or partial, to Anritsu.

8. Dispute Resolution

If matters of dispute or items not covered by this EULA arise, they shall be resolved by negotiations in good faith between you and Anritsu.

9. Court of Jurisdiction

This EULA shall be interpreted in accordance with Japanese law and any disputes that cannot be resolved by negotiation described in Article 8 shall be settled by the Japanese courts.

9.10 CE Conformity Marking

Anritsu affixes the CE conformity marking on the following product(s) in accordance with the Decision 768/2008/EC to indicate that they conform to the EMC, LVD, and RoHS directive of the European Union (EU).

CE marking



9.10.1 Product Model

Model:
MT1000A Network Master Pro

9.10.2 Applied Directive

EMC:
Directive 2014/30/EU
LVD:
Directive 2014/35/EU
RoHS:
Directive 2011/65/EU

9.10.3 Applied Standards

EMC:
Emission: EN 61326-1: 2013 (Class A)
Immunity: EN 61326-1: 2013 (Table 2)

| Standard | Performance Criteria* |
|------------------------------|-----------------------|
| IEC 61000-4-2 (ESD) | B |
| IEC 61000-4-3 (EMF) | A |
| IEC 61000-4-4 (Burst) | B |
| IEC 61000-4-5 (Surge) | B |
| IEC 61000-4-6 (CRF) | A |
| IEC 61000-4-8 (RPFMF) | A |
| IEC 61000-4-11 (V dip/short) | B, C |

*: Performance Criteria

- A. The equipment shall continue to operate as intended during and after the test. No degradation of performance or loss of function is allowed below a performance level specified by the manufacturer, when the equipment is used as intended. The performance level may be replaced by a permissible loss of performance. If the minimum performance level or the permissible performance loss is not specified by the manufacturer, either of these may be derived from the product description and documentation and what the user may reasonably expect from the equipment if used as intended.
- B. The equipment shall continue to operate as intended after the test. No degradation of performance or loss of function is allowed below a performance level specified by the manufacturer, when the equipment

is used as intended. The performance level may be replaced by a permissible loss of performance. During the test, degradation of performance is however allowed. No change of actual operating state or stored data is allowed. If the minimum performance level or the permissible performance loss is not specified by the manufacturer, either of these may be derived from the product description and documentation and what the user may reasonably expect from the equipment if used as intended.

- C. Temporary loss of function is allowed, provided the function is self-recoverable or can be restored by the operation of the controls.

Harmonic current emissions:

EN 61000-3-2:2014 (Class A equipment)

LVD:

EN 61010-1:2010 (Pollution Degree 2)

RoHS:

EN 50581:2012 (Category 9)

If the third digit of the serial number is "6",
the product complies with RoHS.

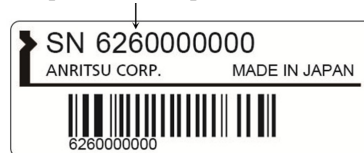



Serial number example

9.10.4 Authorized Representative

| | |
|----------------|---|
| Name: | Murray Coleman Head of Customer Service EMEA ANRITSU EMEA Ltd |
| Address, City: | 200 Capability Green, Luton Bedfordshire, LU1 3LU |
| Country: | United Kingdom |

9.10.5 CE Declaration

| | |
|--|---|
|  envision : ensure | ANRITSU CORPORATION 5-1-1 Onna, Atsugi-shi, Kanagawa, 243-8555 Japan Phone: +81 46 223 1111 |
|  | DECLARATION of CONFORMITY |
| | Product: Anritsu Corporation Model: MT1000A Serial: 6xxxxxxxxx Software name and version : Not reconfigurable radio Accessories : G0385A/G0310A |
| | This declaration of conformity is issued under the sole responsibility of the manufacturer |
| | Means of Conformity |
| | We declare under our sole responsibility that the Product (s) is conformity with the essential requirements and other relevant requirements of the Radio Equipment (RE) Directive (2014/53/EU). |
| | Supplied by |
| | Anritsu Corporation 5-1-1 Onna Atsugi-shi Kanagawa, 243-8555 Japan |
| | Technical File held by |
| | Anritsu Corporation 5-1-1 Onna Atsugi-shi Kanagawa, 243-8555 Japan |
| | Notified Body |
| | N/A N/A |
| | Standard used for comply |
| RE Directive (Article 3.1(a) Safety) | EN 60950-1: 2006 + Amd.11: 2009 + Amd.1: 2010 + Amd.12: 2011 EN 62311: 2008 |
| RE Directive (Article 3.1(b) EMC) | EN 301 489-1 V2.1.1 EN 301 489-17 V3.1.1 EN 61326-1: 2013 EN 61000-3-2: 2014 EN 61000-3-3: 2008 |
| RE Directive (Article 3.2 Spectrum) | EN 300 328 V2.1.1 |
| Date of issue: June 7, 2017 Signature of Responsible Person: | Masato Arai Director Anritsu Corporation |
|  | |
| | No. M3T-1CENMX0001 |

9.11 RCM Conformity Marking

Anritsu affixes the RCM mark on the following product(s) in accordance with the regulation to indicate that they conform to the EMC framework of Australia/New Zealand.

RCM marking



9.11.1 Product Model

Model:
MT1000A Network Master Pro

9.11.2 Applied Standards

EMC:
Emission: EN 61326-1:2013 (Class A equipment)

9.12 Laser Safety

9.12.1 Laser Safety Classifications

Class 1, 1M and 3R indicate the danger degree of the laser radiation specified below according to IEC 60825-1:2007.

Class 1:

Lasers that are safe under reasonably foreseeable conditions of operation, including the use of optical instruments for intrabeam viewing.

Class 1M:

Lasers emitting in the wavelength range from 302.5 to 4000 nm that are safe under reasonably foreseeable conditions of operation, but may be hazardous if the user employs optics within the beam. Two conditions apply:

- a. for diverging beams, if the user views the laser output with certain optical instruments (for example, eye loupes, magnifiers and microscopes) within a distance of 100 mm;
- or,
- b. for collimated beams, if the user views the laser output with certain optical instruments (for example, telescopes and binoculars).

Class 3R:

Lasers that emit in the wavelength range from 302.5 to 10^6 nm where direct intrabeam viewing is potentially hazardous but the risk is lower than for Class 3B lasers.

WARNING

Before using this instrument, always ensure that the warning light is lit when the optical output switch is turned on.

If this warning light does not turn on, the equipment may be faulty and for safety reasons should be returned to an Anritsu service center or representative for repair.

The laser in the module provided for this equipment is classified as Class 1, 1M, or 3R according to the IEC 60825-1:2007 standard.

Never use optical instruments to directly view Class 1M laser products. Doing so may result in serious damage to the eyes.

CAUTION

Use of controls or adjustments or performance of procedures other than those specified herein may result in hazardous radiation exposure.

Table 1 Laser Safety Classifications Based on IEC 60825-1:2007





| Model Name | Class | Max. Optical Output Power (mW)* | Pulse Width (s)/ Repetition Rate | Emitted Wavelength (nm) | Beam Divergence (deg) | Laser Aperture | Built-in Laser |
|--|-------|---------------------------------|----------------------------------|-------------------------|-----------------------|---|----------------|
| MU100020A | 1M | 0.15 | 20×10^{-6} / 0.019 | 1310 | 11.5 | Figure 1, [1] | Table 2 (a) |
| | 1 | 0.15 | 20×10^{-6} / 0.019 | 1550 | 11.5 | | Table 2 (b) |
| MU100021A | 1M | 0.15 | 20×10^{-6} / 0.019 | 1310 | 11.5 | Figure 2, [1] | Table 2 (a) |
| | 1 | 0.15 | 20×10^{-6} / 0.019 | 1550 | 11.5 | | Table 2 (b) |
| | 1M | 0.012 | 0.5×10^{-6} / 0.036 | 850 | 36.9 | Figure 2, [3] | Table 2 (c) |
| | 1 | 0.15 | 4×10^{-6} / 0.037 | 1300 | 36.9 | | Table 2 (d) |
| MU100022A | 1M | 0.15 | 20×10^{-6} / 0.019 | 1310 | 11.5 | Figure 3, [1] | Table 2 (a) |
| | 1 | 0.15 | 20×10^{-6} / 0.019 | 1550 | 11.5 | | Table 2 (b) |
| | 1 | 0.15 | 20×10^{-6} / 0.019 | 1625 | 11.5 | | Table 2 (f) |
| Option 002 | 3R | 0.003 | CW | 650 | 11.5 | Figure 1, [2] Figure 2, [2] Figure 3, [2] | Table 2 (e) |
| * Indicates the possible optical output power when each and every reasonably foreseeable single-fault condition is included. | | | | | | | |

Table 2 Specifications of Laser Built into MU100020A, MU100021A, and MU100022A

| | Max. Optical Output Power (mW)* | Pulse Width (s)/ Repetition Rate | Emitted Wavelength (nm) | Beam Divergence (deg) |
|--|---------------------------------|----------------------------------|-------------------------|-----------------------|
| (a) | 0.3 | 20×10^{-6} / 0.019 | 1310 | 11.5 |
| (b) | 0.3 | 20×10^{-6} / 0.019 | 1550 | 11.5 |
| (c) | 0.024 | 0.5×10^{-6} / 0.036 | 850 | 36.9 |
| (d) | 0.3 | 4×10^{-6} / 0.037 | 1300 | 36.9 |
| (e) | 0.003 | CW | 650 | 11.5 |
| (f) | 0.3 | 20×10^{-6} / 0.019 | 1625 | 11.5 |
| * Indicates the possible optical output power when each and every reasonably foreseeable single-fault condition is included. | | | | |

9.12.2 Indication Labels on Product

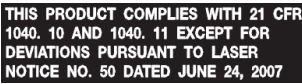
Table 3 Labels on Product

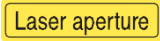
| | Type | Label | Affix to | Model Name |
|---|----------------|---|--|--|
| 1 | Explanation |  | Figure 4, A Figure 7, A | MU100020A, MU100021A, MU100022A |
| 2 | Explanation |  | Figure 4, B Figure 6, B Figure 7, B | MU100020A, MU100021A, MU100022A |
| 3 | Certification |  | Figure 4, C Figure 5, C | MU100020A, MU100021A, MU100022A |
| 4 | Identification |  | Figure 6, D | MU100020A, MU100021A, MU100022A |
| 5 | Warning |  | Figure 4, E Figure 5, E Figure 6, E Figure 7, E | MU100020A, MU100021A, MU100022A |
| 6 | Aperture |  | Figure 8, F | MU100020A, MU100021A, MU100022A with option 002 |

9.12.3 Laser Radiation Markings



Figure 1: Locations of laser aperture (MU100020A)

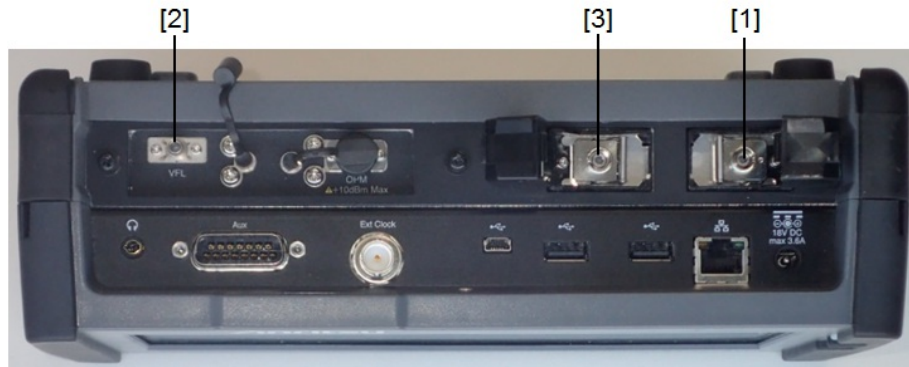

Figure 2: Locations of laser aperture (MU100021A)



Figure 3: Locations of laser aperture (MU100022A)



Figure 4: Locations of labels (MU100020A, MU100021A, MU100022A with Rear panel)



Figure 5: Locations of labels (MU100020A, MU100021A, MU100022A with MU100010A)

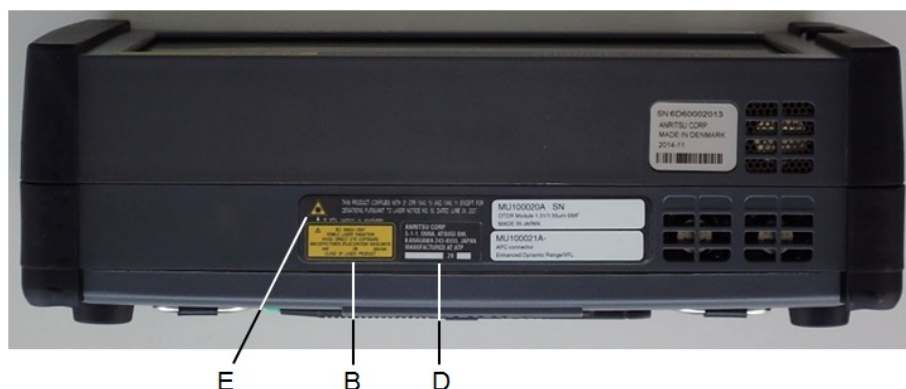

Figure 6: Locations of labels (Bottom side of MU100020A, MU100021A, MU100022A)

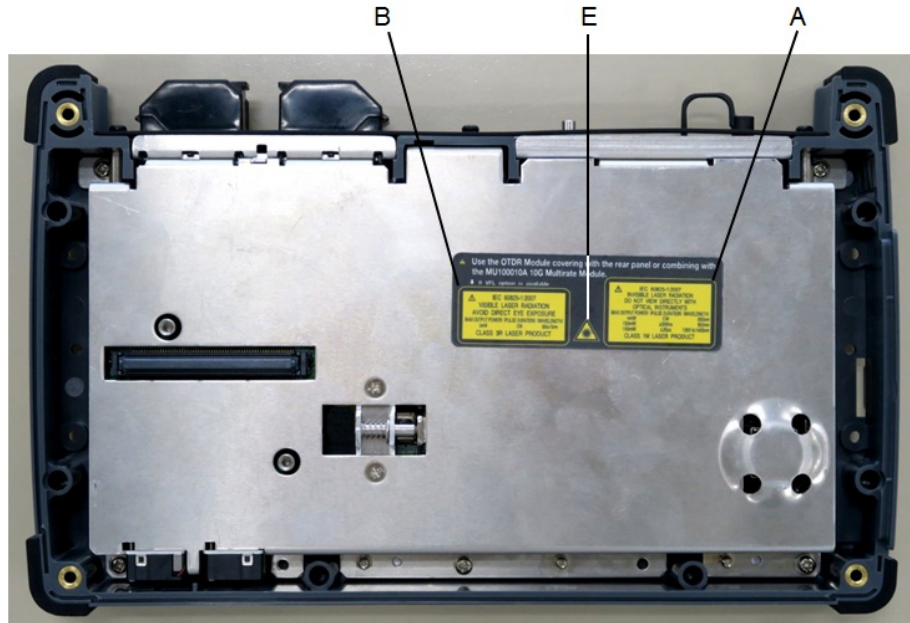

Figure 7: Locations of labels (Front side of MU100020A, MU100021A, MU100022A)



Figure 8: Location of a label (MU100020A, MU100021A, MU100022A with option 002)

9.13 Wireless Certification

9.13.1 Japan MIC



MT1000A is certified the certification of construction type of specified radio equipment.

9.13.2 North America (USA FCC and Canada IC)

This device complies with Industry Canada license-exempt RSS standard(s). Operation is subject to the following two conditions:

1. This device may not cause interference.
2. This device must accept any interference, including interference that may cause undesired operation of this device.

Le présent appareil est conforme aux CNR d'Industrie Canada applicables aux appareils radio exempts de licence. L'exploitation est autorisée aux deux conditions suivantes :

1. l'appareil ne doit pas produire de brouillage.
2. l'utilisateur de l'appareil doit accepter tout brouillage radioélectrique subi, même si le brouillage est susceptible d'en compromettre le fonctionnement.

FCC CAUTION

Changes or modifications not expressly approved by the party responsible for compliance could void the user's authority to operate the equipment.

This transmitter must not be co-located or operated in conjunction with any other antenna or transmitter.

The available scientific evidence does not show that any health problems are associated with using low power wireless devices. There is no proof, however, that these low power wireless devices are absolutely safe. Low power Wireless devices emit low levels of radio frequency energy (RF) in the microwave range while being used. Whereas high levels of RF can produce health effects (by heating tissue), exposure of low-level RF that does not produce heating effects causes no known adverse health effects. Many studies of low-level RF exposures have not found any biological effects. Some studies have suggested that some biological effects might occur, but such findings have not been confirmed by additional research. MT1000A has been tested and found to comply with FCC/IC radiation exposure limits set forth for an uncontrolled environment and meets the FCC radio frequency (RF) Exposure Guidelines and RSS-102 of the IC radio frequency (RF) Exposure rules.

Les connaissances scientifiques dont nous disposons n'ont mis en évidence aucun problème de santé associé à l'usage des appareils sans fil à faible puissance. Nous ne sommes cependant pas en mesure de prouver que ces appareils sans fil à faible puissance sont entièrement sans danger. Les appareils sans fil à faible puissance émettent une énergie radioélectrique (RF) très faible dans le spectre des micro-ondes lorsqu'ils sont utilisés. Alors qu'une dose élevée de RF peut avoir des effets sur la santé (en chauffant les tissus), l'exposition à de faibles RF qui ne produisent pas de chaleur n'a pas de mauvais effets connus sur la santé. De nombreuses études ont été menées sur les expositions aux RF faibles et n'ont découvert aucun effet biologique. Certaines études ont suggéré qu'il pouvait y avoir certains effets biologiques, mais ces résultats n'ont pas été confirmés par des recherches supplémentaires. MT1000A a été testé et jugé conforme aux limites d'exposition aux rayonnements énoncées pour un environnement non contrôlé et respecte les règles des radioélectriques (RF) de la FCC lignes directrices d'exposition et d'exposition aux fréquences radioélectriques (RF) CNR-102 de l'IC.

9.13.3 Europe CE



Hereby, Anritsu Corporation, declares that this instrument is in compliance with the essential requirements and other relevant provisions of Directive 1999/5/EC.

9.13.4 Brazil ANATEL

This equipment is certified by ANATEL in accordance with the regulated procedure by Resolution 242/2000 and meets the applicable technical requirements, including exposure limits of Specific Absorption Rate related to electric fields, magnetic and electromagnetic radio frequency, in accordance with the Resolution No. 303/2002 and 533/2009.

This device complies with the RF exposure guidelines when positioned at least 0 cm away from the body. For more information, see the website of ANATEL - www.anatel.gov.br

Este produto está homologado pela Anatel, de acordo com os procedimentos regulamentados pela Resolução n°242/2000 e atende aos requisitos técnicos aplicados, incluindo os limites de exposição da Taxa de Absorção Específica referente a campos elétricos, magnéticos e eletromagnéticos de radiofrequência, de acordo com as Resoluções n° 303/2002 e 533/2009. Este dispositivo está em conformidade com as diretrizes de exposição á radiofrequência quando posicionado a pelo menos 0 centímetros de distância do corpo. Para maiores informações, consulte o site da Anatel - www.anatel.gov.br

9.13.5 China SRRC

- 使用频率: 2.4 - 2.4835 GHz
- 等效全向辐射功率(EIRP):
天线增益 < 10 dBi 时: $\leq 100 \text{ mW}$ 或 $\leq 20 \text{ dBm}$
- 最大功率谱密度:
WLAN: 天线增益 < 10 dBi 时: $\leq 10 \text{ dBm / MHz}$ (EIRP)
Bluetooth: 天线增益 < 10 dBi 时: $\leq 20 \text{ dBm / MHz}$ (EIRP)
- 载频容限: 20 ppm
- 带外发射功率(在 2.4 - 2.4835 GHz 频段以外)
 $\leq -80 \text{ dBm / Hz}$ (EIRP)
- 杂散发射(辐射)功率(对应载波 ± 2.5 倍信道带宽以外):
 $\leq -36 \text{ dBm / 100 kHz}$ (30 - 1000 MHz)
 $\leq -33 \text{ dBm / 100 kHz}$ (2.4 - 2.4835 GHz)
 $\leq -40 \text{ dBm / 1 MHz}$ (3.4 - 3.53 GHz)
 $\leq -40 \text{ dBm / 1 MHz}$ (5.725 - 5.85 GHz)
 $\leq -30 \text{ dBm / 1 MHz}$ (其它 1 - 12.75 GHz)

不得擅自更改发射频率、加大发射功率(包括额外加装射频功率放大器), 不得擅自外接天线或改用其它发射天线;

使用时不得对各种合法的无线电通信业务产生有害干扰; 一旦发现有干扰现象时, 应立即停止使用, 并采取措施消除干扰后方可继续使用;

使用微功率无线电设备, 必须忍受各种无线电业务的干扰或工业、科学及医疗应用设备的辐射干扰;

不得在飞机和机场附近使用。

9.13.6 Indonesia SDPPI

| |
|--------------------------|
| 34837/SDPPI/2017 4679 |
|--------------------------|

MT1000A is certified SDPPI wireless certification.

9.13.7 Israel MoC

10. תנאים מיוחדים והערות המשרד:

- 10.1 היבואן ידביק תווית על גוף המכשיר ותווית נוספת על גבי אריזה חיצונית, בהן יהיה רשום:
 א. מספר אישור אלאחטי של משרד התקשורת הוא 51-43492.
 ב. אסור להחליף את האנטנה המקורית של המכשיר, ולא לעשות בו כל שינוי טכני אחר.
- 10.2 נדרש להדגיש ללקוח כי השימוש בצידוד זה היינו על פי התנאים הבאים:
 א. נקודות הגישה תהיה מיועדת אך ורק לחיבור משתמש המצוי בחצרים מתוחמים (דוגמת בית, בית עסק, מתחם שדה תעופה, קמפוס אוניברסיטאי וכו')
 ב. לצורך גישה לאינטרנט, נקודת הגישה תקושר מחוץ לחצרים אך ורק אל בעל רשיון למתן שירות גישה לאינטרנט (ISP, להלן-ספק אינטרנט). הקישור לספק אינטרנט יהיה אך ורק באמצעות קו תקשורת נתונים המסופק בידי בעל רשיון למתן שירותי תקשורת נתונים;
 ג. קישור נקודת הגישה מחוץ לחצרים לצורך תקשורת נתונים ייעשה באמצעות תשתיות של בעל רשיון מתאים ובלבד שלא ייעשה שימוש בקישור כאמור לצורך העברת קול (VOICE)
 ד. לצורך שרות לצד ג' נדרש רשיון נוסף מאגף הנדסה ורישוי (משרד התקשורת).

9.13.8 Mexico IFETEL

IFETEL certification number: RCPANMT14-0759



The operation of this equipment is subject to the following two conditions:

1. It is possible that this equipment or device may not cause harmful interference.
2. This equipment or device must accept any interference, including interference that may cause undesired operation.

La operación de este equipo está sujeta a las siguientes dos condiciones: :

1. es posible que este equipo o dispositivo no cause interferencia perjudicial.
2. este equipo o dispositivo debe aceptar cualquier interferencia, incluyendo la que pueda causar su operación no deseada.

9.13.9 Philippines NTC

MT1000A is certified NTC wireless certification.

9.13.10 Russia CU Scheme and Minsvyaz



MT1000A is certified CU scheme and Minsvyaz wireless certification.

9.13.11 Singapore IMDA

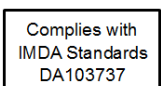

MT1000A is certified IMDA wireless certification.

9.13.12 Thailand NTC

This telecommunication equipment is in compliance with NTC requirements.

9.14 Declarations

9.14.1 Notes on Export Management

This product and its manuals may require an Export License/Approval by the Government of the product's country of origin for re-export from your country.

Before re-exporting the product or manuals, please contact us to confirm whether they are export-controlled items or not.

When you dispose of export-controlled items, the products/manuals need to be broken/shredded so as to be unlawfully used for military purposes.

9.14.2 Information for EU and EFTA Customers Only

Please recycle the battery



The product that you have purchased contains a rechargeable battery. The battery is recyclable. At the end of its useful life, under various state and local laws, it may be illegal to dispose of this battery into the municipal waste. Check with your local solid-waste disposal officials for details of recycling options or proper disposal in your area.

Before disposing of this product, discharge the battery and mail it to your Anritsu Service or Sales office.

1. Disconnect the AC adapter, if used.
2. Turn the power switch to on.
3. Leave the product on until the power indicator goes off; the battery is now discharged.
4. Remove the battery.
5. Insulate the battery terminals with adhesive tape.
6. Please recycle in accordance with your national or regional legislation.



*Equipment marked with the Crossed-out Wheeled Bin Symbol complies with council directive 2012/19/EU (the "WEEE directive") in European Union.
For products placed on the EU market after August 13, 2005, please contact your local Anritsu representative at the end of the product's useful life to arrange disposal in accordance with your initial contract and the local law.*

9.14.3 Information for U.S. Customers Only

Please recycle the battery



The product that you have purchased contains a rechargeable battery. The battery is recyclable. At the end of its useful life, under various state and local laws, it may be illegal to dispose of this battery into the municipal waste stream. Check with your local solid waste officials for details in your area for recycling options or proper disposal.

Before disposing of this product, discharge the battery and mail it to your Anritsu Service or Sales office.

1. Attach the battery pack to the product.
2. Disconnect the AC adapter, if used.
3. Turn the power switch to ON.
4. Leave the product on until the power indicator goes off; the battery is now discharged.
5. Remove the battery.
6. Insulate the battery terminals with adhesive tape.
7. Mail it to your Anritsu Service or Sales office, or to the address shown below.

ANRITSU COMPANY
490 Jarvis Drive, Morgan Hill, CA 95037-2809, USA

9.14.4 Information for the Chinese Market Only

Concerning declaration of China RoHS, please see the note below.



*China RoHS is not 100% identical to the European (EU) RoHS. EU RoHS has exemptions for Pb and Hg in various alloys, soldering, displays and other products. The China RoHS declaration in the next table does **NOT** comply with EU RoHS.*

产品中有毒有害物质或元素的名称及含量

| 部件名称 | 有毒有害物质或元素 | | | | | |
|---|-----------|-----------|-----------|-----------------|---------------|-----------------|
| | 铅 (Pb) | 汞 (Hg) | 镉 (Cd) | 六价铬 [Cr(VI)] | 多溴联苯 (PBB) | 多溴二苯醚 (PBDE) |
| 印刷线路板 (PCA) | × | ○ | × | × | ○ | ○ |
| 机壳、支架 (Chassis) | × | ○ | × | × | ○ | ○ |
| LCD | × | × | × | × | ○ | ○ |
| 其他(电缆、风扇、 连接器等) (Appended goods) | × | ○ | × | × | ○ | ○ |

○：表示该有毒有害物质在该部件所有均质材料中的含量均在 SJ/T11363-2006 标准规定的限量要求以下。
×：表示该有毒有害物质至少在该部件的某一均质材料中的含量超出 SJ/T11363-2006 标准规定的限量要求。

环保使用期限

| | |
|--|---|
| | <p>这个标记是根据 2006/2/28 公布的「电子信息产品污染控制管理办法」以及 SJ/T 11364-2006 「电子信息产品污染控制标识要求」的规定，适用于在中国销售的电子信息产品的环保使用期限。仅限于在遵守该产品的安全规范及使用注意事项的基础上，从生产日起算的该年限内，不会因产品所含有害物质的泄漏或突发性变异，而对环境污染，人身及财产产生深刻地影响。</p> <p>注) 电池的环保使用期限是 5 年。</p> |
|--|---|