



Audio 
precision

APx517
ACOUSTIC AUDIO ANALYZER

Installation Instructions
and Specifications

B Series

APx517 B Series acoustic audio analyzer

Installation Instructions and Specifications



B Series APx517 with 1/4 inch headphone connector and Bluetooth option

Copyright © 2020 Audio Precision, Inc.
All rights reserved.
Printed in the United States of America.

No part of this manual may be reproduced or transmitted in any form or by any means, electronic or mechanical, including photocopying, recording, or by any information storage and retrieval system, without permission in writing from the publisher.

Audio Precision, AP, and APx are trademarks of Audio Precision, Inc. Windows™ is a trademark of Microsoft Corporation. Dolby © Digital is a trademark of Dolby Laboratories. DTS © Digital Surround is trademark of DTS, Inc.

The *Bluetooth*® word mark and logos are registered trademarks owned by the Bluetooth SIG, Inc. and any use of such marks by Audio Precision is under license. Other trademarks and trade names are those of their respective owners.

MPEG-4 AAC-LC audio technology is licensed by Fraunhofer IIS (<https://www.iis.fraunhofer.de/de/ff/amm.html>).

Qualcomm® aptX™, aptX™ HD, and aptX™ Low Latency audio codecs are products of Qualcomm Technologies International, Ltd.

Qualcomm is a trademark of Qualcomm Incorporated, registered in the United States and other countries, used with permission. aptX is a trademark of Qualcomm Technologies International, Ltd., registered in the United States and other countries, used with permission.



Audio Precision
5750 SW Arctic Drive
Beaverton, Oregon 97005
503-627-0832
800-231-7350
ap.com

pn 8211.0372 rev 000

XX1111381774

Documentation and Support

This booklet contains safety information, installation instructions and full specifications for the Audio Precision APx517 acoustic audio analyzer.

The APx500 User's Manual

Detailed information on the operation of the APx517 acoustic audio analyzer is available from the embedded help installed with the APx500 measurement software, and in the APx500 User's Manual, included in PDF format with the analyzer. The user's manual is also available on the Web at ap.com; printed copies can be ordered from Audio Precision or your local distributor.

ap.com

Visit the Audio Precision Web site at ap.com for APx support information. APx resources are available at ap.com. You can also contact our Technical Support staff at techsupport@ap.com, or by telephoning 503-627-0832 ext. 4, or 800-231-7350 ext. 4 (toll free in the U.S.A.).



Table of Contents

Safety	7
Sécurité	9
Seguridad	13
Installation	17
Installation (Fr)	23
Instalación.	29
Abbreviations, Terms and Symbols.	33
APx517 B Series Specifications	35
DIO digital input/output module specifications.	51
DSIO digital serial input/output module specifications.	57

Bluetooth input/output module specifications	63
HDMI+ARC input/output module specifications.	65
PDM input/output module specifications	73
PDM 16 input module specifications	83

Safety

Safety Information

Do NOT service or repair this equipment unless properly qualified. Servicing should be performed only by a qualified technician or an authorized Audio Precision distributor.

Do NOT defeat the safety ground connection. This equipment is designed to operate only with an approved three-conductor power cord and safety grounding. Loss of the protective grounding connection can result in electrical shock hazard from the accessible conductive surfaces of this equipment.

Do NOT exceed mains voltage ratings. This equipment is designed to operate only from a 50–60 Hz ac mains power source at 100–240 Vac nominal voltage. The mains supply voltage is not to exceed $\pm 10\%$ of nominal (90–264 Vac).

For continued fire hazard protection, fuses should be replaced **ONLY** with the exact value and type indicated on the rear panel of the instrument and discussed on page 19 of this booklet.

The International Electrotechnical Commission (IEC 1010-1) requires that measuring circuit terminals used for voltage or current measurement be marked to indicate their Measurement Category. The Measurement Category is based on the amplitude of transient or impulse voltage that can be expected from the AC power distribution network. This product is classified as Measurement Category I, abbreviated “CAT I”. This product should not be used within Categories II, III, or IV. The APx517 measurement terminals are intended to be used for the measurement of audio signals only.

Do NOT substitute parts or make any modifications without the written approval of Audio Precision. Doing so may

Safety

create safety hazards. Using this product in a manner not specified by Audio Precision can result in a safety hazard.

This product is for indoor use—Installation Category II, Measurement Category I, pollution degree 2.

To clean the enclosure of this product, use a soft cloth or brush to remove accumulated dust. A mild detergent may be used to remove remaining dirt or stains. Do not use strong or abrasive cleaners. Wipe all surfaces with a damp cloth.

This unit is designed for rack mounting, but is also supplied with four feet that can be attached to the bottom surface for desktop use.

Safety Symbols

The following symbols may be marked on the panels or covers of equipment or modules, and are used in this manual:



WARNING!—This symbol alerts you to a potentially hazardous condition, such as the presence of dangerous voltage that could pose a risk of electrical shock. Refer to the accompanying Warning Label or Tag, and exercise extreme caution.



ATTENTION!—This symbol alerts you to important operating considerations or a potential operating condition that

could damage equipment. If you see this marked on equipment, refer to the Operator's Manual or User's Manual for precautionary instructions.



FUNCTIONAL EARTH TERMINAL—A terminal marked with this symbol is electrically connected to a reference point of a measuring circuit or output and is intended to be earthed for any functional purpose other than safety.



PROTECTIVE EARTH TERMINAL—A terminal marked with this symbol is bonded to conductive parts of the instrument and is intended to be connected to an external protective earthing system.

Disclaimer

Audio Precision cautions against using their products in a manner not specified by the manufacturer. To do otherwise may void any warranties, damage equipment, or pose a safety risk to personnel.

Sécurité

Consignes de sécurité

Ne procédez PAS à l'entretien ou à la réparation de cet équipement à moins d'être dûment qualifié(e) pour le faire. L'entretien devrait être effectué uniquement par un technicien qualifié ou un distributeur Audio Precision agréé.

Ne PAS dérouter le branchement de la mise à la terre de sécurité. Cet équipement est conçu pour être utilisé uniquement avec un cordon d'alimentation approuvé avec connecteur à trois conducteurs et mise à la terre de sécurité. La perte de connexion à la mise à la terre protectrice peut entraîner un risque de choc électrique à partir des surfaces conductrices accessibles de cet équipement.

Ne PAS dépasser la tension de réseau nominale. Cet équipement est conçu pour fonctionner uniquement à partir d'une source d'alimentation réseau de 50–60 Hz CA, à une tension nominale de 100–240 V CA. La tension d'alimenta-

tion du réseau ne doit pas dépasser $\pm 10\%$ de la tension nominale (90–264 V CA).

Pour obtenir en permanence la protection contre les risques d'incendie, les fusibles doivent être remplacés UNIQUEMENT par des fusibles de même valeur et type, comme indiqué sur le panneau arrière de l'instrument et précisé à la page 25 de ce livret.

La International Electrotechnical Commission (la Commission électrotechnique internationale) (CEI 1010-1) exige que les bornes des circuits de mesure utilisées pour la mesure de la tension ou du courant identifient leur catégorie de mesure. La catégorie de mesure se base sur l'amplitude de la tension transitoire ou de la tension d'impulsion à laquelle on peut s'attendre d'un réseau de distribution d'alimentation électrique CA. Ce produit est classé dans la catégorie de mesure I, selon l'abréviation « CAT I ». Ce produit ne devrait pas être utilisé dans les catégories II, III

ou IV. Ces bornes sont destinées à la mesure des signaux audio seulement.

Ne PAS remplacer de pièces ou effectuer de modifications sans l'approbation écrite d'Audio Precision. Si c'est le cas, il pourrait y avoir des risques pour la sécurité. Utiliser ce produit d'une manière non précisée par Audio Precision peut entraîner un risque pour la sécurité.

Ce produit est destiné à une utilisation à l'intérieur-Catégorie d'installation II, Catégorie de mesure I, degré de pollution 2.

Pour nettoyer le boîtier de ce produit, utiliser un chiffon doux ou une brosse douce permettant d'éliminer la saleté accumulée. Un détergent doux peut être utilisé pour éliminer la saleté ou les taches. Ne pas utiliser de produits nettoyants forts ou abrasifs. Essuyer toutes les surfaces à l'aide d'un chiffon humide.

Cette unité est conçue pour être fixée sur bâti, mais elle est aussi équipée de quatre pattes qui peuvent être fixées au-dessous du boîtier pour utilisation sur un bureau.

Symboles de sécurité

Les symboles suivants peuvent être présents sur les panneaux ou les couvercles de l'équipement ou des modules, et sont utilisés dans le présent manuel:



AVERTISSEMENT!—Ce symbole vous informe d'une situation potentiellement dangereuse, par exemple, la présence d'une tension dangereuse qui pourrait présenter un risque de

choc électrique. Consultez l'autocollant ou l'étiquette d'avertissement qui l'accompagne, et faites preuve d'une grande prudence.



ATTENTION!—Ce symbole vous informe d'importantes considérations liées au fonctionnement ou d'une condition d'utilisation potentielle qui pourrait endommager l'équipement. Si vous voyez ce symbole sur l'équipement, consultez le manuel de l'opérateur ou le manuel de l'utilisateur pour connaître les instructions préventives.



BORNE DE TERRE FONCTIONNELLE— Les bornes identifiées à l'aide de ce symbole sont reliées électriquement à un point de référence d'un circuit ou d'une sortie de mesure et doivent être raccordées à la terre (mise à la terre) pour toute fonction utilitaire autre que la sécurité.



BORNE DE TERRE DE PROTECTION—Les bornes identifiées à l'aide de ce symbole sont liées à des pièces conductrices de l'instrument et elles doivent être raccordées à un système protecteur de mise à la terre externe.

Avis de non-responsabilité

Audio Precision déconseille fortement l'utilisation de ses produits d'une manière non spécifiée par le fabricant. Une telle utilisation pourrait annuler toute garantie, endommager l'équipement ou présenter un risque de sécurité pour le personnel.

Seguridad

Información de seguridad

NO proporcione servicio o reparación a este equipo a menos que esté debidamente calificado. El trabajo de servicio deberá ser efectuado solamente por un técnico calificado o un distribuidor autorizado de Audio Precision.

NO modifique la conexión de seguridad a tierra. Este equipo está diseñado para operar solamente con una extensión aprobada de tres conductores puestos a tierra de seguridad. La pérdida de conexión de protección a tierra puede dar como resultado un peligro de descarga eléctrica al tocar las superficies conductoras accesibles de este equipo.

NO exceder las clasificaciones de la tensión de red eléctrica. Este equipo está diseñado para operar solamente de una fuente de suministro eléctrico de 50–60 Hz de corriente alterna a una tensión nominal de 100–240 VCA. La fuente

de suministro de voltaje no debe exceder del $\pm 10\%$ del nominal (90–264 VCA).

Para protección continua contra riesgo de incendio, los fusibles deberán reemplazarse SOLAMENTE con fusibles de valor y tipo exactos indicados en el panel posterior del instrumento y que se explica en la página 31 de este folleto.

International Electrotechnical Commission [La Comisión Electrotécnica Internacional] (IEC 1010-1) requiere que los terminales del circuito de medición que se utilizan solamente para medición de voltaje o corriente se marquen para indicar la categoría de medición. La categoría de medición se basa en la amplitud del voltaje transitorio o de impulso que se puede esperar de la red de distribución de voltaje de CA. Este producto se clasifica como Categoría de Medición I, abreviado como “CAT I”.

Este producto no deberá usarse dentro de las categorías II, III, o IV. Los terminales de medición de entrada están concebidos para usarse solamente para la medición de señales de audio.

NO reemplace partes ni haga modificaciones sin la aprobación por escrito de Audio Precision. Hacerlo podría causar riesgos de seguridad. El uso de este producto en una manera no especificada por Audio Precision puede resultar en un riesgo de seguridad.

Este producto es para uso en interiores—Categoría de instalación II, Categoría de medición I, grado de contaminación 2.

Para limpiar la caja de este producto, utilice un trapo o cepillo suave para remover el polvo acumulado. Se puede utilizar un detergente neutro para remover la suciedad o manchas remanentes. No utilice limpiadores fuertes o abrasivos. Limpie todas las superficies con un trapo húmedo.

Esta unidad está diseñada para montaje sobre un estante, pero también se suministra con cuatro patas que se pueden conectar a la superficie inferior para uso sobre un escritorio.

Símbolos de seguridad

Los siguientes símbolos podrían estar marcados en los paneles o cubiertas del equipo o los módulos, y se utilizan en este manual:



¡ADVERTENCIA!—Este símbolo le alerta sobre una condición potencialmente peligrosa, tal como la presencia de voltaje peligroso que pudiera representar un riesgo de

descarga eléctrica. Consulte la etiqueta de advertencia adjunta y tenga mucha precaución.



¡ATENCIÓN!—Este símbolo le alerta de consideraciones operativas importantes o de una condición operativa potencial que pudiera dañar al equipo. Si usted ve este símbolo en el equipo, consulte el Manual del operador o el Manual del usuario para instrucciones de precaución.



TERMINAL DE TIERRA FUNCIONAL—Un terminal marcado con este símbolo está conectado eléctricamente a un punto de referencia de un circuito de medición o salida y se supone está conectado a tierra (aterrizado) para algún fin funcional diferente a la seguridad.



TERMINAL DE TIERRA DE PROTECCIÓN—Un terminal marcado con este símbolo está enlazado a partes conductoras del instrumento y se supone que está conectado a un sistema externo de protección a tierra (aterrizada).

Exención de responsabilidad

Audio Precision advierte contra el uso de este producto de una manera no especificada por el fabricante. El hecho de no hacerlo de la manera indicada invalidaría las garantías,

causaría daño al equipo, o representaría un riesgo de seguridad para el personal.

Installation

Software

All APx systems use the same award-winning measurement software, APx500.

APx “B Series” analyzers

All analyzers shipped in late December 2018 (or afterward), including the APx517 acoustic audio analyzer, have a new embedded processor and enhanced security provisions. These analyzers are designated “B Series” and carry “B Series” nomenclature. “B Series” APx analyzers do not require an APx KeyBox (see below), but may require authorization codes to enable APx500 software or software options.

See Chapter 1 of the APx500 User’s Manual for information on the APx KeyBox and using current APx500 software with an earlier APx analyzer (non “B Series”).

PC system requirements

The APx500 measurement software requires a personal computer (PC) with the following features and capabilities:

- Operating system: Microsoft Windows 10 (64-bit).
- Intel i5 or better processor running at a clock speed of at least 2.5 GHz. AMD Processors with similar specifications are also supported.
- At least 8 GB of RAM. 16 GB is recommended.
- At least 1.5 GB of free hard disk space. An SSD for the operating system drive is highly recommended.
- A CD-ROM optical disc drive or Internet connection to download and install software.
- A USB 2.0 port or USB 3.0 port.

Installation

- A color monitor with SXGA (1280 x 1024) video graphics support. Video resolution of 1900 x 1080 or greater is recommended.

System performance is sensitive to processor speed; faster processors will yield faster results.

APx500 is data intensive and it is recommended that other data-intensive applications not be run concurrently. This includes Audio Precision's AP2700, APWIN or ATS.

Installation

To install the measurement software, insert the APx500 application disc into the optical drive on the PC and follow the instructions in the installation dialog. If you don't have the APx500 application disc, you can download APx500 from the Audio Precision Web site at ap.com.

NOTE: You must have local administrator rights to install APx500 software. Go to User Accounts in the Windows Control Panel, or check with your network administrator.

Running the software without instrument hardware attached

NOTE: You must have standard user rights or administrator rights to operate APx500 software. Guest users are not supported.

You can launch the APx500 software without instrument hardware attached. When no hardware is detected, APx500 will present you with the following dialog box:

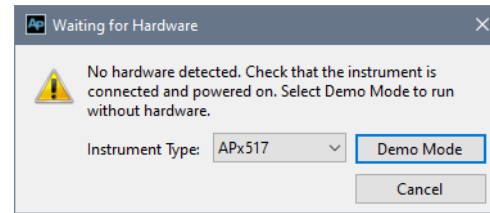

Select “Demo Mode.” APx500 will run in demo mode, which allows you to explore the user interface but does not enable any measurement functions. Input data shown in Demo Mode is false data, generated for display only.

At first launch, Demo Mode runs simulating attachment to an APx585. To run Demo Mode simulating another instrument, select that option from the Instrument Type menu.

Running the software with instrument hardware attached

NOTE: You must have standard user rights or administrator rights to operate APx500 software. Guest users are not supported.

Connecting the instrument to your PC

Before connecting your APx517 instrument to your PC, install the APx500 measurement software as described above. Connecting the instrument prior to software installation may cause Windows to select an incorrect USB driver for the instrument.

USB driver selection

The measurement software communicates with the APx517 using a USB 2.0 interconnection. Once the software is suc-

cessfully installed, connect one end of the USB cable to a USB 2.0 port on the PC, and the other end to the PC INTERFACE port on the rear of the APx517. We strongly recommend that you use the USB cable included with your instrument (AP part number CAB-APSI). We have tested other USB cables that perform poorly.

Note: Some PCs have optional USB ports on the front of the PC, or on extension brackets on the rear. In many cases these convenience ports have compromised performance due to the extra cable length within the PC. We recommend using USB ports directly connected to the PC motherboard, typically at the rear of the PC.

Connect the APx517 mains power cord to the instrument and to a source of ac mains power. See the **Mains Power and Fusing** section that follows for more information about mains connections.

Turn the instrument on by rocking the mains power switch to **ON** (|). The mains power switch is located in the power entry module on the rear of the APx517. Windows will detect the presence of the APx517 on the USB port and will open the Hardware Update Wizard to search for the correct software driver. Select “Install the software automatically.” Windows will find the Audio Precision driver software installed with APx500 and connect to the APx517.

Launch APx500 by double-clicking on the installed shortcut. With the APx517 connected, you may be asked to update the instrument firmware during the first launch of the measurement software. APx500 will start, and in a short time you will be presented with the opening screen. Refer to the APx500 User’s Manual for more information about making measurements.

The APx500 User’s Manual is available as a PDF on the APx500 Application Disc and online at ap.com; a hard-copy version can be ordered from Audio Precision or your local distributor.

Mains Power and Fusing

Connect the APx517 mains power cord to the instrument and to a source of ac mains power. Turn the APx517 on by rocking the mains power switch to **ON** (|). The mains power switch is located in the power entry module on the rear of the analyzer.

Connecting your instrument to the electrical mains supply

An APx517 must be connected to a 50–60 Hz alternating current (ac) electrical mains supply. The minimum voltage is 100 Vac; maximum voltage is 240 Vac. Use only adequately rated detachable mains power cords.

The analyzer is fitted with a universal power supply that does not require voltage configuration or change of fuse type to accept mains voltages within the specified range.

Removing and installing mains fuses

For all rated voltages, use two mains fuses of type

- 4 A T/SB (5x20 mm) 250 V.

Use only certified fuses of the appropriate specifications.

To remove the mains fuse carrier module, refer to the figures below and proceed as follows:



Figure 1



Figure 2

Remove the mains power supply cord from the connector on the power entry module, located on the APx517 rear panel. The mains fuse carrier module is part of the power entry module, below the power switch.

Insert a small screwdriver into the slot at the bottom of the power entry module as shown in figure 1, and pry open the hinged door to reveal the red mains fuse carrier module. Lift the fuse carrier module with the screwdriver as shown in Figure 2, and then pull it out of the power entry module using your fingers. The two mains fuses are loosely mounted within the fuse carrier module; take care not to let them fall.

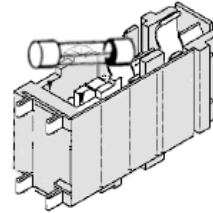

Figure 3

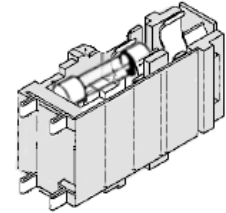

Figure 4

Replace the fuses if necessary, using fuses as described above. Note that the fuses mount between the center contact clip and the contact nearest the module pins, as shown in figure 3 and 4. Carefully reinsert the fuse carrier module into the power entry module, and press it firmly into place. Firmly close the hinged door.

Connect the power cord from a mains power outlet to the power cord connector on the APx517 rear panel.

Modular Headphone Connector Panels

The APx517 has field-swappable modular headphone output connector panels that fit in the headphone amplifier output bay. The panels are available with one of three connector types:

- 1/4 inch jack
- 3.5 mm jack
- Dual BNC

If changes in testing requirements require a different headphone connector, the headphone panel can be replaced.

Additionally, as headphone connectors wear out from the repeated plugging and unplugging of cables during production test, they can be replaced.

Removing a Modular Headphone Connector Panel

To remove the headphone connector panel from the APx517 chassis:

1. Loosen the two thumbscrews to release the connector panel from the APx517 chassis. (See Figure 5)
2. Holding the thumbscrews, pull the panel straight out from the APx517 chassis. The panel slides on a slotted rail on each side of the panel opening in the chassis.

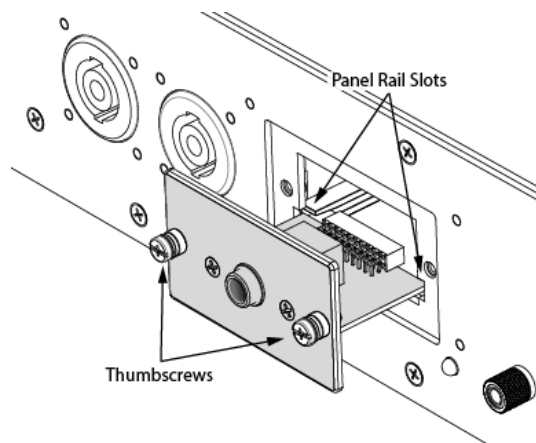

Figure 5

Installing a Modular Headphone Connector Panel

To install the headphone connector panel in the APx517 chassis:

1. Carefully remove the headphone connector panel from the protective packaging.
2. Holding the connector panel by the panel face or by the thumbscrews, align the sides of the panel with the panel rail slots on each side of the panel bay and insert the connector panel straight into the chassis. (See Figure 5)

If the connector panel does not slide in smoothly, check to ensure that the panel is inserted straight in the chassis and that the left and right edges are sliding in the panel rail slots in the panel bay.

3. Slide the panel completely into the APx517 chassis so that the panel face is flush with the chassis front panel.
4. Tighten the thumbscrews so that they hold the panel securely against the chassis.

If the thumbscrews are not secure, unplugging a headphone connector can loosen the panel connection and cause inconsistent measurement results.

Installation (Fr)

Logiciel

Tous les systèmes APx utilisent le même logiciel de mesure lauréat, soit APx500.

Analyseurs APx « B Series »

Tous les analyseurs expédiés fin décembre 2018 (et ultérieurement), y compris l'analyseur audio acoustique APx517, comptent un nouveau processeur intégré et des dispositions de sécurité améliorées. Ces analyseurs sont désignés « B Series » et portent la nomenclature « B Series ». Les analyseurs APx « B Series » ne requièrent pas un APx KeyBox (voir ci-dessous), mais peuvent requérir des codes d'autorisation pour activer le logiciel ou les options du logiciel APx500.

Voir le chapitre 1 du manuel de l'utilisateur APx500 pour en savoir plus sur l'APx KeyBox et sur l'utilisation du

logiciel APx500 actuel avec un analyseur APx antérieur (non « B Series »).

Exigences de système pour l'ordinateur personnel (PC)

Le logiciel de mesure APx500 exige un ordinateur personnel (PC) doté des caractéristiques et des capacités suivantes :

- Système d'exploitation : Microsoft Windows 10 (64 bits).
- Processeur Intel i5 ou meilleur avec une vitesse d'horloge d'au moins 2,5 GHz. Processeurs AMD avec spécifications semblables également pris en charge.
- Au moins 8 Go de mémoire vive. Recommandation : 16 Go.
- Au moins 1,5 Go d'espace libre sur le disque dur. Un disque SSD à titre de lecteur du système d'exploitation est hautement recommandé.

- Un lecteur de disque optique CD-ROM ou une connexion Internet pour télécharger et installer le logiciel.
- Un port USB 2.0 ou USB 3.0.
- Un moniteur couleur avec carte vidéo SXGA (1280 x 1024). Une résolution vidéo de 1900 x 1080 ou supérieure est recommandée.

La performance du système est sensible à la vitesse du processeur; plus les processeurs sont rapides, plus les résultats seront rapides.

L'APx500 est axé sur les données et nous recommandons que vous n'utilisiez pas d'autres applications axées sur les données en même temps, y compris les AP2700, APWIN ou ATS Audio Precision.

Installation

Pour installer le logiciel de mesure, insérez le disque de l'application APx500 dans le lecteur optique de l'ordinateur et suivez les instructions dans la fenêtre de dialogue du logiciel d'installation. Si vous n'avez pas de disque d'application APx500, vous pouvez le télécharger à partir du site web d'Audio Precision, à l'adresse ap.com.

***REMARQUE :** Vous devez détenir les droits d'administrateur local pour installer le logiciel APx500. Dans le panneau de configuration (Control Panel) de Windows, consultez les comptes d'utilisateur (User Accounts) ou consultez votre administrateur de réseau.*

Exécuter le logiciel sans brancher l'instrument

***REMARQUE :** Vous devez détenir des droits d'utilisateur standard ou des droits d'administrateur*

pour utiliser le logiciel APx500. Les utilisateurs invités ne sont pas pris en charge.

Vous pouvez exécuter le logiciel APx500 sans brancher l'instrument. Lorsqu'aucun appareil n'est détecté, APx500 présente la fenêtre de dialogue suivante :

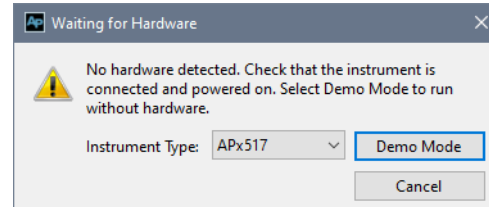

Sélectionner le « Demo Mode » (mode démo). APx500 sera exécuté en mode démo, ce qui vous permet d'explorer la surface d'utilisateur, mais pas de prendre des mesures. Les données d'entrée présentées en mode démo sont de fausses données, destinées uniquement à des fins de présentation.

Au lancement, le mode démo simule un APx585. Pour que le mode démo simule un autre instrument, sélectionnez l'option sur le menu Instrument Type (Type d'instrument).

Exécuter le logiciel avec l'instrument branché

***REMARQUE :** Vous devez détenir des droits d'utilisateur standard ou des droits d'administrateur pour utiliser le logiciel APx500. Les utilisateurs invités ne sont pas pris en charge.*

Brancher l'instrument à votre ordinateur personnel

Avant de brancher votre instrument APx517 à votre ordinateur, installez le logiciel de mesure APx500 comme

décrit plus haut. Brancher l'instrument avant d'installer le logiciel peut entraîner la sélection du mauvais pilote USB pour l'instrument.

Sélection de pilote USB

Le logiciel de mesure communique avec l'APx517 à l'aide d'une interconnexion USB 2.0. Une fois l'installation du logiciel réussie, branchez une extrémité du câble USB à un port USB 2.0 de l'ordinateur, et l'autre extrémité au port PC INTERFACE situé à l'arrière de l'APx517. Nous vous recommandons fortement d'utiliser le câble USB fourni avec votre instrument (numéro de pièce AP CAB-APSI). Nous avons testé d'autres câbles USB dont le fonctionnement est médiocre.

Remarque : Certains ordinateurs sont équipés de ports USB optionnels à l'avant, ou sur des supports de prolongation à l'arrière. Dans bien des cas, ces ports pratiques compromettent la performance étant donné la longueur de câble supplémentaire installée dans l'ordinateur. Nous vous recommandons d'utiliser les ports USB directement branchés à la carte mère de l'ordinateur, soit habituellement ceux qui sont placés à l'arrière de l'ordinateur.

Branchez le cordon d'alimentation secteur de l'APx517 à celui-ci et à une source d'alimentation secteur c.a. Voir la section **Alimentation et fusibles secteur** qui suit pour en savoir plus sur les branchements secteur.

Allumez l'instrument en basculant le bouton d'alimentation secteur en position **sous tension** (|). Le commutateur d'alimentation secteur est situé dans le module d'entrée d'alimentation, à l'arrière de l'APx517. Microsoft Windows détectera la présence de l'APx517 branché au port USB et lancera le logiciel Hardware Update Wizard qui recherchera le bon pilote logiciel à installer. Sélectionner « Install the

software automatically » (installation automatique du logiciel). Windows trouvera le logiciel pilote Audio Precision installé avec APx500 et branché à l'APx517.

Lancez APx500 en cliquant deux fois sur le raccourci. Une fois l'APx517 branché, on pourrait vous demander de mettre à jour le micrologiciel de l'instrument lors de la première exécution du logiciel de mesure. APx500 démarra et, peu de temps après, affichera l'écran d'accueil. Consultez le manuel de l'utilisateur du logiciel APx500 pour de plus amples renseignements à propos des prises de mesures.

Le manuel de l'utilisateur du logiciel APx500 est disponible en format PDF sur le disque de l'application APx500 et en ligne à l'adresse ap.com; il est possible de commander un exemplaire imprimé auprès d'Audio Precision ou de votre distributeur local.

Alimentation et fusibles secteur

Branchez le cordon d'alimentation secteur de l'APx517 à celui-ci et à une source d'alimentation secteur c.a. Allumez l'APx517 en basculant le bouton d'alimentation secteur en position **sous tension** (|). Le commutateur d'alimentation secteur est situé dans le module d'entrée d'alimentation, à l'arrière de l'analyseur.

Branchement de votre instrument à l'alimentation secteur

Un APx517 doit être branché à une alimentation secteur de courant alternatif (c.a.) de 50–60 Hz. La tension minimale est de 100 V c.a.; la tension maximale est de 240 V c.a. Utilisez des cordons d'alimentation secteur amovibles nominaux seulement.

L'analyseur est équipé d'une alimentation universelle qui n'exige pas de configuration de tension ni de changement de type de fusible pour accepter les tensions secteur à l'intérieur de la plage spécifiée.

Retirer et installer des fusibles secteur

Pour toutes les tensions nominales, utilisez deux fusibles secteur de type

- 4 A T/SB (5 x 20 mm) 250 V.

Utilisez des fusibles certifiés des spécifications appropriées seulement.

Pour retirer le module porte-fusibles secteur, consultez les figures ci-dessous et procédez comme suit :

le panneau arrière de l'APx517. Le module porte-fusibles secteur fait partie du module d'entrée d'alimentation, situé sous le commutateur d'alimentation.



Figure 1

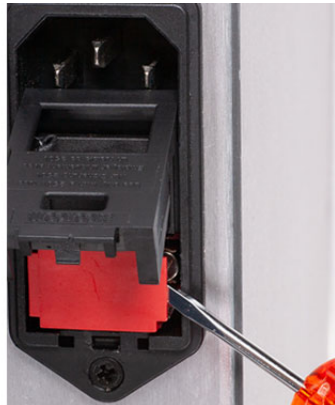

Figure 2

Retirez le cordon d'alimentation secteur du connecteur au niveau du module d'entrée d'alimentation qui est situé sur

Insérez un petit tournevis dans la fente au fond du module d'entrée de l'alimentation, comme indiqué à la figure 1, et ouvrez la porte battante pour révéler le module porte-fusibles secteur rouge. Soulevez le module porte-fusibles avec le tournevis, comme indiqué à la figure 2, et tirez-le hors du module d'entrée d'alimentation avec vos doigts. Les deux fusibles secteur sont montés de manière libre dans le module porte-fusibles; prenez soin de ne pas les laisser tomber.

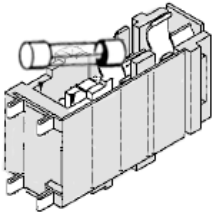

Figure 3

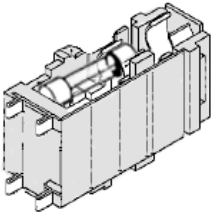

Figure 4

Remplacez les fusibles, au besoin, à l'aide de fusibles identiques à ceux décrits ci-haut. Remarquez que les fusibles s'installent entre la pièce de contact centrale et le contact le plus près des broches du module, comme indiqué aux figures 3 et 4. Réinsérez délicatement le module porte-fusibles dans le module d'entrée d'alimentation, et insérez-le fermement en position. Fermez solidement la porte battante.

Branchez le cordon d'alimentation d'une prise secteur au connecteur de cordon d'alimentation, sur le panneau arrière de l'APx517.

Instalación

Software

Todos los sistemas APx utilizan el mismo software de medición premiado, APx500.

Analizadores APx “B Series”

Todos los analizadores enviados a fines de diciembre de 2018 (o después), incluso el analizador acústico de audio APx517, tienen un nuevo procesador integrado y disposiciones de seguridad mejoradas. Estos analizadores se designan como “B Series” y llevan la nomenclatura de “B Series”. Los analizadores de “B Series” APx no requieren una APx KeyBox (ver abajo), pero pueden requerir códigos de autorización para habilitar el software APx500 o las opciones de software.

Ver el Capítulo 1 del Manual del usuario APx500 para obtener información sobre APx KeyBox y usar el software actual de APx500 con un analizador APx anterior (que no sea “B Series”).

Requisitos de sistema de la PC

El software de medición APx500 requiere una computadora personal (PC) con las siguientes características y capacidades:

- Sistema operativo: Microsoft Windows 10 (64-bit).
- Procesador Intel i5 o mejor operando a una velocidad de reloj de por lo menos 2.5 GHz. También soporta procesadores AMD con especificaciones similares.
- Por lo menos 8 GB de RAM. Se recomiendan 16 GB.
- Por lo menos 1.5 GB de espacio libre en disco duro. Se recomienda ampliamente usar un SSD para el disco duro del sistema operativo.
- Un disco óptico CD-ROM o una conexión a Internet para descargar e instalar software.
- Un puerto USB 2.0 o USB 3.0.

- Un monitor de color con soporte de gráficas de video SXGA (1280 x 1024). Se recomienda una resolución de vídeo de 1900 x 1080 o superior.

El desempeño del sistema es sensible a la velocidad del procesador: los procesadores más rápidos proporcionarán resultados más rápidos.

El APx500 tiene un alto consumo de datos y se recomienda que no se ejecuten otras aplicaciones que consumen muchos datos al mismo tiempo. Esto incluye AP2700, APWIN o ATS de Audio Precision.

Instalación

Para instalar el software de medición, inserte el disco de aplicación del APx500 dentro de la unidad óptica de la PC y siga las instrucciones en el diálogo de instalación. Si usted no tiene el disco de aplicación del APx500 [APx500 application disc], puede descargar APx500 del sitio web de Audio Precision en www.ap.com.

NOTA: Usted debe tener derechos de administrador local para instalar el software APx500. Ingrese a Cuentas de usuarios en el Panel de Control de Windows, o revise con su administrador de red.

Operación del software sin el hardware del instrumento conectado

NOTA: Usted debe tener derechos estándar de usuario o de administrador para operar el software APx500. No se permiten usuarios invitados.

Usted puede iniciar el software APx500 sin tener conectado el hardware del instrumento. Cuando no se detecta el hardware, el APx500 le mostrará el siguiente cuadro de diálogo:

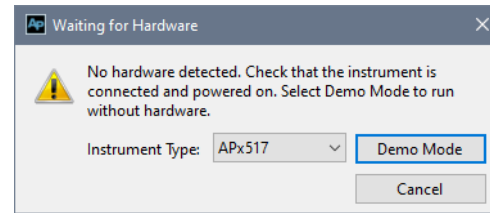

Seleccione “Demo Mode” [Modo de demostración]. El APx500 funcionará en modo de demostración, lo que le permite explorar la interfaz de usuario pero no habilita ninguna función de medición. Los datos de entrada que se muestran en el Demo Mode [Modo de demostración] son falsos, se generan solamente para fines de visualización.

Al ejecutarlo por primera vez, el Demo Mode opera simulando estar conectado a un APx585. Para operar Demo Mode simulando otro instrumento, seleccione esa opción del menú Instrument Type [Tipo de instrumento].

Operación del software con el hardware del instrumento conectado

NOTA: Usted debe tener derechos estándar de usuario o de administrador para operar el software APx500. No se permiten usuarios invitados.

Conexión del instrumento a su PC

Antes de conectar su instrumento APx517 a su PC, instale el software de medición APx500 tal como se describió anteriormente. El conectar el instrumento antes de instalar el software puede resultar en que Windows seleccione un controlador de USB incorrecto para el instrumento.

Selección del controlador del USB

El software de medición se comunica con el APx517 utilizando una interconexión USB 2.0. Una vez que el software se haya instalado correctamente, conecte un extremo del cable USB a un puerto USB 2.0 en la PC, y el otro extremo al puerto de PC INTERFACE [INTERFAZ de la PC] en la parte posterior del APx517. Recomendamos enfáticamente que use el cable USB incluido con su instrumento (AP número de parte CAB-APSI). Hemos probado otros cables USB con mal funcionamiento.

Nota: Algunas PC tienen puertos USB opcionales al frente de la PC, o en soportes de extensión en la parte posterior. En varios casos, estos puertos de conveniencia han afectado el rendimiento debido a la longitud adicional del cable dentro de la PC. Recomendamos usar puertos USB directamente conectados a la tarjeta madre de la PC, típicamente en la parte posterior de la PC.

Conecte el cable de suministro de energía del APx517 al instrumento y a una red eléctrica de CA. Vea la sección siguiente **Suministro de energía y fusibles** para obtener más información sobre conexiones a la red eléctrica.

Encienda el instrumento desplazando el interruptor de suministro de energía a **ENCENDIDO** (|). El interruptor de suministro de energía se encuentra en el módulo de entrada de energía en la parte trasera del APx517. Windows detectará la presencia del APx517 en el puerto USB y abrirá el Hardware Update Wizard [Asistente de actualización de hardware] para buscar el controlador de software correcto. Seleccione “Install the software automatically” [Instalar el software automáticamente]. Windows encontrará el software del controlador de Audio Precision instalado con APx500 y se conectará al APx517.

Ejecute APx500 haciendo doble clic en el acceso directo instalado. Con el APx517 ya conectado, se le podría pedir actualizar el firmware del instrumento durante la primera ejecución del software de medición. APx500 iniciará, y en un tiempo breve se mostrará la pantalla de inicio. Consulte el Manual del usuario del APx500 para obtener más información acerca de hacer las mediciones.

El Manual del usuario del APx500 está disponible como PDF en el Disco de Aplicación del APx500 y en línea en ap.com; además puede solicitar una versión en papel a Audio Precision o a su distribuidor local.

Suministro de energía y fusibles

Conecte el cable de suministro de energía del APx517 al instrumento y a una red eléctrica de CA. Encienda el APx517 desplazando el interruptor de suministro de energía a **ENCENDIDO** (|). El interruptor de suministro de energía se encuentra en el módulo de entrada de energía en la parte trasera del analizador.

Conexión de su instrumento a la red de energía eléctrica

El APx517 debe conectarse a una red de energía eléctrica de corriente alterna (AC) de 50-60 Hz. El voltaje mínimo es de 100 VCA, el voltaje máximo es de 240 VCA. Use solamente cables de energía para suministro desprendibles y de capacidad adecuada.

El analizador está equipado con una fuente de alimentación universal que no requiere configurar el voltaje ni cambiar el tipo de fusible para aceptar voltajes de alimentación dentro del rango especificado.

Extracción e instalación de fusibles de fuente de alimentación

Para todos los voltajes nominales, use dos fusibles de fuente de alimentación de tipo

- 4 A T/SB (5x20 mm) 250 V.

Use solamente fusibles certificados de las especificaciones apropiadas.

Para extraer los fusibles del módulo portador de fusibles de la fuente de alimentación, consulte las figuras a continuación y proceda de la siguiente manera:



Figura 1



Figura 2

Extraiga el cable de la fuente de alimentación del conector en el módulo de entrada de energía, que se localiza en el panel posterior del APx517. El módulo del portador de fusibles de la fuente de alimentación es parte del módulo de entrada de energía, abajo del interruptor de corriente.

Inserte un destornillador pequeño en la ranura en la parte inferior del módulo de entrada de energía, como se muestra en la figura 1, y abra la puerta de bisagras para que se vea el módulo portador de fusibles rojo de la fuente de alimentación. Levante el módulo portador de fusibles con el destornillador como se muestra en la figura 2, y luego sáquelo del módulo de entrada de energía usando sus dedos. Los dos fusibles de la fuente de alimentación están montados holgadamente dentro del módulo portador de fusibles, tenga cuidado de que no se caigan.



Figura 3



Figura 4

Reemplace los fusibles si es necesario, usando los fusibles que se describieron anteriormente. Tome en cuenta que los fusibles se montan entre el broche de contacto central y el contacto más cercano a los pines del módulo, como se muestra en las figuras 3 y 4. Reinserte cuidadosamente el módulo portador de fusibles dentro del módulo de entrada de energía, y presione firmemente en su lugar. Cierre firmemente la puerta de bisagras.

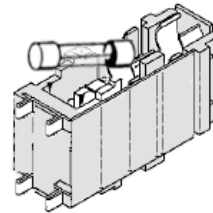
Conecte el cable de alimentación desde una toma de fuente de alimentación al conector del cable de suministro en el panel posterior del APx517.

Abbreviations, Terms and Symbols

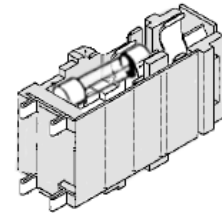
used in the following specifications

ADC or A/D	Analog to Digital converter or conversion.
BW	Bandwidth or Measurement Bandwidth, nominally at -3 dB; a single number indicates only the upper limit.
DAC or D/A	Digital to Analog converter or conversion.
DSP	Digital Signal Processing or Digital Signal Processor.
DUT	Device Under Test, the device to which the generator or analyzer is connected.
EMC	Electro-Magnetic Compatibility, usually refers to both emissions (radiated and conducted via AC mains) and susceptibility.
ENBW	Equivalent Noise Bandwidth, the frequency of an ideal filter having the same rms response to white noise.
FFT	Fast Fourier Transform, a mathematical process converting a signal in the time domain to the frequency domain.
IMD	Inter-Modulation Distortion, a measure of non-linearity using a test signal with two or more components.
RMS or rms	Root Mean Square, an equivalent-power expression of signal amplitude.
SR	Sample Rate, usually as it applies to the conversion rate of A/D and D/A converters or digital audio formats.
THD	Total Harmonic Distortion, rms summation of d2 to d9 (may be bandwidth limited), usually derived from an FFT.
THD+N	Rms measurement of ALL harmonics, spurious signals, and noise within a specified bandwidth.
Typical or Typ	A characteristic that is not guaranteed, usually due to a practical limitation in testing or metrology.
UI	Unit Interval, a measure of time as it applies to digital audio formats. 1 UI= 1/(128 • SR)
[]	Indicates a specification in an equivalent unit, for example: 0.030 dB [0.35%] or 10.61 Vrms [30.00 Vpp].
≈	Indicates an approximate or nominal value, or range of values; not guaranteed.

APx517 B Series acoustic audio analyzer Specifications

with APx500 v6.0.1 or higher measurement software
October 28, 2020 NP0020.00045 rev. 000

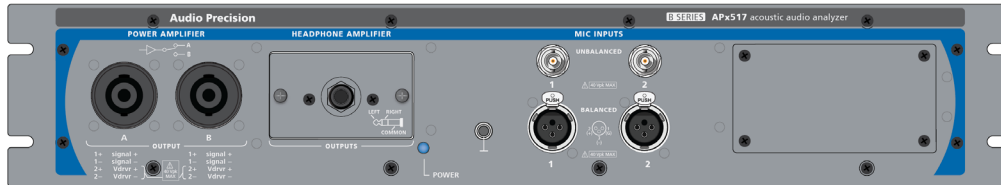

This illustration shows an APx517 B Series with the 1/4 inch headphone jack.

These specifications cover the analog input, power amplifier output, headphone amplifier output, and General and Environmental specifications of the APx517 B Series analyzer.

The APx517 has a headphone amplifier connector panel bay that can accept one of three connector panels: 1/4 inch, 3.5 mm, and Dual BNC.

Specifications for the available interface modules, including DIO, DSIO, HDMI, PDM, and Bluetooth, are found in other sections of this document.

Specification begin on the next page.

Characteristic

Specifications

Supplemental Information

Power Amplifier			
Number of Channels	1		
Waveforms	Sine, sine+DC offset, continuously swept-sine, noise, IMD test signals, multi-tone, wave file playback		
Maximum Output Ratings			
	Rload ≥ 8 Ω	17.0 Vrms	
	Rload = 2 Ω to 8 Ω	35 W, 20 Hz to 20 kHz	<i>Power output thermally limited, no maximum load power enforced. Higher maximum ambient and elevations will limit continuous power output.</i>
Output Impedance	450 mΩ max		<i>≈250 mΩ (100 mΩ current sense resistor in series with the negative output terminal)</i>
Sine Characteristics			
	Frequency Range (Fs)	2 Hz to 80.1 kHz	<i>Setting resolution is typically 45 μHz</i>
	Frequency Accuracy	±(0.0003% + 100 μHz)	
	Amplitude Range	0 to 17.00 Vrms [48.08 Vpp]	<i>8 Ω load</i>
	Amplitude Accuracy, 1 kHz	±0.08 dB [±0.93%]	
	Flatness (1 kHz ref)		
	10 Hz to 20 kHz	±0.20 dB	<i>Typically < 0.010 dB</i>
	20 kHz to 50 kHz	±0.80 dB	
	Residual THD+N {notes 1,2}		
	Fs = 20 Hz-20 kHz	≤ (-80 dB + 30 μV), 20 Hz to 20 kHz BW	

Characteristic	Specifications	Supplemental Information
----------------	----------------	--------------------------

	Non-Harmonic Content		<i>Typically < -100 dB, 20 Hz to 20 kHz</i>
	DC Offset Range	±3.00 Vdc unbalanced	<i>DC offset limits maximum ac signal</i>
	Residual DC Offset	+/-5 mV	<i>typically < 650 uV</i>
Noise Characteristics			
	Shape	White or Pink (5 Hz to 86.4 kHz), IEC 60268-1, or BS EN 50332-1	
	Amplitude Range	0 to 48.08 Vpp	<i>Amplitude calibration is approximate</i>
Residual Noise {Note 2}			
	20 Hz to 20 kHz BW	≤ 30 uVrms [-88.8 dBu]	
IMD Test Signals			
	<u>SMPTE & MOD</u>		
	Lower Frequency (LF)	40 Hz to 1.00 kHz	<i>LF tone must be ≤ 1/6 * HF tone</i>
	SMPTE Upper Frequency (HF)	2.00 kHz to 60.00 kHz	
	MOD Upper Frequency (HF)	240 Hz to 60.00 kHz	
	Mix Ratio (LF:HF)	10:1, 4:1, or 1:1	
	Amplitude Range	0 to 48.08 Vpp	
	Amplitude Accuracy	±0.06 dB [±0.70%]	
	Residual IMD {notes 1,2,3}	≤ 0.020% [-74 dB], 4:1 mix ratio	
	<u>DFD & CCIF</u>		
	Difference Frequency (Fdiff)	80 Hz to 2.00 kHz	<i>Fdiff = F2 - F1 Fmean must be ≥ 6*Fdiff</i>
	Mean Frequency (Fmean)	250 Hz to 60.00 kHz	<i>Fmean = (F1 + F2)/2</i>

Characteristic	Specifications	Supplemental Information
	Amplitude Range	0 to 48.08 Vpp
	Amplitude Accuracy	± 0.06 dB [$\pm 0.70\%$]
	Residual IMD {notes 1,2,3}	$\leq 0.010\%$ [-80 dB]
Multi-tone, Wave File Playback		
	Sample Rate Range (SR)	8 kS/s to 108 kS/s, and 175 kS/s to 192 kS/s <i>Operation from 109 kS/s to 175 kS/s is possible, but with degraded flatness</i>
	Maximum File Size	256 Msample
	Amplitude Range	0 to 48.08 Vpp <i>".Wav" file must peak at digital full scale to obtain selected amplitude</i>
	Flatness (1 kHz ref)	
	SR = 175 kS/s to 192 kS/sec	<i>Typically < 0.012 dB to 20 kHz</i>
	SR = 8 kS/s to 108 kS/s	<i>Typically < 0.04 dB to 20 kHz; max frequency limited to $\approx 0.45 * SR$</i>
	Spurious Content	<i>Typically < -100 dB, 20 Hz to 20 kHz</i>
	Output Equalization	Arbitrary 30-pole output filter
Impedance Measurement		
	Accuracy	$\leq 1\%$ for resistive loads 4 Ω to 16 Ω , 20 Hz to 20 kHz $\leq 2\%$ for resistive load 2 Ω to 4 Ω , 20 Hz to 20 kHz
Vdriver Maximum Input Voltage		
	Balanced	40 Vpk (80 Vpp), differentially
	Maximum Output Current	6.0 Apk 35 W into 2 Ω

Characteristic

Specifications

Supplemental Information

<u>Headphone Amplifier</u>		
Number of Channels	2, independent amplitude control	
Waveforms	Sine, split frequency sine, split phase sine, sine+DC offset, continuously swept-sine, noise, IMD test signals, multi-tone, wave file playback	
Maximum Output Ratings		
Rload ≥ 800 Ω	9.0 Vrms	
Rload = 2 Ω to 800 Ω	100 mW, 20 Hz to 20 kHz	<i>Power output thermally limited, no maximum load power enforced.</i>
Output Impedance	500 mΩ Max	<i>≈ 275 mΩ, typical</i>
Sine Characteristics		
Frequency Range (Fs)	2 Hz to 80.1 kHz	<i>Setting resolution is typically 45 μHz</i>
Frequency Accuracy	±(0.0003% + 100 μHz)	
Amplitude Range	0 to 9.000 Vrms [25.456 Vpp]	<i>800 Ω load</i>
Amplitude Accuracy, 1 kHz	±0.05 dB [±0.58%]	
Flatness (1 kHz ref)		
10 Hz to 20 kHz	±0.08 dB	<i>Typically <0.02 dB</i>
20 kHz to 50 kHz	±0.15 dB	
50 kHz to 80 kHz	±0.40 dB	
Residual THD+N {notes 1,2}		
2 Ω load Fs = 20 Hz-20 kHz	≤ (-84 dB + 15 μV), 20 Hz to 20 kHz	
800 Ω load Fs = 20 Hz-20 kHz	≤ (-90 dB + 15 μV), 20 Hz to 20 kHz	
Non-Harmonic Content		<i>Typically < -125 dB, 20 Hz to 20 kHz</i>

Characteristic	Specifications	Supplemental Information
----------------	----------------	--------------------------

	Phase Offset Range (Split Phase)	< 1.0 deg	<i>DC coupling, to 80.1 kHz</i>
	DC Offset Range	±3.00 Vdc unbalanced	<i>DC offset limits maximum ac signal</i>
	Residual DC Offset	+/-5.0 mV	<i>Amplifier set to 0V, typical < 1 mV</i>
Noise Characteristics			
	Shape	White or Pink (5 Hz to 86.4 kHz), IEC 60268-1, or BS EN 50332-1	
	Amplitude Range	0 to 25.456 Vpp	<i>Amplitude calibration is approximate</i>
Residual Noise {Note 2}			
	20 to 20 kHz BW	≤ 15 uVrms [-97.8 dBu]	
IMD Test Signals			
	<u>SMPTE & MOD</u>		
	Lower Frequency (LF)	40 Hz to 1.00 kHz	<i>LF tone must be ≤ 1/6 * HF tone</i>
	SMPTE Upper Frequency (HF)	2.00 kHz to 60.00 kHz	
	MOD Upper Frequency (HF)	240 Hz to 60.00 kHz	
	Mix Ratio (LF:HF)	10:1, 4:1, or 1:1	
	Amplitude Range	0 to 25.456 Vpp	
	Amplitude Accuracy	±0.08 dB [±0.70%]	
	Residual IMD {notes 1,2,3}	≤ 0.032% [-70 dB], 4:1 mix ratio	

Characteristic	Specifications	Supplemental Information
----------------	----------------	--------------------------

	DFD & CCIF		
	Difference Frequency (Fdiff)	80 Hz to 2.00 kHz	$F_{diff} = F_2 - F_1 $ <i>Fmean must be $\geq 6 * F_{diff}$</i>
	Mean Frequency (Fmean)	250 Hz to 60.00 kHz	$F_{mean} = (F_1 + F_2)/2$
	Amplitude Range	0 to 25.456 Vpp	
	Amplitude Accuracy	± 0.06 dB [$\pm 0.70\%$]	
	Residual IMD {notes 1,2,3}	$\leq 0.010\%$ [-80 dB]	
Multi-tone, Wave File Playback			
	Sample Rate Range (SR)	8 kS/s to 108 kS/s, and 175 kS/s to 192 kS/s	<i>Operation from 109 kS/s to 175 kS/s is possible, but with degraded flatness</i>
	Maximum File Size	256 Msample	
	Amplitude Range	0 to 25.456 Vpp	<i>".Wav" file must peak at digital full scale to obtain selected amplitude</i>
	Flatness (1 kHz ref)		
	SR = 175 kS/s to 192 kS/sec		<i>Typically < 0.012 dB to 20 kHz</i>
	SR = 8 kS/s to 108 kS/s		<i>Typically < 0.04 dB to 20 kHz; max frequency limited to $\approx 0.45 * SR$</i>
	Spurious Content		<i>Typically < -110 dB 20 Hz to 20 kHz</i>
	Output Equalization	Arbitrary 30-pole output filter	
Impedance Measurement			
	Accuracy	$\leq 1\%$ for resistive loads < 350 Ω , 20 Hz to 20 kHz $\leq 1\%$ for resistive load 350 Ω to 800 Ω , 20 Hz to 6 kHz $\leq 3\%$ for resistive loads 350 Ω to 800 Ω , 6 kHz to 20 kHz	

Characteristic	Specifications	Supplemental Information
Maximum Output Current	316 mApk	100 mW into 2 Ω
Typical Output Related Crosstalk {note 1}	\leq (-50 dB + 1 μ V) 5 Hz to 20 kHz	<i>Crosstalk limited on Headphone Connector Modules with shared ground (1/4" and 3.5 mm). For best crosstalk performance, Dual BNC Headphone Connector Module is recommended.</i>
<u>Mic Inputs</u>		
Number and Types of Inputs		
Balanced Microphone	2 each, female XLR, mic power independently selectable per channel	<i>Switchable +48 V phantom power through 6.81 kΩ compliant with IEC 61938:2018</i>
Unbalanced Microphone	2 each, ground sense, mic power independently selectable per channel	<i>Switchable 4 mA/10 mA (+24 V CCP) with TEDS reading capability or DC Bias 0.1 V to 12 V with 7.5 kΩ series resistor</i>
Maximum Rated Input		
Balanced	40 Vpk (80 Vpp), differentially	
Unbalanced	40 Vpk (80 Vpp)	<i>When CC 4 mA and 10 mA mic power is enabled, signal levels must be below +30 Vpk, AC+DC.</i>
Input Impedance {Note 4}		
Balanced, pin2 or pin 3 to pin 1 ground		\approx 100 k Ω \approx 230 pF
Unbalanced		\approx 100 k Ω \approx 230 pF
Input AC Coupling	Independently selected per channel	<i>Time constant \approx0.20 sec; -3 dB at \approx0.8 Hz</i>
Number of Channels	2, independently auto-ranging	<i>Max ADC sample rate = 192 kS/s</i>
Input Ranges	354 mVpk to 35.36 Vpk (250 mVrms to 25 Vrms), 10 dB steps	<i>Maximum ac signal is \approx25 Vac rms unbal. 25 Vac rms bal, in the 25V range</i>

Characteristic	Specifications	Supplemental Information
----------------	----------------	--------------------------

Common Mode Rejection {Note 4}		<i>Max common mode signal range:</i>
250mV, 800mV, 2.5V ranges	≥ 80 dB, 5 Hz to 5 kHz; ≥ 70 dB, 5 kHz to 20 kHz	±6 Vpk
8V range	≥ 50 dB, 5 Hz to 20 kHz	±9 Vpk
25V range	≥ 50 dB, 5 Hz to 20 kHz	±60 Vpk
Input Related Crosstalk	≤ (-120 dB + 0.3 μV) 5 Hz to 20 kHz	$R_s \leq 600\Omega$
Level (Amplitude) Measurement		
Range		
Balanced or bridging input	< 1 μV to 25 Vrms differential	
Unbalanced input	< 1 μV to 25 Vrms	
Accuracy (1 kHz)	±0.05 dB [±0.60%]	
Flatness (1 kHz ref, DC coupling)		
10 Hz to 20 kHz	±0.010 dB	<i>Typically < 0.005 dB</i>
20 kHz to 50 kHz	±0.030 dB	
50 kHz to 80 kHz	+0.10 dB, -0.6 dB	
Residual Noise (inputs shorted)	≤ 1.9 μVrms, 20 Hz to 20 kHz BW	<i>Typically < 12 nV/√Hz at 1 kHz</i>
THD+N Measurement		
Fundamental Range	5 Hz to 80.1 kHz	
Measurement Range	0 to 100%	
Accuracy	±0.5 dB	
Residual THD+N {notes 1,2}		
20 Hz-20 kHz fundamentals	≤ (-98 dB + 1.9 μV), 20 Hz to 20 kHz BW	

Characteristic

Specifications

Supplemental Information

Bandwidth Limiting Filters			
	High-pass {note 6}		
	DC	DC coupling	
	AC (<10 Hz)	AC coupling	Response is 2-pole via a combination of analog and digital filters, and is typically -3 dB at 4.1 Hz
	Butterworth	FHP (-3 dB) = 10 Hz to 90 kHz, 4-pole	
	Elliptic	FHP (-0.01 dB) = 10 Hz to 90 kHz, 5-pole; 0.01 dB pass-band ripple; ≤ -60 dB stop-band	
	Low-pass {note 5, 6}		
	ADC Pass-band	No filter is implemented, bandwidth and response are limited by the A/D and sample rate (SR)	-3 dB at $\approx 0.490 \cdot SR$, except for 192 kHz sample rate, -3 dB $\approx 0.432 \cdot SR$
	20k (AES17), 40k (AES17)	Special filters conforming with AES17	
	Butterworth	FLP (-3 dB) = 10 Hz to 90 kHz, 8-pole	ENBW $\approx 1.006 \cdot FLP$
	Elliptic	FLP (-0.01 dB) = 10 Hz to 90 kHz, 8-pole; 0.01 dB pass-band ripple; ≤ -60 dB stop-band	ENBW $\approx (1.012-1.062) \cdot FLP$ (varies due to warping)
	Weighting	A-wt, B-wt, C-wt, CCIR-1k, CCIR-2k, CCITT, C-message, 50 μ s or 75 μ s de-emph (with and without A-wt), or None	Weighting filter is cascaded with both high-pass and low-pass filters
Input Equalization		Arbitrary 30-pole input filter	<i>The EQ operates on any selected Mic Inputs input channels.</i>

Characteristic

Specifications

Supplemental Information

IMD Measurement			
	Test Signal Compatibility		
	SMPTE & MOD	Any combination of 40 Hz - 1 kHz (LF) and 240 Hz-60 kHz (HF) tones, mixed in any ratio from 1:1 to 10:1 (LF:HF)	<i>LF tone must be $\leq 1/6 * HF$ tone</i>
	DFD & CCIF	Any two-tone combination with mean frequency of 250 Hz-60 kHz and a difference frequency of 80 Hz-2.0 kHz	$F_{mean} = (F1 + F2)/2$; $F_{diff} = F2 - F1 $ <i>Fmean must be $\geq 6 * F_{diff}$</i>
	IMD Measured		
	SMPTE	Amplitude modulation of HF tone	<i>Measurement BW is ≈ 40-750 Hz</i>
	MOD	d2, d3, d2+d3, or d2+d3+d4+d5	<i>Use "d2+d3" for measurements per IEC-60268</i>
	DFD	d2, d3, d2+d3, or d2+d3+d4+d5	<i>Use "d2+d3" for measurements per IEC-60268</i>
	CCIF	d2 only	<i>"CCIF" is an archaic form of DFD that measures only the d2 product. CCIF uses a different 0 dB reference giving readings 2x higher than DFD</i>
	Measurement Range	0 to 20%	
	Accuracy	± 0.5 dB	
	Residual IMD {notes 1,2,3}		
	SMPTE & MOD	≤ -90 dB [0.0032%], 4:1 mix ratio	
	DFD	≤ -100 dB [0.0010%]	

Characteristic**Specifications****Supplemental Information**

Frequency Measurement		
Range	< 5 Hz to 90 kHz	
Accuracy	$\pm(0.0003\% + 100 \mu\text{Hz})$	<i>Vin must be $\geq 5 \text{ mV}$</i>
Resolution	6 digits	
Phase Measurement		
Ranges	-90 to +270, ± 180 , or 0 to 360 deg	
Accuracy	± 0.2 deg, 5 Hz to 5 kHz; ± 0.8 deg, 5 kHz to 20 kHz; ± 2.0 deg, 20 kHz to 50 kHz	<i>Vin must be $\geq 5 \text{ mV}$ with DC coupling, both channels. Accuracy degrades below 50 Hz with AC coupling</i>
Resolution	0.001 deg	
DC Voltage Measurement		
Input Ranges	0.25 V to 25 V, 10 dB steps	$\pm 40 \text{ Vdc}$ maximum in 25 V range.
Accuracy		
250 mV and 800 mV ranges	$\pm(0.7\% \text{ reading} + 1 \text{ mV})$	
2.5 V-8 V ranges	$\pm(0.7\% \text{ reading} + 0.1\% \text{ range})$	
Normal Mode Rejection		<i>Typically > 90 dB, 20 Hz to 20 kHz</i>

Characteristic

Specifications

Supplemental Information

<u>GENERAL / ENVIRONMENTAL</u>		
Power Requirements		100, 120, 230, or 240 Vac, 50 - 60 Hz, with safety ground via approved power cord, 400 VA max
Temperature Range		
	Operating	0 °C to +40 °C
	Storage	-40 °C to +75 °C
Humidity		90% to +40 °C (non-condensing)
Max Operating Altitude		2,000 m
Stabilization Time		20 minutes
EMC		Complies with EC Council Directives (EMC) Directive 2014/30/EU EN 61326-1:2013 Class B FCC 15.107:2020 Class B FCC 15.109:2020 Class B FCC 15.109(g):2020 Class B ICES-003:2016 updated 2017 and 2019 Class B FOR BT EQUIPPED 2014/53/EU (RED) EN 300 328 V2.2.2:2019-07 EN 301 489-17 V3.1.1:2017 FCC 15.247:2020 FCC 15.207:2020 RSS-247:2017 LP0002:2020 CNS 13438:2006 (Complete) Class B

	Safety		<p>Low Voltage Directive (LVD) (2014/35/EU) UL61010-1/CSA C22.2 No. 61010-1, Safety Requirements for Electrical Equipment for Measurement, Control, and Laboratory Use</p> <p>IEC 61010-1: 2010 (3rd Edition)/AMD:2016, Electrical Equipment for Measurement, Control, and Laboratory Use</p> <p>EN 61010-1: 2010 (3rd Edition) Corr 7-31-2011, Electrical Equipment for Measurement, Control, and Laboratory Use</p> <p>UL61010-2-030/CSA C22.2 No. 61010-2-030, Particular Requirements for Equipment Having Testing or Measuring Circuits</p> <p>IEC 61010-2-030, 2nd Edition, Rev. January 12, 2017, Particular Requirements for Equipment Having Testing or Measuring Circuits</p> <p>EN 61010-2-030:2010/COR1:2011, Particular Requirements for Equipment Having Testing or Measuring Circuits</p>
	Dimensions		
	Width		482.6 mm [19.00 inches]
	Height		87.4 mm [3.44 inches]
	Depth		455.7 mm [17.94 inches]

Characteristic	Specifications	Supplemental Information
----------------	----------------	--------------------------

Weight		5.9 kg [13 lbs]
Notes to Specifications		
1	Specification are for Power and Headphone Amplifiers only and Mic Inputs only. System specifications are typically amplifier limited.	
2	Amplifier dc offset must be off or set to ≤ 10 mV.	
3	Mic inputs must be ≥ 150 mV for specified performance. Mic Inputs set to measure "d2+d3" IMD products for MOD and DFD modes.	
4	Valid for the balanced input configuration with DC coupling only. With AC coupling, specified performance is invalid below 50 Hz.	
5	Maximum low-pass filter frequency is limited by Mic Inputs' bandwidth setting.	
6	Filter response is relative to "no filter" selection; overall system performance will also include analog flatness imperfections.	

DIO digital input/output module specifications

with APx500 v5.0 or higher measurement software
as fitted in APx52x and 58x B Series audio analyzers
NP0020.00037 rev 000
December, 2018

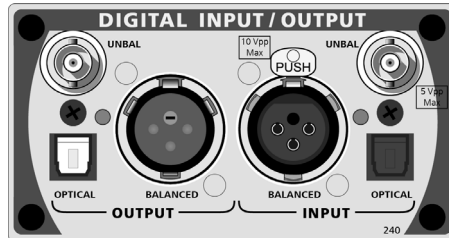

This illustration shows an APx DIO module, model 240.

These specifications cover the digital input and output functions of the Audio Precision DIO. The DIO is available as a stand-alone module (models 240).

The APx DIO provides balanced digital input and output compatible with AES3, AES/EBU and IEC60958-4, on XLR connectors; unbalanced digital input and output compatible with S/PDIF and IEC60958-3 and also AES3id and SMPTE 276 M, on BNC connectors; and optical digital input and output compatible with Toslink interfaces.

DIO specifications begin on the next page.

Characteristic

Specifications

Supplemental Information

DIGITAL I/O		
DIGITAL OUTPUT RELATED:		
Formats		
Electrical, unbalanced	SPDIF-EIAJ per IEC60958	
Electrical, balanced	AES-EBU per AES3-1992	
Optical	Toslink® or equivalent	
Sample Rate (SR) Range		
Electrical	27 kS/s to 200 kS/s	<i>Usable over the extended range of 16 kS/s to 216 kS/s with degraded waveform fidelity, accuracy, and jitter</i>
Optical	27 kS/s to 108 kS/s	
Sample Rate (SR) Accuracy		
±0.0003% [3 PPM]		
Channel Status Bits		
Full implementation per IEC-60958, automatically set, all channels same		
User Bits and Validity Flag		
Fully settable		
Residual Jitter¹		
Electrical		<i>Typically <1.5 ns</i>
Optical		<i>Typically <2.5 ns, SR ≤96 kS/s</i>
EMBEDDED OUTPUT SIGNAL RELATED:		
Waveforms	Sine, sine split frequency, sine split phase, sine+DC offset, continuously swept-sine, square-wave, noise, IMD signals, multi-tone, constant value, walking ones/zeros, bittest random, wave file playback	<i>8–24 bit word width, triangular PDF dither</i>

Characteristic Specifications Supplemental Information

Sine Characteristics		
Frequency Range	5 Hz to 0.499 • SR	
Flatness ¹		<i>Typically < 0.001 dB</i>
Offset Range	To maximum digital code [$\pm 1D$]	<i>Offset limits maximum ac signal</i>
Harmonics & Spurious ¹		<i>Typically < -140 dBFS</i>
Square Characteristics		
Frequency Range (Fq)	10 Hz to SR / 6	<i>Fq must equal SR / N where N is an even integer ≥ 6.</i>
Even Harmonic, Spurious Content		<i>Typically < -140 dBFS</i>
Noise Characteristics		
Shape	White (<5 Hz to 0.499 • SR), Pink (<10 Hz to 0.45 • SR), IEC 60268-1 or BS EN 50332-1	IEC 60268-1 is shaped pink noise. BS EN 50332-1 is similar, but with soft clipping to limit crest factor to ≈ 2 .
IMD Test Signals		
<u>SMPTE & MOD</u>		
Lower Frequency (LF)	40 Hz to 1.00 kHz	<i>LF tone must be $\leq 1/6 \cdot HF$ tone.</i>
SMPTE Upper Frequency (HF)	2 kHz to (0.499 • SR) or 60 kHz, whichever is lower	
MOD Upper Frequency (HF)	240 Hz to (0.499 • SR) or 60 kHz, whichever is lower	
Mix Ratio (LF:HF)	10:1, 4:1 or 1:1	
Residual IMD ¹		<i>Typically < -140 dBFS</i>
<u>DFD & CCIF</u>		
Difference Frequency (Fdiff)	80 Hz to 2.0 kHz	$F_{mean} = (F1 + F2)/2$
Mean Frequency (Fmean)	2.5 kHz to (0.499 • SR - Fdiff / 2) or 60 kHz, whichever is lower	$F_{diff} = F2-F1 $; F_{mean} must be $\geq 6 \cdot Fdiff$
Residual IMD ¹		<i>Typically < -150 dBFS</i>

Characteristic	Specifications	Supplemental Information
Multitone, Wave File Playback		
Sample Rate (SR)	8 kS/s to 216 kS/s	
Maximum File Size	32 MSample	
Flatness (1 kHz ref)		Typically <0.001 dB to 0.499*SR
Spurious Content		Typically <-140 dBFS
DIGITAL INPUT RELATED:		
Formats		
Unbalanced	SPDIF-EIAJ per IEC 60958, ≤5 Vpp	Input typically 75 Ω or ≈8.3 kΩ
Balanced	AES-EBU per AES3-2003, ≤10 Vpp	Input typically 110 Ω or ≈2.5 kΩ
Optical	Toslink® or equivalent	
Sample Rate (SR) Range		
Electrical	27 kS/s to 216 kS/s	Usable over the extended range of 16 kS/s to 216 kS/s with degraded waveform fidelity, accuracy, and jitter
Optical	27 kS/s to 108 kS/s	
SR Measurement Accuracy	±0.0003% [±3 ppm]	
EMBEDDED INPUT SIGNAL RELATED:		
Level (Amplitude) Measurement		
Measurement Range	< -120 dBFS to +3 dBFS	
Accuracy (1 kHz)		Typically < 0.001 dB
Flatness		Typically < 0.001 dB
Residual Noise		Typically < -140 dBFS
THD+N Measurement		
Fundamental Range	5 Hz to 0.49 • SR or 50 kHz, whichever is lower	Tuning can be set to track measured frequency, generator setting or fixed
Measurement Range	0 to 100%	
Accuracy	±0.5 dB	
Residual THD+N ²		Typically < -140 dBFS

Characteristic Specifications Supplemental Information

Bandwidth Limiting Filters (audio signals)			
	High-Pass ⁴		
	DC	DC coupling	
	AC (<10 Hz)	AC coupling	-3 dB at 4.1 Hz
	Butterworth	F _{HP} (-3 dB) = 10 Hz to 100 kHz, 4-pole	
	Elliptic	F _{HP} (-0.01 dB) = 10 Hz to 100 kHz, 5-pole; 0.01 dB pass-band ripple; ≤-60 dB stop-band	
	Low-Pass ⁴		
	FS/2	No filter is implemented, bandwidth and response are limited by the SR	
	Butterworth	F _{LP} (-3 dB) = 10 Hz to 100 kHz, 8-pole	ENBW ≈ 1.006 • F _{LP}
	Elliptic	F _{LP} (-0.01 dB) = 10 Hz to 100 kHz, 8-pole; 0.01 dB pass-band ripple; ≤ -60 dB stop-band.	ENBW ≈ (1.012–1.062) • F _{LP} (varies due to warping)
	Weighting	A-wt, B-wt, C-wt, CCIR-1k, CCIR-2k, CCITT, C-message, 50 μs or 75 μs de-emph (with and without A-wt), or None	Weighting filter is cascaded with the high-pass and low-pass bandwidth limit- ing filters.
Input Equalization		Arbitrary 30-pole input filter	The EQ operates on any selected ana- lyzer input channels.
IMD Measurement			
	Test Signal Compatibility		
	SMPTE & MOD	Any combination of 40 Hz–1 kHz (LF) and 240 Hz–60 kHz (HF), mixed in any ratio from 1:1 to 10:1 (LF:HF)	LF tone must be ≤1/6 • HF tone.
	DFD & CCIF	Any two-tone combination with mean frequency of 250 kHz–60 kHz and a difference frequency of 80 Hz–2.0 kHz	$F_{mean} = (F1 + F2)/2$ $F_{diff} = F2 - F1 $ F _{mean} must be ≥ 6 • F _{diff}

	IMD Measured		
	SMPTE	Amplitude modulation of HF tone	<i>Measurement BW is ≈40–750 Hz</i>
	MOD	d2, d3, d2+d3, or d2+d3+d4+d5	<i>Use “d2+d3” for measurements per IEC-60268</i>
	DFD	d2, d3, d2+d3, or d2+d3+d4+d5	<i>Use “d2+d3” for measurements per IEC-60268</i>
	CCIF	d2 only	<i>“CCIF” is an archaic form of DFD that measures only the d2 product. CCIF uses a different 0 dB reference giving readings 2x higher than DFD.</i>
	Measurement Range	0 to 20%	
	Accuracy	±0.5 dB	
	Residual IMD ²		
	SMPTE & MOD		<i>Typically < –140 dBFS</i>
	DFD		<i>Typically < –150 dBFS</i>
Frequency Measurement			
	Range	< 5 Hz to 0.499 • SR	
	Accuracy	±(0.0003% + 100 μHz)	
Phase Measurement			
	Ranges	–90 to +270, ±180, or 0 to 360 deg	
	Accuracy		<i>Typically < 0.001 deg</i>
NOTES to SPECIFICATIONS:			
	1	Sample rate (SR) must be ≥27 kS/s for specified performance. Jitter analyzer set for 700 Hz high-pass response per AES3-1992.	
	2	Digital generator word width must be set to 24 bits for specified performance; shorter word widths may degrade performance.	
	3	Maximum low-pass filter frequency is limited by input sample rate (SR).	
	4	DSP warping may significantly increase roll-off rate and lower ENBW.	

DSIO digital serial input/output module specifications

with APx500 v5.0 or higher measurement software
 as fitted in APx52x, 555, and 58x B Series audio analyzers
 NP0020.00034 rev 001
 March, 2020

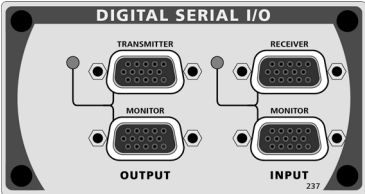

This illustration shows an APx DSIO module, model 237.

These specifications cover the digital serial input and output functions of the Audio Precision DSIO. The DSIO is available as a stand-alone module (model 237).

The Digital Serial Input/Output (or DSIO) option provides a flexible chip- or board-level serial input and output interface. With separate Master Clock, Bit Clock, Frame Clock, Channel Clock and four Data lines, variable signal formats, variable word width, bit depth and synchronization options, the DSIO can address almost any serial interface need.

Formats include TDM, I²S, DSP (bit-wide pulse) and custom formats. Up to 16 channels can be transmitted and received using the TDM format.

DSIO specifications begin on the next page.

Characteristic

Specifications

Supplemental Information

Functional characteristics		
Channels		
1 data line, TDM	1, 2, 4, 6, 8 or 16	<i>Time division multiplexing (TDM)</i>
Multiple data lines	1, 2, 4, 6 or 8	<i>up to 4 data lines; 2 channels on each line by TDM</i>
Data formats	I ² S, DSP, custom (left/right justified, one bit/one subframe/50% duty cycle frame, inverted or normal frame, optionally 1-bit left-shifted frame). All modes LSB or MSB first	
Word width	8–128 bits	<i>cannot be less than bit depth</i>
Bit depth (data length)	8–32 bits	
Sample rate (frame rate)	4 kS/s–432 kS/s	<i>1, 2, 4, 6 or 8 channels²</i>
	4 kS/s–216 kS/s	<i>16 channels²</i>
Master Clock range	4 kHz–56 MHz	<i>Actual clock rate is dependent upon bit clock, word width, and sample rate settings.</i>
Logic voltage levels	1.8 V, 2.5 V, 3.3 V	

Characteristic Specifications Supplemental Information

DC characteristics, no load			
1.8 volt setting			
	High level input		
	Minimum	1.0 V	
	Low level input		
	Maximum	0.8 V	
	High level output		
	Minimum	1.6 V	
	Low level output		
	Maximum	0.1 V	
	Absolute range		
	Minimum	-0.5 V	
	Maximum	5.5 V	
2.5 volt setting			
	High level input		
	Minimum	1.4 V	
	Low level input		
	Maximum	1.1 V	
	High level output		
	Minimum	2.2 V	
	Low level output		
	Maximum	0.1 V	
	Absolute range		
	Minimum	-0.5 V	
	Maximum	5.5 V	

Characteristic	Specifications	Supplemental Information
3.3 volt setting		
High level input		
Minimum	1.8 V	
Low level input		
Maximum	1.5 V	
High level output		
Minimum	3.0 V	
Low level output		
Maximum	0.1 V	
Absolute range		
Minimum	-0.5 V	
Maximum	5.5 V	
Input/Output impedance		
All Outputs	50 Ω , nominal	
All Inputs	10 k Ω , nominal	
AC characteristics		
Clock frequencies, input or output		
Master clock	4 kHz–56 MHz	<i>Actual clock rate is dependent upon bit clock, word width, and sample rate settings.</i>
Bit clock	4 kHz–56 MHz maximum	<i>Actual clock rate is dependent upon word width and sample rate settings.</i>
Frame	432 kHz maximum	
Output latency		
Frame		<i>typ 3 ns referenced to Bit clock</i>
Data 1–4		<i>typ 3 ns referenced to Bit clock</i>
Monitor ports		<i>typ 10 ns referenced to Signal pin</i>
Input setup and hold requirements		
Frame, setup		<i>6 ns referenced to Bit clock</i>
Frame, hold		<i>2 ns referenced to Bit clock</i>
Data 1–4, setup		<i>6 ns referenced to Bit clock</i>
Data 1–4, hold		<i>2 ns referenced to Bit clock</i>

Characteristic Specifications Supplemental Information

Clock Jitter (Advanced Master Clock required)		
Jitter Measurement		
Range	0 to 650 ns	
Detection	Peak, RMS, or Average	<i>"Average" detection is recommended for jitter response measurements.</i>
Bandwidth		
Low Limit	50 Hz or 700 Hz	
High Limit	Variable from 1 kHz to 150 kHz in 0.1 kHz steps, Butterworth or Elliptic response	
Accuracy (1 kHz)	±(1% + 300 ps)	<i>"Average" detection</i>
Flatness ¹	±0.2 dB, 100 Hz to 100 kHz	
Residual Jitter ¹		
700 Hz to 100 kHz BW	≤600 ps	
Jitter Spectrum ¹		<i>Spurious products are typically -40 dBc (below jitter signal) or -60 dBUI, whichever is larger.³</i>
Induced Jitter		
Waveforms	Sine, Square, Noise	
Signals Affected	Master Clk, Bit Clk, Frame Clock and Data	
Sine Wave Jitter		
Frequency Range (F _J)	2 Hz to 200 kHz	
Amplitude Range	0 to 1591 ns for F _J ≤ 20 kHz, derating linearly with frequency to 159.1 ns at 200 kHz	<i>Equivalent to 0 to 9.775 UI at 48 kHz sample rate, derating to 0.9775 UI.³</i>
Amplitude Resolution	100 ps	
Accuracy (1 kHz)	±0.01%	
Flatness	±0.01%	
Jitter Spectrum ¹		<i>Spurious products are typically -40 dBc (below jitter signal) or -60 dBUI, whichever is larger.³</i>
Square Wave and Noise Waveform Jitter		<i>Jitter amplitude limited to 40 ns maximum.</i>

Characteristic

Specifications

Supplemental Information

NOTES to SPECIFICATIONS

1	System specification including contributions from both generator and analyzer subject to the following condition: Bit Clock \geq 192 kHz.
2	In TDM, channel count can limit the bit clock rate.
3	For Digital Serial (DSIO), the Unit Interval (UI) is defined as $1/f_b$, where f_b is the bitclock rate in hertz.

Bluetooth input/output module specifications

with APx500 v5.0 or higher measurement software
as fitted in APx52x, 555 and 58x B Series audio analyzers
NP0020.00044 rev 000
December, 2018

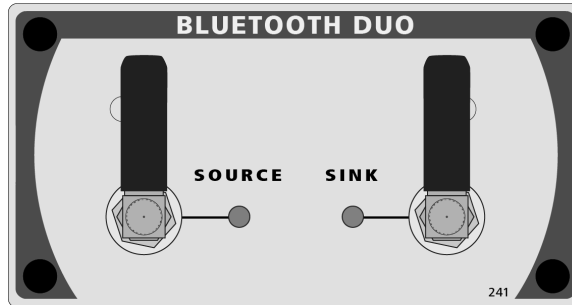

This illustration shows the Bluetooth Duo module, model 241.

These specifications cover the digital input and output functions of the Audio Precision Bluetooth Duo interface.

Bluetooth[®] is a short-distance (a few meters) control, data, and audio communications wireless technology. Bluetooth uses low power, frequency-hopping radio in the 2.4 GHz band. Communication is two-way (for handshaking, metadata, etc); some profiles (HFP, for example) support duplex audio (both directions simultaneously); some profiles (A2DP) support only simplex audio (one direction per connection). Audio Precision supports several audio-specific Bluetooth profiles for audio test.

See acknowledgements on the copyright page at the front of the booklet.

Bluetooth specifications begin on the next page.

Characteristic

Specifications

Supplemental Information

Characteristic	Specifications	Supplemental Information
Bluetooth Core Version	4.2	
Profiles/Roles, versions		
	A2DP Source/Sink 1.3	
	AVRCP Controller/Target 1.4	
	HFP Hands-Free 1.7	
	HFP Audio Gateway 1.7	
	HSP Headset/Audio Gateway 1.2	
A2DP Codecs		
	SBC	
	aptX	
	aptX Low Latency	
	aptX HD	
	AAC	
HFP Codecs		
	CVSD	
	mSBC	
RF Connections, Source and Sink		
	SMA x2	
RF Input Impedance		Typically 50 Ω
RF Output Impedance		Typically 50 Ω
RF Power		Typically 0 dBm
		Typical maximum +8 dBm
RF Sensitivity (0.1% BER)		Typically ≤ -81 dBm

HDMI+ARC input/output module specifications

with APx500 v5.0 or higher measurement software
 as fitted in APx52x, 555 and 58x B Series audio analyzers
 NP0020.00033 rev 000
 December, 2018

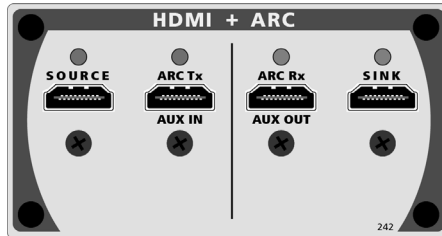

This illustration shows the HDMI+ARC module, model 242.

These specifications cover the input and output functions of the Audio Precision HDMI+ARC (High Definition Multimedia Interface plus Audio Return Channel) I/O module. HDMI+ARC is available as a stand-alone module, model 242.

The model HDMI+ARC module is fully compatible with HDMI 1.3a; additionally, it supports a subset of HDMI 1.4a, the ARC (Audio Return Channel) feature. HDMI EDID 1.4 is supported, and CEC communications on the Source and Sink connectors is supported. Go to Help > About in APx500 to check feature availability.

HDMI is designed to carry high-bandwidth digital streams providing an audio/video interface that includes content protection and a bi-directional channel for interaction with connected electronic devices. ARC (Audio Return Channel) provides an additional digital audio channel, which can simplify interface cabling in certain applications, for user convenience.

HDMI+ARC specifications begin on the next page.

Characteristic

Specifications

Supplemental Information

Revision	1.3a + ARC.	<i>ARC (Audio Return Channel) implemented per HDMI 1.4a</i>
Device Connections		
SOURCE	Typically connects to the sink input of a DUT.	<i>The video is an internally generated single color screen or the signal applied to the AUX IN connector. The audio is internally generated: see "Embedded Output Signal Related" under "DIGITAL I/O" for typical waveforms and parameters.</i>
ARC Tx / AUX IN	<p>HDMI ARC Tx configuration: Typically connects to an HDMI source that accepts ARC audio.</p> <p>HDMI Source configuration: typically connects to an external source of video to be included in the Source output signal.</p>	<p><i>Generates and transmits audio across ARC, per HDMI 1.4a. HDMI source should not transmit video.</i></p> <p><i>Incoming audio is ignored. Incoming video is passed to HDMI Source in "pass through" mode.</i></p>
ARC Rx / AUX OUT	<p>HDMI ARC Rx configuration: Typically connects to an HDMI sink that produces ARC audio.</p> <p>HDMI Sink configuration: Typically connects to an independent monitoring device.</p>	<p><i>HDMI ARC Rx configuration: Receives and analyzes audio across ARC, per HDMI 1.4a. No video is transmitted.</i></p> <p><i>HDMI Sink configuration: Contains video and audio sent to Sink input.</i></p>
SINK	Typically connects to the source output of a DUT.	<i>The embedded and encoded audio signal components are recovered for analysis.</i>
Hardware Interface	HDMI Type A	
EDID	256-byte EEPROM on both Sink and ARC TX / AUX IN connectors.	

Characteristic	Specifications	Supplemental Information
CEC (ARC connectors)	HDMI ARC Tx configuration: ARC CEC implementation per HDMI 1.4a. HDMI ARC Rx configuration: ARC CEC implementation per HDMI 1.4a.	<i>ARC link can be negotiated or forced on.</i> <i>User can manually send a CEC ping or arbitrary CEC message to any of the standard logical addresses. An indicator confirms the receipt of an ACK (acknowledged) message from the messaged device.</i>
CEC (HDMI Sink, Source Connectors)	HDMI Source configuration: CEC implementation per HDMI 1.4a. Also, user-selectable CEC pass-through from AUX IN to Source. HDMI Sink configuration: CEC implementation per HDMI 1.4a. Also, user-selectable CEC pass-through from Sink to AUX OUT.	<i>User can manually send a CEC ping or arbitrary CEC message to any of the standard logical addresses. An indicator confirms the receipt of an ACK (acknowledged) message from the messaged device.</i>
Color Support	24-bit, 30-bit, 36-bit (Deep Color)	
Max Video Rate	1080p	
ARC DIGITAL I/O		
<i>ARC DIGITAL OUTPUT RELATED:</i>		
Formats		
Signal level, single mode	0.5 Vpp typical	<i>Output R is 55 Ω typical.</i>
Signal level, common mode	0.4 Vpp typical	<i>Output R is 30 Ω typical.</i>
Sample Rate (SR) Range	27 kS/s–200 kS/s	<i>Usable over the extended range of 16 kS/s to 216 kS/s with degraded waveform fidelity, accuracy, and jitter</i>
Sample Rate (SR) Accuracy	±0.0003% [3 PPM]	
Channel Status Bits	Full implementation per IEC60958	<i>Automatically set or manual override, hex or plain English.</i>
User Bits	Fully settable	<i>Hex.</i>
Validity Flag	Set to 0, all channels	
Residual Jitter^{1,2}		<i><1.0 ns typical</i>

Characteristic	Specifications	Supplemental Information
----------------	----------------	--------------------------

EMBEDDED OUTPUT SIGNAL RELATED:		
Waveforms	Sine, sine split frequency, sine split phase, sine+DC offset, continuously swept-sine, square-wave, noise, IMD signals, multi-tone, constant value, walking ones/zeros, bittest random, wave file playback.	8–24 bit word width, triangular PDF dither.
Sine Characteristics		
Frequency Range	5 Hz to $0.499 \cdot SR$	
Flatness ¹		Typically < 0.001 dB
Harmonics & Spurious Products ^{1, 3}		Typically < -140 dBFS
Square Characteristics		
Frequency Range (Fq)	10 Hz to $SR / 6$	Only specific values are allowed: $Fq = SR / N$ where N is an even integer ≥ 6
Even Harmonic, Spurious Content		Typically < -140 dBFS
Noise Characteristics		
Shape	White (<5 Hz to $0.499 \cdot SR$), Pink (<10 Hz to $0.45 \cdot SR$), IEC 60268-1 or BS EN 50332-1	
IMD Test Signals		
SMPTE & MOD		
Lower Frequency (LF)	40 Hz to 1.00 kHz	LF tone must be $\leq 1/6 \cdot HF$ tone.
SMPTE Upper Frequency (HF)	2 kHz to $(0.499 \cdot SR)$ or 60 kHz, whichever is lower	
MOD Upper Frequency (HF)	240 Hz to $(0.499 \cdot SR)$ or 60 kHz, whichever is lower	
Mix Ratio (LF:HF)	10:1, 4:1 or 1:1	
Residual IMD ¹		Typically < -140 dBFS

Characteristic	Specifications	Supplemental Information
DFD & CCIF		
Difference Frequency (F _{diff})	80 Hz to 2.0 kHz	$F_{mean} = (F1 + F2)/2$
Mean Frequency (F _{mean})	2.5 kHz to (0.499 • SR – F _{diff} / 2) or 60 kHz, whichever is lower	$F_{diff} = F2 - F1 $; <i>F_{mean} must be ≥ 6 • F_{diff}</i>
Residual IMD ^{1, 3}		<i>Typically < –150 dBFS</i>
DIGITAL INPUT RELATED:		
Formats		
Single mode	≤1.5 Vpp	<i>Input R is nominally 55 Ω</i>
Dual mode	≤1.5 Vpp	<i>Input R is nominally 30 Ω</i>
Sample Rate Range	22 kS/s–216 kS/s	<i>Typically locks down to 16 kS/s</i>
EMBEDDED INPUT SIGNAL RELATED:		
Level (Amplitude) Measurement		
Measurement Range	< –120 dBFS to +3 dBFS	
Accuracy (1 kHz)		<i>Typically < 0.001 dB</i>
Flatness ¹		<i>Typically < 0.001 dB</i>
Residual Noise		<i>Typically < –140 dBFS</i>
THD+N Measurement		
Fundamental Range	5 Hz to 0.49 • SR or 50 kHz, whichever is lower	<i>Tuning can be set to track measured frequency, generator setting or fixed</i>
Measurement Range	0 to 100%	
Accuracy	±0.5 dB	
Residual THD+N ^{1, 3}		<i>Typically < –140 dBFS</i>
Bandwidth Limiting Filters		
High-Pass⁴		
DC	DC coupling	
AC (<10 Hz)	AC coupling	<i>–3 dB at 4.1 Hz</i>
Butterworth	F _{HP} (–3 dB) = 10 Hz to 100 kHz, 4-pole	
Elliptic	F _{HP} (–0.01 dB) = 10 Hz to 100 kHz, 5-pole; 0.01 dB pass-band ripple; ≤–60 dB stop-band	

Characteristic	Specifications	Supplemental Information
Low-Pass ⁴		
FS/2	No filter is implemented, bandwidth and response are limited by the SR	
Butterworth	F_{LP} (-3 dB) = 10 Hz to 100 kHz, 8-pole	$ENBW \approx 1.006 \cdot F_{LP}$
Elliptic	F_{LP} (-0.01 dB) = 10 Hz to 100 kHz, 8-pole; 0.01 dB pass-band ripple; ≤ -60 dB stop-band.	$ENBW \approx (1.012-1.062) \cdot F_{LP}$ (varies due to warping)
Weighting	A-wt, B-wt, C-wt, CCIR-1k, CCIR-2k, CCITT, C-message, 50 μ s or 75 μ s de-emph (with and without A-wt), or None	Weighting filter is cascaded with the high-pass and low-pass bandwidth limiting filters.
Input Equalization	Arbitrary 30-pole input filter	The EQ operates on any selected analyzer input channels.
IMD Measurement		
Test Signal Compatibility		
SMPTE & MOD	Any combination of 40 Hz–1 kHz (LF) and 240 Hz–60 kHz (HF), mixed in any ratio from 1:1 to 10:1 (LF:HF)	LF tone must be $\leq 1/6 \cdot$ HF tone.
DFD & CCIF	Any two-tone combination with mean frequency of 250 kHz–60 kHz and a difference frequency of 80 Hz–2.0 kHz	$F_{mean} = (F1 + F2)/2$ $F_{diff} = F2 - F1 $ F_{mean} must be $\geq 6 \cdot F_{diff}$.
IMD Measured		
SMPTE	Amplitude modulation of HF tone.	Measurement BW is typ. 40–750 Hz.
MOD	d2, d3, d2+d3, or d2+d3+d4+d5	Use “d2+d3” for measurements per IEC-60268.
DFD	d2, d3, d2+d3, or d2+d3+d4+d5	Use “d2+d3” for measurements per IEC-60268.
CCIF	d2 only	“CCIF” is an archaic form of DFD that measures only the d2 product. CCIF uses a different 0 dB reference giving readings 2x higher than DFD.

Characteristic	Specifications	Supplemental Information
----------------	----------------	--------------------------

	Measurement Range	0 to 20%	
	Accuracy	±0.5 dB	
	Residual IMD ^{1, 3}		
	SMPTE & MOD		Typically < -140 dBFS
	DFD		Typically < -150 dBFS
Frequency Measurement			
	Range	< 5 Hz to 0.499 • SR	
	Accuracy	±(0.0003% + 100 µHz)	
	Resolution	6 digits	
Phase Measurement			
	Ranges	-90 to +270, ±180, or 0 to 360 deg	
	Accuracy ¹		Typically < 0.001 deg
	Resolution	0.001 deg	
Notes to Specifications			
1.	System specification including contributions from both generator and analyzer. Generator-only and analyzer-only contributions are typically less.		
2.	Sample rate (SR) must be ≥ 27 kHz for specified performance. Jitter analyzer set for 700 Hz highpass response per AES3-1992.		
3.	Digital generator word width must be set to 24 bits for specified performance; shorter word widths may degrade performance.		
4.	DSP warping may significantly increase roll-off rate and lower ENBW.		

PDM input/output module specifications

with APx500 v5.0 or higher measurement software
 as fitted in APx52x, 555 and 58x B Series audio analyzers
 NP0020.00036 rev 002
 March 2020

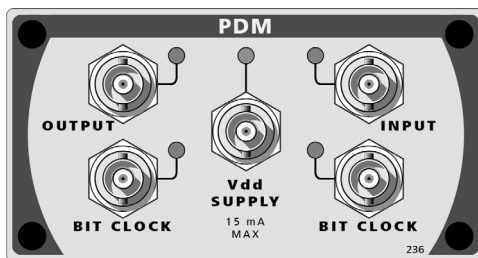

This illustration shows the PDM module, model 236.

The PDM option provides a complete solution for addressing circuits or devices with a PDM input or output. The PDM signal output consists of an APx generator audio signal, interpolated by a broad choice of oversampling ratios, and modulated into a 1-bit PDM bitstream. A 4th-order modulator is the default; a 5th-order modulator can be selected. The PDM Option also provides a signal input with its associated clock connection. The input accepts a 1-bit PDM bitstream, which is then decimated by one of a wide range of decimation ratios and filtered into baseband audio at the Decimated Rate. The input bitstream can also be analyzed directly (before decimation) in the Signal Analyzer to view out-of-band components.

These specifications cover the digital input and output functions of the Audio Precision PDM interface for the current version, model 236.

PDM specifications begin on the next page.

Technical Specifications

Parameter	Symbol	Test Conditions	Min	Typ	Max	Unit
TRANSMITTER						
Decimated Rate	F_S		4		216	kHz
Bit Clock Rate	F_B	Master or slave mode	0.128		24.576	MHz
INTERPOLATION FILTER						
Interpolation Ratio (F_B/F_S)	INTR	16, 16.67, 21.33, 24, 25, 32, 33.33, 37.5, 42.67, 48, 50, 62.5, 64, 66.67, 75, 85.33, 96, 100, 125, 128, 150, 192, 200, 250, 256, 300, 384, 400, 500, 512, 600, 768, 800	16		800	
Passband Frequency Range			0		0.45	F_S
Passband Gain		INTR = 64, 128, 256, 512	-0.0001		+0.0001	dB
		INTR = 32	-0.01		+0.01	dB
		All other INTR	-0.0063		+0.0001	dB
Stopband Frequency Range			0.55		INTR / 2	F_S
Stopband Attenuation		INTR = 32, 64, 128, 256, 512	115			dB
		All other INTR	100			dB
MODULATOR: GENERAL						
Passband Frequency Range			0		0.45	F_S
Passband Gain			-0.0001		+0.0001	dB
Maximum Input Level	MIL				0	dBFS
		-100 dBFS to MIL (order 4, 5)	-0.010		+0.001	dB
		MIL to 0 dBFS (order 4)	-0.010		+0.002	dB
Linearity		MIL to 0 dBFS (order 5)	-0.010		+0.001	dB
			99.94	100		%
Ones Density at Full Scale						
MODULATOR: ORDER 4, 64x OSR						
Overload Point	OLP	1 kHz			-7.8	dBFS

Parameter	Symbol	Test Conditions	Min	Typ	Max	Unit
Total Harm. Dist. + Noise		@OLP; BW = 0.45 F _S			-105	dB
Signal-to-Noise Ratio	SNR	@OLP; BW = 0.45 F _S	106			dB
Dynamic Range	DNR	@MIL; F _S = 48 kHz; per AES17	115			dB
MODULATOR: ORDER 5, 64x OSR						
Overload Point	OLP	1 kHz			-9.4	dBFS
Total Harm. Dist. + Noise		@OLP; BW = 0.45 F _S			-116	dB
Signal-to-Noise Ratio	SNR	@OLP; BW = 0.45 F _S	116			dB
Dynamic Range	DNR	@MIL; F _S = 48 kHz; per AES17	125			dB
MODULATOR: ORDER 4, 128x OSR						
Overload Point	OLP	1 kHz			-7.9	dBFS
Total Harm. Dist. + Noise		@OLP; BW = 0.45 F _S			-127	dB
Signal-to-Noise Ratio	SNR	@OLP; BW = 0.45 F _S	127			dB
Dynamic Range	DNR	@MIL; F _S = 48 kHz; per AES17	135			dB
MODULATOR: ORDER 5, 128x OSR						
Overload Point	OLP	1 kHz			-9.6	dBFS
Total Harm. Dist. + Noise		@OLP; BW = 0.45 F _S			-127	dB
Signal-to-Noise Ratio	SNR	@OLP; BW = 0.45 F _S	127			dB
Dynamic Range	DNR	@MIL; F _S = 48 kHz; per AES17	135			dB
MODULATOR: ORDER 4, 256x OSR						
Overload Point	OLP	1 kHz			-8.0	dBFS
Total Harm. Dist. + Noise		@OLP; BW = 0.45 F _S			-130	dB
Signal-to-Noise Ratio	SNR	@OLP; BW = 0.45 F _S	129			dB
Dynamic Range	DNR	@MIL; F _S = 48 kHz; per AES17	137			dB
MODULATOR: ORDER 5, 256x OSR						
Overload Point	OLP	1 kHz			-9.8	dBFS
Total Harm. Dist. + Noise		@OLP; BW = 0.45 F _S			-128	dB
Signal-to-Noise Ratio	SNR	@OLP; BW = 0.45 F _S	127			dB
Dynamic Range	DNR	@MIL; F _S = 48 kHz; per AES17	137			dB

Parameter	Symbol	Test Conditions	Min	Typ	Max	Unit
MODULATOR: ORDER 4, 512x OSR						
Overload Point	OLP	1 kHz			-8.2	dBFS
Total Harm. Dist. + Noise		@OLP; BW = 0.45 F _S			-130	dB
Signal-to-Noise Ratio	SNR	@OLP; BW = 0.45 F _S	129			dB
Dynamic Range	DNR	@MIL; F _S = 48 kHz; per AES17	137			dB
MODULATOR: ORDER 5, 512x OSR						
Overload Point	OLP	1 kHz			-10	dBFS
Total Harm. Dist. + Noise		@OLP; BW = 0.45 F _S			-128	dB
Signal-to-Noise Ratio	SNR	@OLP; BW = 0.45 F _S	127			dB
Dynamic Range	DNR	@MIL; F _S = 48 kHz; per AES17	137			dB
RECEIVER						
Decimated Rate	F _S		0.160		768	kHz
Bit Clock Rate	F _B	Master or slave mode	0.128		24.576	MHz
DECIMATION FILTER						
Decimation Ratio (FB/FS)	DECR	1, 3, 12.5, 4, 6.25, 8.00, 8.33, 10.67, 12.5, 16, 16.67, 18.75, 21.33, 24, 25, 32, 33.33, 37.5, 42.67, 48, 50, 64, 66.67, 75, 85.33, 96, 100, 128, 150, 192, 200, 256, 300, 384, 400, 512, 500, 768, 800	1		800	
Passband Frequency Range		All DECR except DECR = 1	0		0.45	F _S
		DECR = 1	0		0.5	F _B
Passband Gain		DECR = 1, 4, 8, 16, 32, 64, 128, 256, 512	-0.001		+0.001	dB
		All other DECR	-0.005		+0.005	dB
Stopband Frequency Range		All DECR except DECR = 1	0.55		DECR/2	F _S
Stopband Attenuation		All DECR except DECR = 1	120			dB

Parameter	Symbol	Test Conditions	Min	Typ	Max	Unit
LOGIC LEVEL						
Interface Voltage	V_{INT}		0.80		3.30	V
Resolution					0.01	V
Accuracy				±0.05		V
OUTPUT CHARACTERISTICS						
Output Voltage High	V_{OH}	$I_{LOAD} = 0.5 \text{ mA}$	$0.7 \cdot V_{INT}$			V
Output Voltage Low	V_{OL}	$I_{LOAD} = 0.5 \text{ mA}$			$0.3 \cdot V_{INT}$	V
VDD OUTPUT						
DC Voltage	V_{DD}		0.80		3.60	V
Resolution					0.01	V
Accuracy				±0.05		V
Maximum Current	I_{MAX}				15	mA
VDD MODULATION						
AC output level		All waveforms	0.01		$V_{DD} / 5$	V_{pp}
Square/Pulse Frequency		Per GSM standard		216.667		Hz
Sine Frequency			10		22000	Hz
Frequency Accuracy				3		ppm

Parameter	Symbol	Test Conditions	Min	Typ	Max	Unit
<u>Timing Characteristics</u>						
PDM TRANSMITTER						
t_{CLKTX}		Clock period (master or slave mode)	41		7813	ns
t_H		Data hold time	20			ns
t_{SU}		Data setup time		$t_{CLKTX} / 2-30$		ns
Logic Level = 0.8 V						
t_{CO}		Clock to out		58		ns
t_R		Rise Time		18		ns
t_F		Fall Time		16		ns
r_{OUT}		Output Impedance		450		ohms
$f_{CLK\ max}$		Maximum Clock Frequency		3.072		MHz
Logic Level = 1.0 V						
t_{CO}		Clock to out		32		ns
t_R		Rise Time		10		ns
t_F		Fall Time		7.7		ns
r_{OUT}		Output Impedance		225		ohms
$f_{CLK\ max}$		Maximum Clock Frequency		6.144		MHz
Logic Level = 1.5 V						
t_{CO}		Clock to out		18		ns
t_R		Rise Time		5.2		ns
t_F		Fall Time		3.8		ns
r_{OUT}		Output Impedance		85		ohms
$f_{CLK\ max}$		Maximum Clock Frequency		12.28		MHz

Parameter	Symbol	Test Conditions	Min	Typ	Max	Unit
Logic Level ≥ 2.0 V						
t_{CO}		Clock to out		15		ns
t_R		Rise Time		3.9		ns
t_F		Fall Time		2.9		ns
r_{OUT}		Output Impedance		40		ohms
$f_{CLK\ max}$		Maximum Clock Frequency		24.576		MHz

PDM RECEIVER

t_{CLKRX}		Clock period (master or slave mode)	41		7813	ns
t_{HP}		Data hold time, rising edge		5		ns
t_{HN}		Data hold time, falling edge		5		ns
t_{SU}		Data setup time			5	ns

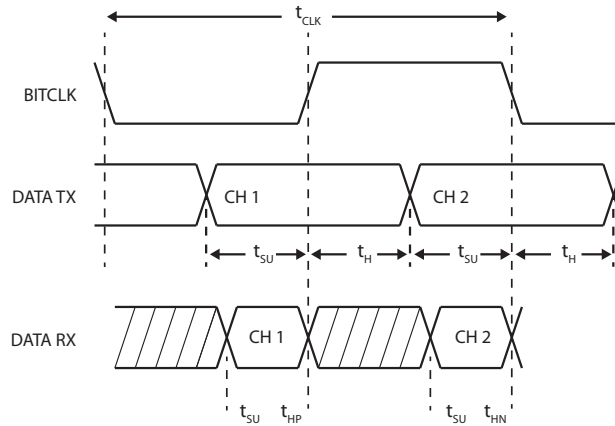

Parameter	Symbol	Test Conditions	Min	Typ	Max	Unit
<u>Clock Jitter (Advanced Master Clock required)</u>						
Jitter Measurement						
Range				0 to 650 ns		
Detection		Peak, RMS or Average				
<u>Bandwidth</u>						
Low Limit				50 Hz or 700 Hz		
High Limit		Variable in 0.1 kHz steps, Butterworth or Elliptic response	1 kHz		150 kHz	
Accuracy (1 kHz)		“Average” detection		±(1% + 300 ps)		
Flatness ¹		100 Hz to 100 kHz			±0.2 dB	
Residual Jitter ¹		700 Hz to 100 kHz BW			≤600 ps	
Jitter Spectrum ¹				Spurious products are typically -40 dBc (below jitter signal) or -60 dBUI, whichever is larger. ²		
PDM Input Jitter Tolerance		Sine wave jitter, bit clock rates from 128kHz to 24.576 MHz.	3.5 UI, (subject to 1591 ns max jitter limit)			
Induced Jitter						
Waveforms		Sine, Square, Noise				
Signals Affected		Bit Clk and Data				

Parameter	Symbol	Test Conditions	Min	Typ	Max	Unit
<u>Sine Wave Jitter</u>						
Frequency Range (f _j)			2 Hz		200 kHz	
Amplitude Range		Referenced to bit clock rate, subject to linear derating at jitter frequencies >20kHz		3.5 UI or 1591 ns which ever is less		
Amplitude Resolution			100 ps			
Accuracy (1 kHz)			±0.01%			
Flatness			±0.01%			
Jitter Spectrum ¹				Spurious products are typically -40 dBc (below jitter signal) or -60 dBUI, whichever is larger. ²		
<u>Square Wave and Noise Waveform Jitter</u>						
				Jitter amplitude limited to 40 ns maximum.		
PDM Output Jitter Tolerance		Sine wave jitter, bit clock rates from 128kHz to 24.576 MHz		3.5 UI (subject to 1591ns max jitter limit)		

Notes to Specifications

1. System specification including contributions from both generator and analyzer subject to the following condition: Bit Clock ≥ 192 kHz.
2. For PDM, the Unit Interval (UI) is defined as 1/f_b, where f_b is the bitclock rate in hertz.

PDM 16 input module specifications

with APx500 v5.0.3 or higher measurement software
as fitted in APx52x, 555 and 58x B Series audio analyzers
NP0020.00046 rev 000
November 2019

PDM 16

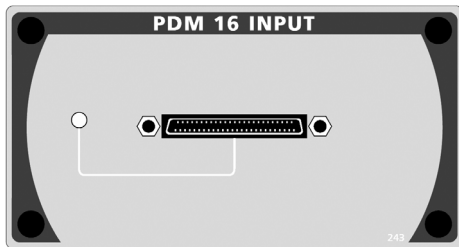

This illustration shows the PDM 16 module, model 243, and PDM 16 remote interface pod.

The PDM 16 option provides a solution for addressing circuits or devices with multiple PDM outputs. The PDM 16 option provides up to 16 acquisition channels that connect through the module's PDM 16 remote interface pod. All 16 channels can be measured simultaneously to provide sample-accurate interchannel information. The input accepts 1-bit PDM bitstreams, which are then decimated by one of several available decimation ratios and filtered into baseband audio at the Decimated Rate. The PDM 16 also provides a variable Vdd supply (0.0 V-3.6 V, 50 mA max.) and a bit clock that can be configured as an input or an output.

The PDM 16 remote interface pod provides a 40-pin, 0.1" (2.54mm) pitch IDC connector as an interface to PDM MEMS microphones. All signal pins are provided with individual, shared grounds. All clock outputs are redundant but individually buffered to drive multiple clock inputs if required. The Vdd output provides DC power, if required, for the device under test. The 8 data input pins can be used to interface up to 16 microphones simultaneously. The input is compatible with commonly available IDE / parallel ATA I/O cables.

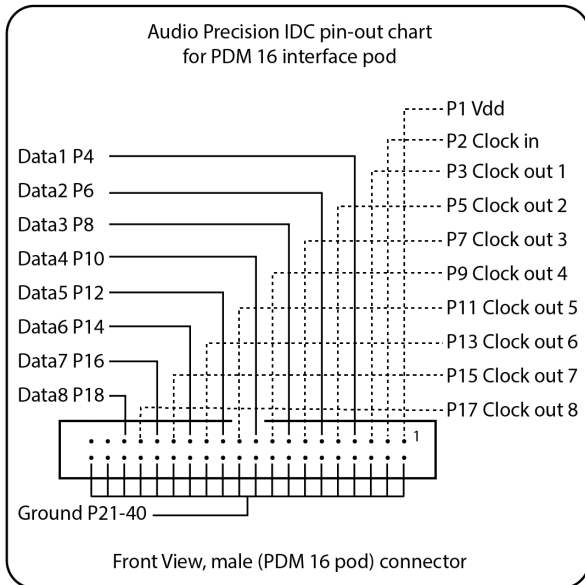

These specifications cover the digital input functions of the Audio Precision PDM 16 interface for the current version, model 243.

PDM 16 specifications begin on the next page.

Technical Specifications

Parameter	Symbol	Test Conditions	Min	Type	Max	Unit
RECEIVER						
Remote Input Pod		Instrument to pod cable lengths of 2 m, 5 m and 10 m available				
Data Lines			1		8	
Channels			1		16	
Decimated Rate	F_S		4		192	kHz
Bit Clock Rate	F_B	Master or slave mode	0.128		24.576	MHz
Clock Outputs		1 master clock source replicated on 8 outputs			8	
Clock Inputs		1 slave clock input shared across all 8 data lines			1	
Phase/Synchronization		All channels sampled synchronously from common clock, phase relationships between channels fully maintained				
DECIMATION FILTER						
Decimation Ratio (FB/FS)	DECR	32, 64, 128, 256, 512	32		512	
Passband Frequency Range			0		0.45	F_S
Passband Gain		DECR = 64, 128, 256, 512	-0.001		+0.001	dB
Passband Gain		DECR = 32	-0.01		+0.01	dB
Stopband Frequency Range			0.55		DECR/2	F_S
Stopband Attenuation			120			dB

DISTORTION, NOISE and DYNAMIC RANGE (when tested with APx PDM Module output)¹

MODULATOR: ORDER 4, 64X OSR

Parameter	Symbol	Test Conditions	Min	Type	Max	Unit
Overload Point	OLP	1 kHz			-7.8	dBFS
Total Harm. Dist. + Noise		@OLP; BW = 0.45 FS			-105	dB
Signal-to-Noise Ratio	SNR	@OLP; BW = 0.45 FS	106			dB
Dynamic Range	DNR	@MIL; FS = 48 kHz, per AES17	115			dB
MODULATOR: ORDER 5, 64X OSR						
Overload Point	OLP	1 kHz			-9.4	dBFS
Total Harm. Dist. + Noise		@OLP; BW = 0.45 FS			-116	dB
Signal-to-Noise Ratio	SNR	@OLP; BW = 0.45 FS	116			dB
Dynamic Range	DNR	@MIL; FS = 48 kHz, per AES17	125			dB
MODULATOR: ORDER 4, 128X OSR						
Overload Point	OLP	1 kHz			-7.9	dBFS
Total Harm. Dist. + Noise		@OLP; BW = 0.45 FS			-127	dB
Signal-to-Noise Ratio	SNR	@OLP; BW = 0.45 FS	127			dB
Dynamic Range	DNR	@MIL; FS = 48 kHz, per AES17	135			dB
MODULATOR: ORDER 5, 128X OSR						
Overload Point	OLP	1 kHz			-9.6	dBFS
Total Harm. Dist. + Noise		@OLP; BW = 0.45 FS			-127	dB
Signal-to-Noise Ratio	SNR	@OLP; BW = 0.45 FS	127			dB
Dynamic Range	DNR	@MIL; FS = 48 kHz, per AES17	135			dB
MODULATOR: ORDER 4, 256X OSR						
Overload Point	OLP	1 kHz			-8.0	dBFS
Total Harm. Dist. + Noise		@OLP; BW = 0.45 FS			-130	dB

Parameter	Symbol	Test Conditions	Min	Type	Max	Unit
Signal-to-Noise Ratio	SNR	@OLP; BW = 0.45 FS	129			dB
Dynamic Range	DNR	@MIL; FS = 48 kHz, per AES17	137			dB
MODULATOR: ORDER 5, 256X OSR						
Overload Point	OLP	1 kHz			-9.8	dBFS
Total Harm. Dist. + Noise		@OLP; BW = 0.45 FS			-128	dB
Signal-to-Noise Ratio	SNR	@OLP; BW = 0.45 FS	127			dB
Dynamic Range	DNR	@MIL; FS = 48 kHz, per AES17	137			dB
MODULATOR: ORDER 4, 512X OSR						
Overload Point	OLP	1 kHz			-8.2	dBFS
Total Harm. Dist. + Noise		@OLP; BW = 0.45 FS			-130	dB
Signal-to-Noise Ratio	SNR	@OLP; BW = 0.45 FS	129			dB
Dynamic Range	DNR	@MIL; FS = 48 kHz, per AES17	137			dB
MODULATOR: ORDER 5, 512X OSR						
Overload Point	OLP	1 kHz			-10	dBFS
Total Harm. Dist. + Noise		@OLP; BW = 0.45 FS			-128	dB
Signal-to-Noise Ratio	SNR	@OLP; BW = 0.45 FS	127			dB
Dynamic Range	DNR	@MIL; FS = 48 kHz, per AES17	137			dB
<u>INPUT CHARACTERISTICS</u>						
Impedance				>100 < 10		kOhms pf
Input Voltage Range			0		5	V
Interface Voltage (Logic Level)	VINT		0.8		3.30	V

Parameter	Symbol	Test Conditions	Min	Type	Max	Unit
Resolution					0.01	V
Accuracy			±0.05			V
<u>OUTPUT CHARACTERISTICS</u>						
Output Voltage High	VOH	ILOAD = 0.5 mA	0.7 × VINT			V
Output Voltage Low	VOL	ILOAD = 0.5 mA			0.3 × VINT	V
Output Impedance	Zo	At connector pin	50			Ohms
VDD OUTPUT						
DC Voltage	VDD		0.0		3.60	V
Resolution					0.01	V
Accuracy			±0.05			V
Maximum Current	IMAX				50	mA
<u>TIMING CHARACTERISTICS</u>						
PDM RECEIVER						
t _{CLKRX}		Clock period (master or slave mode)	41		7813	ns
t _{HP}		Data hold time, rising edge	0			ns
t _{HN}		Data hold time, falling edge	0			ns
t _{SU}		Data setup time			9	ns
PDM Input Jitter Tolerance		Sine wave jitter, bit clock rates from 128kHz to 24.576 MHz		<= 3.5 UI (subject to 1591ns max jitter limit)		UI ²

Notes to Specifications

- System specification including contributions from both generator and analyzer subject to the following condition: Bit Clock ≥ 192 kHz.
- For PDM, the Unit Interval (UI) is defined as 1/fb, where fb is the bitclock rate in hertz.



Audio Precision, Inc.
5750 SW Arctic Drive
Beaverton, Oregon 97005

800-231-7350